

53-1003169-01
27 June 2014



Web Tools

Administrator's Guide

Supporting Fabric OS v7.3.0

BROCADE

© 2014, Brocade Communications Systems, Inc. All Rights Reserved.

Brocade, the B-wing symbol, Brocade Assurance, ADX, AnyIO, DCX, Fabric OS, FastIron, HyperEdge, ICX, MLX, MyBrocade, NetIron, OpenScript, VCS, VDX, and Vyatta are registered trademarks, and The Effortless Network and the On-Demand Data Center are trademarks of Brocade Communications Systems, Inc., in the United States and in other countries. Other brands and product names mentioned may be trademarks of others.

Notice: This document is for informational purposes only and does not set forth any warranty, expressed or implied, concerning any equipment, equipment feature, or service offered or to be offered by Brocade. Brocade reserves the right to make changes to this document at any time, without notice, and assumes no responsibility for its use. This informational document describes features that may not be currently available. Contact a Brocade sales office for information on feature and product availability. Export of technical data contained in this document may require an export license from the United States government.

The authors and Brocade Communications Systems, Inc. assume no liability or responsibility to any person or entity with respect to the accuracy of this document or any loss, cost, liability, or damages arising from the information contained herein or the computer programs that accompany it.

The product described by this document may contain open source software covered by the GNU General Public License or other open source license agreements. To find out which open source software is included in Brocade products, view the licensing terms applicable to the open source software, and obtain a copy of the programming source code, please visit <http://www.brocade.com/support/oscd>.

Contents

Preface.....	13
Document conventions.....	13
Text formatting conventions.....	13
Command syntax conventions.....	13
Notes, cautions, and warnings.....	14
Brocade resources.....	15
Contacting Brocade Technical Support.....	15
Document feedback.....	16
About This Document	17
Supported hardware and software.....	17
What's new in this document.....	18
Introducing Web Tools.....	19
Web Tools overview.....	19
Web Tools, the EGM license, and Brocade Network Advisor.....	19
Web Tools features enabled by the EGM license.....	20
Web Tools functionality moved to Brocade Network Advisor.....	21
System requirements.....	23
Setting refresh frequency for Internet Explorer.....	24
Deleting temporary Internet files used by Java applications.....	25
Java installation on the workstation.....	26
Installing the JRE on your Solaris or Linux client workstation.....	26
Installing patches on Solaris.....	26
Installing the Java Plug-in on Windows.....	27
Java Plug-in configuration.....	27
Enabling Java content in the browser.....	27
Configuring the Java Plug-in for Windows.....	27
Configuring the Java Plug-in for Mozilla family browsers.....	28
Value line licenses.....	28
Opening Web Tools.....	29
Logging in.....	29
Logging out.....	32
Role-Based Access Control.....	32
Session management.....	33
Ending a Web Tools session.....	33
Web Tools system logs	33
SupportSave logs.....	34
Requirements for IPv6 support.....	35
Using the Web Tools Interface.....	37
Viewing Switch Explorer.....	37
Persisting GUI preferences.....	39
Tabs.....	40
Fabric Tree.....	40
Changing the Admin Domain context.....	41
Switch View buttons.....	41

Switch View.....	41
Switch Events and Switch Information.....	43
Free Professional Management tool.....	45
Displaying tool tips.....	45
Right-click options.....	45
Refresh rates.....	46
Displaying switches in the fabric.....	47
Recommendations for working with Web Tools.....	47
Opening a Telnet or SSH client window.....	48
Collecting logs for troubleshooting.....	48
Managing Fabrics and Switches.....	51
Fabric and switch management overview.....	51
Opening the Switch Administration window.....	52
Configuring IP and subnet mask information.....	53
Configuring Netstat Auto Refresh.....	54
Configuring a syslog IP address.....	54
Removing a syslog IP address.....	55
Configuring IP filtering.....	55
Blade management.....	56
Enabling or disabling a blade.....	56
Setting a slot-level IP address.....	57
Viewing IP addresses.....	58
Switch configuration.....	58
Enabling and disabling a switch.....	58
Enabling and disabling switch persistent.....	58
Changing the switch name.....	59
Changing the switch domain ID.....	59
Viewing and printing a switch report.....	60
Setting a principal switch.....	60
Switch restart.....	61
Performing a fast boot.....	61
Performing a reboot.....	61
System configuration parameters.....	62
WWN-based persistent PID assignment.....	62
Configuring fabric settings.....	63
Enabling insistent domain ID mode.....	64
Configuring virtual channel settings.....	64
Configuring arbitrated loop parameters.....	65
Configuring system services.....	66
Configuring CCTL QoS mode.....	66
Configuring signed firmware.....	66
Licensed feature management.....	67
Activating a license on a switch.....	67
Assigning slots for a license key.....	67
Removing a license from a switch.....	68
Universal time-based licensing.....	68
High Availability overview.....	69
Admin Domain considerations.....	69
Launching the High Availability window.....	69
Synchronizing services on the CP.....	70
Initiating a CP failover.....	71
Event monitoring.....	71
Displaying switch events.....	72
Filtering switch events.....	72
Filtering events by event severity levels.....	73
Filtering events by message ID.....	73

Filtering events by service component.....	73
Displaying the Name Server entries.....	74
Printing the Name Server entries.....	74
Displaying Name Server information for a particular device.....	74
Displaying zone members for a particular device.....	75
Physically locating a switch using beaconing.....	75
Locating logical switches using chassis beaconing.....	75
Virtual Fabrics overview.....	76
Selecting a logical switch from the Switch View.....	76
Viewing logical ports.....	77
Maintaining Configurations and Firmware.....	79
Creating a configuration backup file.....	79
Restoring a configuration.....	80
Admin Domain configuration maintenance.....	81
Uploading and downloading from USB storage.....	82
Performing a firmware download.....	82
Managing Administrative Domains.....	85
Administrative Domain overview.....	85
Requirements for Admin Domains.....	85
User-defined Admin Domains.....	85
System-defined Admin Domains.....	86
Admin Domain membership.....	87
Enabling Admin Domains.....	87
Admin Domain window.....	87
Opening the Admin Domain window.....	89
Refreshing fabric information.....	89
Refreshing Admin Domain information.....	89
Saving local Admin Domain changes.....	90
Closing the Admin Domain window.....	90
Creating and populating domains.....	90
Creating an Admin Domain.....	91
Adding ports or switches to the fabric.....	91
Activating or deactivating an Admin Domain.....	92
Modifying Admin Domain members.....	92
Renaming Admin Domains.....	93
Deleting Admin Domains.....	93
Clearing the Admin Domain configuration.....	93
Managing Ports.....	95
Port management overview.....	95
Opening the Port Admin tab.....	95
Port Admin tab components.....	96
Controllable ports.....	99
Configuring FC ports.....	99
Allowed port types.....	100
Speed.....	101
Long distance mode.....	101
Ingress rate limit.....	101
Available buffer credit calculation.....	103
Assigning a name to a port.....	103
Port beaconing.....	103
Enabling and disabling a port.....	104
Considerations for enabling or disabling a port.....	104

Persistent enabling and disabling ports.....	105
Configuring NPIV ports.....	106
Port activation.....	106
Enabling Ports on Demand.....	108
Enabling Dynamic Ports on Demand.....	108
Disabling Dynamic Ports on Demand.....	108
Diagnostic ports.....	109
Reserving and releasing licenses on a port basis.....	109
Port swapping index.....	110
Port swapping.....	110
Determining if a port index was swapped with another switch port.....	111
Configuring port binding.....	112
Unbinding a port.....	113
Configuring BB credits on an F_Port.....	113
Configuring ALPA	114
Configuring port octet speed combination	115
Configuring CSCTL.....	116
Enabling CSCTL mode.....	117
Disabling CSCTL mode.....	117
Configuring compression and encryption.....	117
Enabling or disabling encryption.....	118
Enabling or disabling compression.....	118
Displaying compression ratio.....	118
Forward Error Correction.....	119
In-Band Management.....	119
GigE port modes.....	120
Enabling ISL Trunking.....	121
ISL Trunking overview.....	121
Disabling or enabling ISL Trunking	121
Admin Domain considerations.....	122
Viewing trunk group information.....	122
F_Port trunk groups.....	123
Creating and maintaining F_Port trunk groups.....	123
Monitoring Performance.....	125
Performance Monitor overview.....	125
Basic monitoring	125
Advanced monitoring.....	125
Performance graphs.....	126
Admin Domain considerations.....	126
Predefined performance graphs.....	126
User-defined graphs.....	129
Canvas configurations.....	129
Opening the Performance Monitor window.....	130
Creating basic performance monitor graphs.....	130
Customizing basic monitoring graphs.....	131
Advanced performance monitoring graphs.....	133
Creating SID/DID Performance graphs.....	133
Creating the SCSI vs. IP Traffic graph.....	134
Creating SCSI command graphs.....	134
Tunnel and TCP performance monitoring graphs.....	135
Tunnel and TCP graph chart properties.....	136
Saving graphs to a canvas.....	136
Adding graphs to an existing canvas.....	137

Printing graphs.....	137
Modifying graphs.....	137
Administering Zoning.....	139
Zoning overview.....	139
Basic zones.....	139
Traffic Isolation zones.....	139
LSAN zone requirements.....	139
QoS zone requirements.....	140
Zoning configurations	140
Opening the Zone Admin window.....	140
Setting the default zoning mode.....	140
Zoning management.....	141
Refreshing fabric information.....	144
Refreshing Zone Administration window information.....	144
Saving local zoning changes.....	145
Selecting a zoning view.....	145
Creating and populating zone aliases.....	146
Adding and removing members of a zone alias.....	146
Renaming zone aliases.....	147
Deleting zone aliases.....	147
Creating and populating zones.....	148
Adding and removing members of a zone.....	148
Renaming zones.....	149
Cloning zones.....	149
Deleting zones.....	149
Creating and populating enhanced Traffic Isolation zones.....	150
Zone configuration and zoning database management.....	151
Creating zone configurations.....	151
Adding or removing zone configuration members.....	152
Renaming zone configurations.....	152
Cloning zone configurations.....	153
Deleting zone configurations.....	153
Enabling zone configurations.....	153
Disabling zone configurations.....	154
Displaying enabled zone configurations.....	154
Viewing the enabled zone configuration name without opening the Zone Administration window.....	155
Viewing detailed information about the enabled zone configuration.....	155
Adding a WWN to multiple aliases and zones.....	155
Removing a WWN from multiple aliases and zones.....	156
Replacing a WWN in multiple aliases and zones.....	156
Searching for zone members.....	157
Clearing the zoning database.....	157
Zone configuration analysis.....	157
Best practices for zoning.....	158
Working with Diagnostic Features.....	159
Trace dumps.....	159
How a trace dump is used.....	159
Setting up automatic trace dump transfers.....	160
Specifying a remote server.....	160
Enabling automatic transfer of trace dumps.....	160
Disabling automatic trace uploads.....	160
Displaying switch information.....	161
Viewing detailed fan hardware status.....	162

Viewing the temperature status.....	162
Viewing the power supply status.....	163
Checking the physical health of a switch.....	163
Defining switch policy.....	165
Port LED interpretation.....	166
Port icon colors.....	166
Using the FC-FC Routing Service.....	167
Fibre Channel Routing overview.....	167
Supported switches for Fibre Channel Routing.....	168
Setting up FC-FC routing.....	168
FC-FC routing management.....	169
Opening the FC Routing module.....	169
Viewing and managing LSAN fabrics.....	170
Viewing EX_Ports.....	170
Configuring an EX_Port.....	171
Editing the configuration of an EX_Port.....	171
Configuring FCR router port cost.....	172
Viewing LSAN zones.....	172
Viewing LSAN devices.....	172
Configuring the backbone fabric ID.....	173
Using the Access Gateway.....	175
Access Gateway overview.....	175
Viewing Switch Explorer for Access Gateway mode.....	175
Access Gateway mode	176
Restricted access in the Port Admin tab.....	176
Enabling Access Gateway mode.....	177
Disabling Access Gateway mode.....	177
Viewing the Access Gateway settings.....	178
Port configuration.....	178
Editing a Port.....	178
Creating port groups.....	179
Editing or viewing port groups.....	180
Deleting port groups.....	181
Defining custom primary F-N port mapping.....	181
Defining custom static F-N port mapping.....	181
Defining custom WWN-N port mappings.....	182
Access Gateway policy modification.....	182
Path Failover and Failback policies.....	182
Modifying Path Failover and Failback policies.....	182
Enabling the Automatic Port Configuration policy.....	183
Administering Fabric Watch.....	185
Fabric Watch overview.....	185
Administering Extended Fabrics.....	187
Extended link buffer allocation overview.....	187
Configuring a port for long distance.....	189
Routing Traffic.....	191
Routing overview.....	191

Viewing fabric shortest path first routing.....	192
Configuring dynamic load sharing.....	193
Lossless dynamic load sharing.....	193
Specifying frame order delivery.....	194
Configuring the link cost for a port.....	194
Configuring Standard Security Features.....	197
User-defined accounts.....	197
Virtual Fabrics considerations.....	198
Admin Domain considerations.....	198
Viewing user account information.....	199
Creating user-defined accounts.....	199
Deleting user-defined accounts.....	202
Changing user account parameters	202
Maintaining passwords.....	204
User-defined roles.....	206
Guidelines and restrictions.....	206
Creating a user-defined role.....	207
Editing a user-defined role.....	208
Access control list policy configuration.....	209
Virtual Fabrics considerations.....	209
Admin Domain considerations.....	209
Creating an SCC, DCC, or FCS policy.....	209
Editing an SCC, DCC, or FCS policy.....	210
Deleting all SCC, DCC, or FCS policies.....	210
Activating all SCC, DCC, or FCS policies.....	210
Distributing an SCC, DCC, or FCS policy.....	211
Moving an FCS policy switch position.....	211
Configuring Advanced Device Security policy	211
Fabric-Wide Consistency Policy configuration.....	212
Authentication policy configuration.....	213
Configuring authentication policies for E_Ports.....	213
Configuring authentication policies for F_Ports.....	213
Distributing authentication policies.....	214
Re-authenticating policies.....	214
Setting a shared secret key pair.....	214
Modifying a shared secret key pair.....	215
Setting the Switch Policy Authentication mode.....	215
SNMP configuration.....	215
Setting SNMP trap levels.....	215
Changing the systemGroup configuration parameters.....	216
Setting SNMPv1 configuration parameters.....	216
Setting SNMPv3 configuration parameters.....	216
Changing the access control configuration.....	217
RADIUS management.....	217
Enabling and disabling RADIUS.....	218
Configuring RADIUS.....	218
Modifying the RADIUS server.....	219
Modifying the RADIUS server order.....	219
Removing a RADIUS server.....	220
Active Directory service management.....	220
Enabling Active Directory service.....	220
Modifying Active Directory service.....	221
Removing Active Directory service.....	221
TACACS+ management.....	221
Enabling and disabling TACACS+.....	221
Configuring TACACS+.....	222

Modifying TACACS+.....	222
Removing TACACS+.....	222
IPsec concepts.....	223
Transport mode and tunnel mode.....	224
IPsec header options.....	224
Basic IPsec configurations.....	225
Internet Key Exchange concepts.....	226
IPsec over management ports.....	228
Enabling the Ethernet IPsec policies	228
Establishing an IKE policy.....	229
Creating a security association.....	229
Creating an SA proposal.....	230
Adding an IPsec transform policy.....	230
Adding an IPsec selector.....	231
Manually creating an SA.....	231
Editing an IKE or IPsec policy.....	232
Deleting an IKE or IPsec policy.....	232
Establishing authentication policies for HBAs.....	233
Administering FICON CUP Fabrics.....	235
FICON CUP fabrics overview.....	235
Enabling port-based routing.....	236
Enabling or disabling FICON Management Server mode.....	237
FMS parameter configuration.....	237
Configuring FMS mode parameters.....	238
Displaying code page information.....	239
Viewing the control device state.....	239
Allow / Prohibit Matrix configuration.....	240
Viewing Allow / Prohibit Matrix configurations.....	241
Modifying Allow / Prohibit Matrix configurations.....	241
Activating an Allow / Prohibit Matrix configuration.....	242
Copying an Allow / Prohibit Matrix configuration.....	243
Deleting an Allow / Prohibit Matrix configuration.....	243
CUP logical path configuration.....	243
Viewing CUP logical path configurations.....	243
Configuring CUP logical paths.....	244
Link Incident Registered Recipient configuration.....	244
Viewing Link Incident Registered Recipient configurations.....	244
Configuring LIRRs.....	244
Displaying Request Node Identification Data	245
Configuring FCoE with Web Tools.....	247
Web Tools and FCoE overview.....	247
Web Tools, the EGM license, and Brocade Network Advisor.....	247
Port information that is unique to FCoE.....	248
Switch administration and FCoE.....	248
FCoE configuration tasks.....	249
Quality of Service configuration.....	249
Editing the DCB map.....	249
Adding a traffic class map.....	250
LLDP-DCBX configuration.....	250
Configuring global LLDP characteristics.....	251
Adding an LLDP profile.....	252
Configuring DCB interfaces.....	253
Configuring a link aggregation group	254
Configuring VLANs.....	254

Configuring FCoE login groups.....	255
Displaying FCoE port information.....	256
Displaying LAG information.....	257
Displaying VLAN information.....	257
Displaying FCoE login groups.....	257
Displaying QoS information.....	257
Displaying LLDP-DCBX information.....	257
Displaying DCB interface statistics.....	258
Configuring a DCB interface from the Switch View.....	258
Configuring a DCB interface from the Port Admin panel.....	258
Enabling and disabling a LAG.....	259
Enabling and disabling LLDP.....	259
Enabling and disabling QoS priority-based flow control.....	259
Enabling and disabling FCoE ports.....	260
Limitations.....	261
General Web Tools limitations.....	261
Index.....	267

Preface

- Document conventions..... 13
- Brocade resources..... 15
- Contacting Brocade Technical Support..... 15
- Document feedback..... 16

Document conventions

The document conventions describe text formatting conventions, command syntax conventions, and important notice formats used in Brocade technical documentation.

Text formatting conventions

Text formatting conventions such as boldface, italic, or Courier font may be used in the flow of the text to highlight specific words or phrases.

Format	Description
bold text	Identifies command names Identifies keywords and operands Identifies the names of user-manipulated GUI elements Identifies text to enter at the GUI
<i>italic text</i>	Identifies emphasis Identifies variables and modifiers Identifies paths and Internet addresses Identifies document titles
<code>Courier font</code>	Identifies CLI output Identifies command syntax examples

Command syntax conventions

Bold and italic text identify command syntax components. Delimiters and operators define groupings of parameters and their logical relationships.

Convention	Description
bold text	Identifies command names, keywords, and command options.
<i>italic text</i>	Identifies a variable.

Convention	Description
value	In Fibre Channel products, a fixed value provided as input to a command option is printed in plain text, for example, --show WWN .
[]	Syntax components displayed within square brackets are optional. Default responses to system prompts are enclosed in square brackets.
{ x y z }	A choice of required parameters is enclosed in curly brackets separated by vertical bars. You must select one of the options. In Fibre Channel products, square brackets may be used instead for this purpose.
x y	A vertical bar separates mutually exclusive elements.
< >	Nonprinting characters, for example, passwords, are enclosed in angle brackets.
...	Repeat the previous element, for example, <i>member[member...]</i> .
\	Indicates a "soft" line break in command examples. If a backslash separates two lines of a command input, enter the entire command at the prompt without the backslash.

Notes, cautions, and warnings

Notes, cautions, and warning statements may be used in this document. They are listed in the order of increasing severity of potential hazards.

NOTE

A Note provides a tip, guidance, or advice, emphasizes important information, or provides a reference to related information.

ATTENTION

An Attention statement indicates a stronger note, for example, to alert you when traffic might be interrupted or the device might reboot.



CAUTION

A Caution statement alerts you to situations that can be potentially hazardous to you or cause damage to hardware, firmware, software, or data.



DANGER

A Danger statement indicates conditions or situations that can be potentially lethal or extremely hazardous to you. Safety labels are also attached directly to products to warn of these conditions or situations.

Brocade resources

Visit the Brocade website to locate related documentation for your product and additional Brocade resources.

You can download additional publications supporting your product at www.brocade.com. Select the Brocade Products tab to locate your product, then click the Brocade product name or image to open the individual product page. The user manuals are available in the resources module at the bottom of the page under the Documentation category.

To get up-to-the-minute information on Brocade products and resources, go to [MyBrocade](#). You can register at no cost to obtain a user ID and password.

Release notes are available on [MyBrocade](#) under Product Downloads.

White papers, online demonstrations, and data sheets are available through the [Brocade website](#).

Contacting Brocade Technical Support

As a Brocade customer, you can contact Brocade Technical Support 24x7 online, by telephone, or by e-mail. Brocade OEM customers contact their OEM/Solutions provider.

Brocade customers

For product support information and the latest information on contacting the Technical Assistance Center, go to <http://www.brocade.com/services-support/index.html>.

If you have purchased Brocade product support directly from Brocade, use one of the following methods to contact the Brocade Technical Assistance Center 24x7.

Online	Telephone	E-mail
<p>Preferred method of contact for non-urgent issues:</p> <ul style="list-style-type: none"> • My Cases through MyBrocade • Software downloads and licensing tools • Knowledge Base 	<p>Required for Sev 1-Critical and Sev 2-High issues:</p> <ul style="list-style-type: none"> • Continental US: 1-800-752-8061 • Europe, Middle East, Africa, and Asia Pacific: +800-AT FIBREE (+800 28 34 27 33) • For areas unable to access toll free number: +1-408-333-6061 • Toll-free numbers are available in many countries. 	<p>support@brocade.com</p> <p>Please include:</p> <ul style="list-style-type: none"> • Problem summary • Serial number • Installation details • Environment description

Brocade OEM customers

If you have purchased Brocade product support from a Brocade OEM/Solution Provider, contact your OEM/Solution Provider for all of your product support needs.

- OEM/Solution Providers are trained and certified by Brocade to support Brocade® products.
- Brocade provides backline support for issues that cannot be resolved by the OEM/Solution Provider.

- Brocade Supplemental Support augments your existing OEM support contract, providing direct access to Brocade expertise. For more information, contact Brocade or your OEM.
- For questions regarding service levels and response times, contact your OEM/Solution Provider.

Document feedback

To send feedback and report errors in the documentation you can use the feedback form posted with the document or you can e-mail the documentation team.

Quality is our first concern at Brocade and we have made every effort to ensure the accuracy and completeness of this document. However, if you find an error or an omission, or you think that a topic needs further development, we want to hear from you. You can provide feedback in two ways:

- Through the online feedback form in the HTML documents posted on www.brocade.com.
- By sending your feedback to documentation@brocade.com.

Provide the publication title, part number, and as much detail as possible, including the topic heading and page number if applicable, as well as your suggestions for improvement.

About This Document

- [Supported hardware and software](#)..... 17
- [What's new in this document](#)..... 18

Supported hardware and software

In those instances in which procedures or parts of procedures documented here apply to some switches but not to others, this guide identifies exactly which switches are supported and which are not.

Although many different software and hardware configurations are tested and supported by Brocade Communications Systems, Inc. for Fabric OS v7.3.0, documenting all possible configurations and scenarios is beyond the scope of this document.

The following hardware platforms are supported by this release:

- Brocade 300
- Brocade 5100
- Brocade 5300
- Brocade 5410
- Brocade 5424
- Brocade 5431
- Brocade 5450
- Brocade 5460
- Brocade 5470
- Brocade 5480
- Brocade 6505
- Brocade M6505
- Brocade 6510
- Brocade 6520
- Brocade 6547
- Brocade 7800 Extension Switch
- Brocade 7840 Extension Switch
- Brocade DCX 8510-4 Backbone
- Brocade DCX 8510-8 Backbone
- Brocade DCX Backbone
- Brocade DCX-4S Backbone
- Brocade Encryption Switch
- Brocade VA-40FC

The following blades are supported by this release:

- Brocade CORE 8 blade
- Brocade CP8 blade
- Brocade CR16-4 blade
- Brocade CR16-8 blade
- Brocade CR4S-8 blade

- Brocade FC16-32 port blade
- Brocade FC16-48 port blade
- Brocade FC16-64 port blade
- Brocade FC8-16 port blade
- Brocade FC8-32 port blade
- Brocade FC8-32E port blade
- Brocade FC8-48 port blade
- Brocade FC8-48E port blade
- Brocade FC8-64 port blade
- Brocade FS8-18 encryption blade
- Brocade FX8-24 extension blade

What's new in this document

The following additions and enhancements have been made since this document was last released:

- In-Band Management is not supported in Fabric OS v7.3.0.
- MaximumCommunicationRate and MinimumCommunicationRate is changed to Mbps from Kbps.
- Auto Max speed configuration is supported for all platforms.
- Secure File Transfer Protocol (SFTP) is supported for firmware download, configuration upload, and configuration download.
- Available and recommended buffer credit calculation support in FC Port Configuration and Extended Fabric tab.
- Beginning with Fabric OS v7.3.0, Non DFE is supported in Port Admin.

For further information, refer to the release notes.

Introducing Web Tools

- [Web Tools overview](#)..... 19
- [Web Tools, the EGM license, and Brocade Network Advisor](#)..... 19
- [System requirements](#)..... 23
- [Java installation on the workstation](#)..... 26
- [Java Plug-in configuration](#)..... 27
- [Value line licenses](#)..... 28
- [Opening Web Tools](#)..... 29
- [Role-Based Access Control](#)..... 32
- [Session management](#)..... 33
- [Web Tools system logs](#) 33
- [SupportSave logs](#)..... 34
- [Requirements for IPv6 support](#)..... 35

Web Tools overview

Brocade Web Tools is an embedded graphical user interface (GUI) that enables administrators to monitor and manage single or small fabrics, switches, and ports. Web Tools is launched directly from a web browser, or from the Brocade Network Advisor.

A limited set of features is accessible using Web Tools without a license, and is available free of charge. Additional switch management features are accessible using Web Tools with the Enhanced Group Management (EGM) license. Refer to [Web Tools, the EGM license, and Brocade Network Advisor](#) on page 19 for more information.

Web Tools, the EGM license, and Brocade Network Advisor

Beginning with Fabric OS version 6.1.1, Web Tools functionality is tiered and integrated with Brocade Network Advisor. If you are migrating from a Web Tools release prior to Fabric OS version 6.1.1, this may impact how you use Web Tools.

A Web Tools license is not required, and a basic version of Web Tools is available for free. Additional functionality may be added by obtaining the Enhanced Group Management (EGM) license. [Web Tools features enabled by the EGM license](#) on page 20 compares Basic Web Tools features to Web Tools with the EGM license. The EGM license is only for 8 Gbps platforms, such as the Encryption Switch, and the 300, 5100, 5300, and 7800 switches. For non-8 Gbps platforms, all functionalities are available without the EGM license.

Beginning with Fabric OS version 6.1.1, some Web Tools capabilities are moved from Web Tools to Brocade Network Advisor. [Web Tools functionality moved to Brocade Network Advisor](#) on page 21 summarizes these changes.

Web Tools features enabled by the EGM license

The following table describes those Web Tools features that require the EGM license.

TABLE 1 Basic Web Tools features and EGM licensed features

Feature	Basic Web Tools	Web Tools with EGM License
Active Directory support	yes	yes
AD Context Switching	no	yes
AD filtered views	yes	yes
Admin Domain Management	no	yes
AG Management	yes	yes
Analyze zone config	no	no
Basic Zoning and TI Zoning	yes	yes
Blade Management	yes	yes
Cloning a zone	no	yes
Configuration upload/download	yes	yes
Convenience function from Tools menu	no	no
Device Accessibility Matrix	no	no
Easy to configure iSCSI wizard	yes	yes
Extended Fabric Management	no	yes
F_Port Trunk Management	no	yes
Fabric Events	no	no
Fabric Summary	no	no
Fabric Tree	yes	yes
FCIP Tunnel configuration	no	no
FCIP Tunnel Display	yes	yes
FCR Management	yes	yes
FCR Port Config	yes	yes
FICON CUP Tab	no	yes

TABLE 1 Basic Web Tools features and EGM licensed features (Continued)

Feature	Basic Web Tools	Web Tools with EGM License
FRU Monitoring	yes	yes
High Availability	yes	yes
IP Sec Policies	yes	yes
ISL Trunk Management	no	yes
ISL Trunking information	yes	yes
License Management	yes	yes
Long Distance	no	yes
Logical Switch Context Switching	no	yes
Allow/Prohibit Matrix	no	yes
Performance Monitoring dialog box	no	yes
Port Administration	yes	yes
Print zone database summary	no	no
RBAC	yes	yes
Routing and DLS Configuration	no	yes
Security Policies Tab (like ACL)	yes	yes
Switch Info tab	yes	yes
Switch Status	yes	yes
Switch View right-click options	yes	yes
Trace dump	yes	yes
USB Management	yes	yes
User Management	yes	yes
Verify and troubleshoot accessibility between devices	yes	yes

Web Tools functionality moved to Brocade Network Advisor

The functionality that was moved from Web Tools into Brocade Network Advisor is detailed in the following table.

TABLE 2 Web Tools functionality moved to Brocade Network Advisor

Function	Web Tools 6.1.0	Brocade Network Advisor	Comments
Add Un-Zoned Devices	Zone Admin	Configure > Zoning Reverse Find in the Zoning dialog box provides the view of the zoned and unzoned devices in the fabric if all zone members are selected for Find.	
Analyze Zone Config	Zone Admin	<ol style="list-style-type: none"> Configure > Zoning Reverse Find in the Zoning dialog box provides the view of the zoned and unzoned devices in the fabric if all zone members are selected for Find. Device Tree and Topology: Connected End Devices -- Custom Display from the top level in the main frame provides the device tree and topology view for all the zoned devices if all zones are selected in the active zone configuration. 	
Define Device Alias	Zone Admin	Configure > Zoning	
Device Accessibility Matrix	Zone Admin	Configure > Zoning The Compare dialog box provides the Storage-Host and Host-Storage view in a tree representation that is comparable to the Device Accessibility Matrix when all devices are selected.	
Fabric Events	Monitor > Fabric Events	Monitor > Logs > Events	
Fabric Summary	Reports > Fabric Summary	Monitor > Reports > Fabric Summary Report	
FCIP Tunnel Configuration	Port Admin Module > GigE tab	Configure > FCIP Tunnel	Viewing FCIP tunnels is still supported in Web Tools for Fabric OS v6.1.1, but New, Edit Config, and Delete are only available in Brocade Network Advisor.
GigE Ports Interface	Port Admin Module > GigE tab	Configure > FCIP Tunnel	
GigE Ports Route	Port Admin Module > GigE tab	Configure > FCIP Tunnel	
Non-local switch ports display in zoning tree	Zone AdminAdmin DomainSwitch Admin > DCC policiesPerformance Monitoring	Configure > Zoning	In Web Tools, non-local switch port ID/WWN can be added using text box.

TABLE 2 Web Tools functionality moved to Brocade Network Advisor (Continued)

Function	Web Tools 6.1.0	Brocade Network Advisor	Comments
Remove Offline or Inaccessible Devices	Zone Admin	Configure > Zoning Replace/Replace	All zone members by selecting the offline devices from the zone tree. Offline devices have an unknown overlay badge with good visibility.
Zone database summary print	Zone Admin	Configure > Zoning Zoning report for both online and offline database.	

System requirements

Before you install Web Tools on your workstation, verify that your switches and workstation meet the Web Tools requirements listed in this chapter.

Web Tools requires any browser that conforms to HTML 4.0, JavaScript 1.0, and JRE 1.7.0_55 update or later.

NOTE

If there are multiple JRE versions installed, go to the Java Control Panel and uncheck the lower JRE versions for Web Tools to launch using the latest JRE version.

Brocade has certified and tested Web Tools on the platforms shown in the following table.

TABLE 3 Certified and tested platforms

Operating System	Browser
Windows Server 2008 (SP2) Standard (32-bit)	Firefox 26.0, Internet Explorer 9.0, Chrome 33
Windows 8.1 Enterprise (32-bit)	Firefox 26.0, Internet Explorer 10.0/11.0, Chrome 33
Windows 2012 R2	Firefox 26.0, Internet Explorer 11.0, Chrome 33
Windows 7 Service Pack 1 (SP1)	Firefox 26.0, Internet Explorer 9.0/10.0/11.0, Chrome 33
SUSE Linux Enterprise Server 11.3	Firefox 26.0
Windows Server 2008 R2 (SP1) Enterprise (64-bit)	Firefox 26.0, Internet Explorer 9.0/10.0, Chrome 33
Windows Server 2012 Standard (64-bit)	Firefox 26.0, Internet Explorer 10.0/11.0, Chrome 33
Red Hat Enterprise Linux 6.3 Advanced Platform (64-bit)	Firefox 26.0
Red Hat Enterprise Linux 6.5 Advanced Platform (64-bit)	Firefox 26.0
Oracle Enterprise Linux 6.5 Platform (64-bit)	Firefox 26.0

Brocade supports the platforms shown in the following table.

TABLE 4 Supported platforms

Operating System	Browser
Red Hat AS 4.0 (x86 32-bit)	Firefox 12.0
Red Hat Enterprise Linux 6.1 Adv (32-bit)	
Red Hat Enterprise Server 5 Advanced Platform	
SUSE Linux Enterprise Server 10 (32-bit)	
SUSE Linux Enterprise Server 11 (x86 32-bit)	
SUSE Linux Enterprise Server 11 (SP2) (32-bit)	Firefox 26.0
Windows 2000	Firefox 12.0, Internet Explorer 9.0
Windows 2003 Server, SP2	Firefox 12.0, Internet Explorer 8.0/9.0
Windows XP Pro SP3 (x86 32-bit)	Firefox 12.0, Internet Explorer 8.0/9.0
Windows Server 2003 Standard SP2 (x86 32-bit)	Firefox 12.0, Internet Explorer 8.0/9.0
Windows Server 2008 Standard	Firefox 12.0, Internet Explorer 8.0/9.0
Windows Server 2008 R2 Standard (64-bit)	Internet Explorer 8.0, 9.0
Windows 7 Professional (x86)	Firefox 12.0
Windows 8	Firefox 12.0, Internet Explorer 8.0/9.0/10.0
Solaris 9 (SPARC only)	Firefox 12.0
Solaris 10 (SPARC only)	
Oracle Enterprise Linux 6.1 (x86 32-bit)	Firefox 12.0

For Windows systems, a minimum of 512 MB of RAM for fabrics comprising up to 15 switches, 1 GB of RAM for fabrics comprising more than 15 switches, or a DCX with a fully populated blade, and a minimum of 8 MB of video RAM are recommended.

Setting refresh frequency for Internet Explorer

Correct operation of Web Tools with Internet Explorer requires specifying the appropriate settings for browser refresh frequency and process model. Browser pages should be refreshed frequently to ensure the correct operation of Web Tools.

To set the Internet Explorer options, perform the following steps.

1. Open your web browser and select **Tools > Internet Options**.
2. Select **General > Browsing History > Settings**.
3. Choose **Every time I visit the webpage** under **Check for newer versions of stored pages** as shown in the following figure.

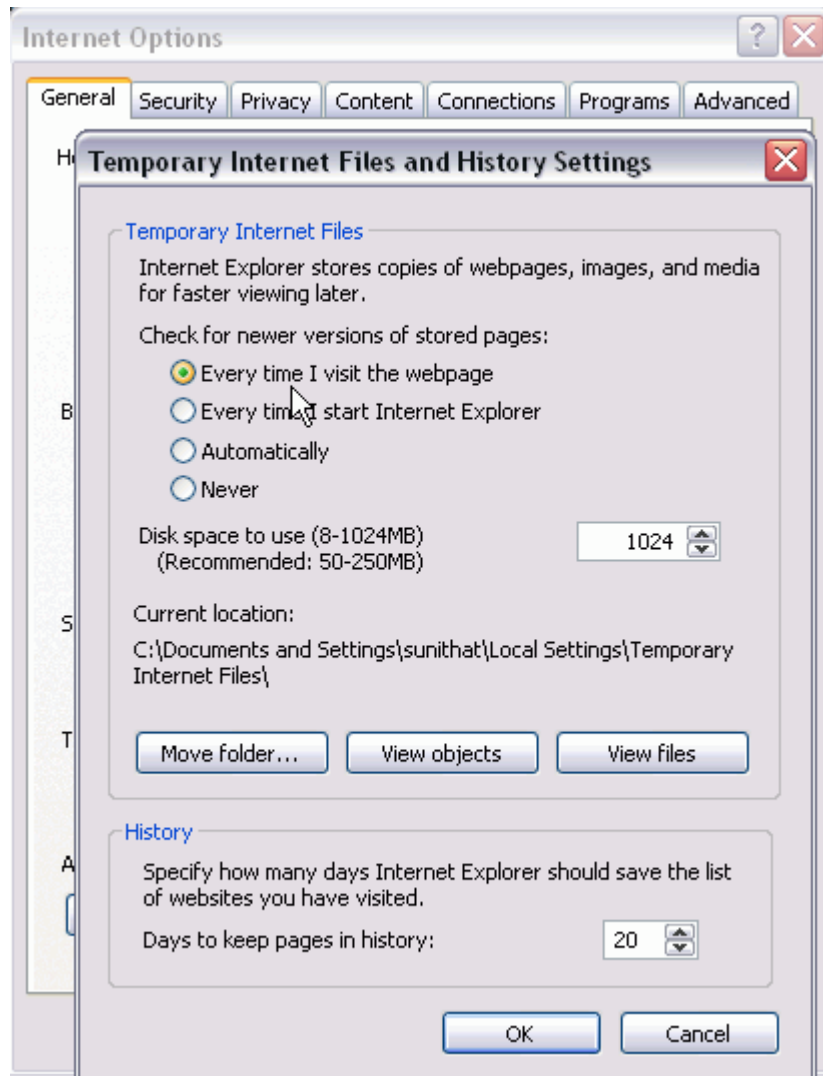
FIGURE 1 Configuring Internet Explorer

Deleting temporary Internet files used by Java applications

For Web Tools to operate correctly, you must delete the temporary Internet files used by Java applications.

To delete these files, perform the following steps.

1. From the **Control Panel**, open Java.
2. Select the **General** tab and click **Settings**.
3. Click **Delete Files** to remove the temporary files used by Java applications.
4. Click **OK** on the confirmation dialog box.

You can clear the **Trace and Log files** check box if you want to keep those files.

5. Click **OK**.
6. On the **Java Control Panel**, click **View** to review the files that are in the Java cache.

If you have deleted all the temporary files, the list is empty.

Java installation on the workstation

Java Plug-in must be installed on the workstation. If you attempt to open Web Tools without any Java Plug-in installed:

- Internet Explorer automatically prompts and downloads the proper Java Plug-in.
- Firefox downloads the most recently released Java Plug-in.

If you attempt to open Web Tools with a later version of Java Plug-in installed:

- Internet Explorer might prompt for an upgrade, depending on the existing Java Plug-in version.
- Firefox uses the existing Java Plug-in.

Installing the JRE on your Solaris or Linux client workstation

To install JRE on your Solaris or Linux client workstation, perform the following steps.

1. Locate the JRE on the Internet, at the following URL:

<http://www.oracle.com/technetwork/java/archive-139210.html>

NOTE

This URL points to a non-Brocade website and is subject to change without notice.

2. On locating the JRE link, follow the instructions to install the JRE.
3. Create a symbolic link from this location:

```
$FIREFOX/plugins/libjavaplugin_oji.so
```

To this location:

```
$JRE/plugin/$ARCH/ns600/libjavaplugin_oji.so
```

Installing patches on Solaris

To install patches on Solaris, perform the following steps.

1. Search for any required patches for your current version of the JRE at the following website:

<http://www.oracle.com/technetwork/java/javase/downloads/jre7u9-downloads-1859586.html>

NOTE

This URL points to a non-Brocade website and is subject to change without notice.

2. Follow the link to download the patch.
3. Exit the browser when you have downloaded the patch.
4. Install the patch and restart the system.

Installing the Java Plug-in on Windows

To Install the Java Plug-in on Windows, perform the following steps.

1. From the **Start** menu, select **Control Panel** and select the **Java Control Panel**.
2. Select the **About** tab.
3. Determine whether the correct Java Plug-in version is installed:
 - If the correct version is installed, Web Tools is ready to use.
 - If no Java Plug-in is installed, point the browser to a switch running Fabric OS 7.0.0 or later to install JRE 1.7.0. Web Tools guides you through the steps to download the proper Java Plug-in.
 - If an outdated version is currently installed, uninstall it, restart your computer, reopen the browser, and enter the address of a switch running Fabric OS 7.0.0 or later to install JRE 1.7.0. Web Tools guides you through the steps to download the proper Java Plug-in.

Java Plug-in configuration

If you are managing fabrics with more than 10 switches or 1000 ports, or if you are using the iSCSI Gateway module extensively, you should increase the default heap size to 256 MB to avoid out-of-memory errors.

If you are using a Mozilla family browser (Firefox, Netscape), you should set the default browser in the **Java Control Panel**.

The following procedures instruct you in increasing the default heap size in the **Java Control Panel** and in setting the default browser.

Enabling Java content in the browser

Launching Web Tools from a browser or Brocade Network Advisor is done using Java Web Start technology. This requires the local system's web browser to be able to run Java web start applications. This setting may have been turned off in the wake of recent Java zero-day vulnerabilities.

To turn on Java content in the browser, perform the following steps.

1. Launch **Java Control Panel**.
2. Click the **Security** tab and select the **Enable Java content in the browser** check box.
3. Click **Apply**.

When the **Windows User Account Control** (UAC) dialog box displays, allow permissions to make the changes.

4. Click **OK** in the Java Plug-in confirmation window.

You can now enter the IP address of the switch and launch Web Tools from a browser.

Configuring the Java Plug-in for Windows

To configure Java Plug-in for Windows, perform the following steps.

1. From the **Start** menu, select **Control Panel** > **Java**.
2. Click the **Java** tab.
3. In the **Java Applet Runtime Settings** section, click **View**.

The **Java Runtime Environment Settings** dialog box displays.

4. Double-click the **Runtime Parameters** field and enter the following information to set the minimum and maximum heap size:

```
-Xms256m -Xmx256m
```

In this example, the minimum and maximum sizes are both 256 MB.

5. Click **OK** to apply your settings and close the **Java Control Panel**.

Configuring the Java Plug-in for Mozilla family browsers

To configure Java Plug-in for Mozilla family browsers, perform the following steps.

1. From the **Start** menu, select **Control Panel**.
2. Click the **Advanced** tab and expand the **Default Java for browsers** option, as shown in the following figure.

FIGURE 2 Default Java for browsers option

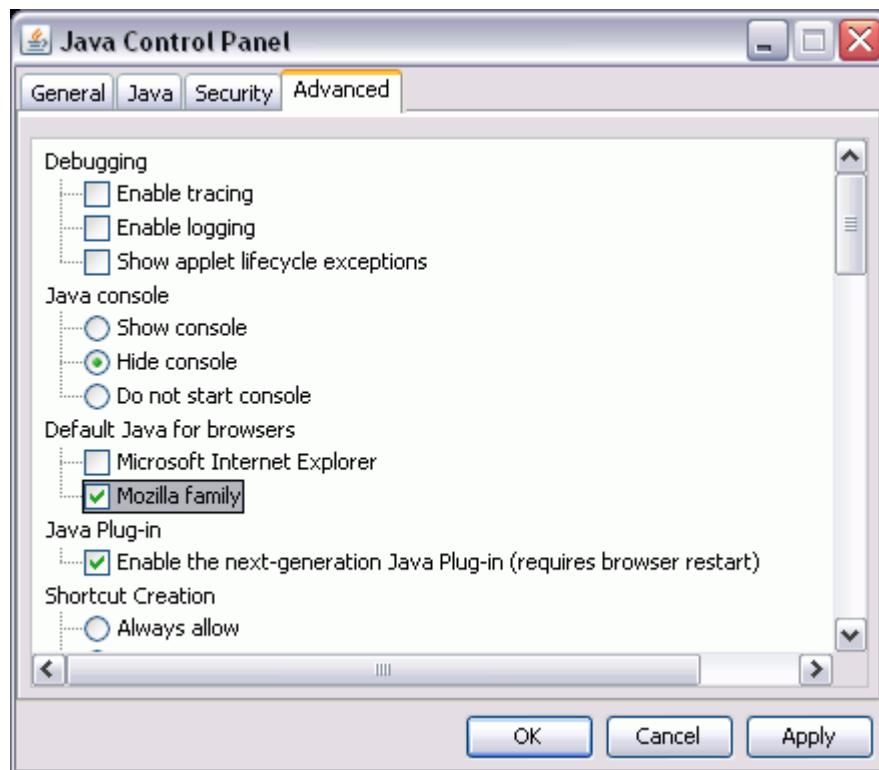

3. Select **Mozilla family** and click **Apply**.
4. Click **OK** to apply your settings and close the **Java Control Panel**.

Value line licenses

If you open Web Tools on a switch with a limited license, and if the fabric exceeds the switch limit indicated in the license, then Web Tools displays a warning message. Web Tools allows a 30-day

grace period, during which you can still monitor the switch while continuing to display warning messages periodically.

These messages warn you that your fabric size exceeds the supported switch configuration limit and tells you how long you have before Web Tools is disabled. After the 30-day grace period, you are no longer able to open Web Tools from the switch with the limited switch license.

Web Tools is part of the Fabric OS of a switch. When you open Web Tools on a switch, you can manage other switches in the fabric that have earlier or later firmware versions. It is important to note that when accessing these switches you are opening the remote switch's version of Web Tools, and the functionality available for those switches might vary.

Opening Web Tools

You can open Web Tools on any workstation with a compatible Web browser installed. For a list of Web browsers compatible with Fabric OS v7.3.0, refer to [System requirements](#) on page 23. Web Tools supports both HTTP and HTTPS.

To open Web Tools, perform the following steps.

1. Open the Web browser and enter the IP address of the device in the **Address** field, such as:

```
http://10.77.77.77
```

or

```
https://10.77.77.77
```

2. Press **Enter**.

The Web Tools login dialog box displays. Refer to [Logging in](#) on page 29 for more information.

NOTE

If you are using Firefox, the browser window is left open. You can close it anytime after the login dialog box displays. If you are using Internet Explorer, the browser window automatically closes when the login dialog box displays.

NOTE

If you have installed EZSwitchSetup on your workstation, the EZSwitchSetup Switch Manager displays the first time you access the device. EZSwitchSetup provides an easy-to-use wizard interface that may be used to simplify the initial setup procedure for smaller switches. Refer to the *EZSwitchSetup Administrator's Guide* for information about the EZSwitchSetup interface. If you want to use Web Tools instead of EZSwitchSetup, click **Advanced Management** in the lower-left corner of the window to open the Web Tools interface. This guide describes only the Web Tools interface.

Logging in

When you use Web Tools, you must log in before you can view or modify any switch information. This section describes the login process.

Prior to displaying the login window, Web Tools displays a security banner (if one is configured for your switch), that you must accept before logging in. The security banner displays every time you access the switch.

When you are presented with the login window, you must provide a user name and a password. Your home Admin Domain is automatically selected. You can select to log in to an Admin Domain other than your home domain.

NOTE

You must log in before you can view Switch Explorer (shown in [Figure 4](#) on page 39).

Use this procedure to log in to the Admin Domain.

1. Click **Run** on the signed certificate applet.

A warning dialog box may display. If you select the check box **Always trust content from this publisher**, the warning dialog box is not displayed when you open Web Tools again.

2. Click **OK** in the security banner window, if one displays.
3. In the login dialog box, enter your user name and password.

If your current password has expired, you must provide a new password and confirm the new password.

Logging in to a Virtual Fabric

If you are logging in to a platform that is capable of supporting Virtual Fabrics, the login dialog box provides the option of logging in to a Virtual Fabric. The following platforms support Virtual Fabrics:

- Brocade 7800
- Brocade 7840
- Brocade DCX and DCX-4S
- Brocade VA-40FC
- Brocade 6510
- Brocade 6520
- Brocade DCX 8510-8 and DCX 8510-4
- Brocade 5300
- Brocade 5100
- Brocade 5432
- Brocade 6548

To log in to a Virtual Fabric, perform the following steps.

1. Select **Options** to display the Virtual Fabric options.

You are given a choice between **Home Logical Fabric** and **User Specified Logical Fabric** as shown in the following figure. **Home Logical Fabric** is the default.

FIGURE 3 Virtual Fabric login option

2. Log in to a logical fabric.

- To log in to the home logical fabric, select **Home Logical Fabric** and click **OK**.
- To log in to a logical fabric other than the home logical fabric, select **User Specified Logical Fabric**, enter the fabric ID number or the context name, and click **OK**.

On providing the context name, a dialog box displays with the available list of VF ID-Context Name (role of the context). You can select the role from the list and log in.

Switching between Virtual Fabrics

To switch between one Virtual Fabric to another, perform the following steps.

1. Log in to Web Tools using the **User Specified Logical Fabric** option.

You can enter the context name to log in.

2. Select the context name you want to access from the **Logical Switch** list.

The base switch has **Base** appended in the context name.

3. Click **Yes** on the **Switch Virtual Fabric Context** confirmation dialog box.

4. Repeat step 2 and step 3 to switch to another Virtual Fabric.

Logging in to an Admin Domain

If you are logging in to a platform that is capable of supporting Admin Domains, the login dialog box displays. You do not have an **Admin Domain** option if the Access Gateway mode is enabled. Admin Domains and Virtual Fabrics are mutually exclusive.

1. Select **Options** to select an Admin Domain other than your default home domain.

You are given a choice of **Home Domain** (the default) or **User Specified Domain**.

2. Log in to an Admin Domain.

- To log in to the home domain, select **Home Domain** and click **OK**.
- To log in to an Admin Domain other than the home domain, select **User Specified Domain**, enter the Admin Domain name or number, and click **OK**.

If the user name or password is incorrect, a dialog box displays indicating an authentication failure.

If you entered valid credentials, but specified an invalid Admin Domain, a dialog box displays from which you can select a valid Admin Domain or click **Cancel** to log in to your home domain.

Logging out

You can end a Web Tools session either by selecting **Manage > Exit**, or by closing the **Switch Explorer** window.

You might be logged out of a session involuntarily, without explicitly selecting the **Manage > Exit**, under the following conditions:

- A physical fabric administrator changes the contents of your currently selected Admin Domain.
- Your currently selected Admin Domain is removed or invalidated.
- Your currently selected Admin Domain is removed from your **Admin Domain** list.
- You initiate a firmware download from the Web Tools **Switch Administration** window. In this case, you are logged out a few minutes later when the switch restarts.
- Your session times out.

Role-Based Access Control

Role-Based Access Control (RBAC) defines the capabilities that a user account has based on the assigned role. For each role, there is a set of predefined permissions on the jobs and tasks that can be performed on a fabric and its associated fabric elements.

When you log in to a switch, your user account is associated with a predefined role. The role determines the level of access you have on that switch and in the fabric. The following table describes these roles.

For information about creating unique user account roles, refer to [User-defined accounts](#) on page 197.

TABLE 5 Predefined Web Tools roles

Role	Description
admin	You have full access to all of the Web Tools features.
operator	You can perform any actions on the switch that do not affect the stored configuration.
securityadmin	You can perform actions that do not affect the stored configuration.
switchadmin	You can perform all actions on the switch, except the following: <ul style="list-style-type: none"> • You cannot modify zoning configurations. • You cannot create new accounts. • You cannot view or change account information for any accounts. You can only view your own account and change your account password.

TABLE 5 Predefined Web Tools roles (Continued)

Role	Description
zoneadmin	You can only create and modify zones.
fabricadmin	You can do everything the Admin role can do except create new users.
basicswitchadmin	You have a subset of Admin level access.
user	You have nonadministrative access and can perform tasks such as monitoring system activity.

Session management

A Web Tools session is the connection between the Web Tools client and its managed switch. A session is established when you log in to a switch through Web Tools. When you close Switch Explorer, Web Tools ends the session.

A session remains in effect until one of the following happens:

- You exit
- You close the **Switch Explorer** window
- The session ends due to inactivity (time out)

A session automatically ends if no information was sent to the switch for more than two hours. Because user keystrokes are not sent to the switch until you apply or save the information, it is possible for your session to end while you are entering information in the interface. For example, entering a zoning scheme in the Zoning module does not require you to send information to the switch until you save the scheme.

Web Tools does not display a warning when the session is about to time out. If your session ends due to inactivity, all Web Tools windows become invalid and you must restart Web Tools and log in again.

Web Tools enables sessions to both secure and nonsecure switches.

Access rights for your session are determined by your role-based access rights and by the contents of your selected Admin Domain. After you log in, you can change to a different Admin Domain at any time. However, you cannot change your role-based permissions.

Ending a Web Tools session

To end a Web Tools session, perform one of the following actions:

- Select **Manage > Exit**.
- Click the X in the upper-right corner of the **Switch Explorer** window to close it.
- Close all open Web Tools windows.

Web Tools system logs

Web Tools uses the log4j framework to write the logs into a file.

When you launch Web Tools for the first time, it automatically creates the following directories. These directories are created under Web Tools directory if they are not available:

- A *<Web Tools>* directory under the user home directory.
- The Web Tools Switch Support Save directory with the name format *<Core Switch Name-Switch IP Address-Switch WWN>*.

The Web Tools Switch Support Save directory contains the following files:

- Log4j.xml
- WebTools.log
- SwitchInfo.txt

The SwitchInfo.txt file contains the following basic switch information:

- Switch name
- Fabric OS version
- Switch type
- Ethernet IPv4
- Ethernet IPv4 subnet mask
- Ethernet IPv4 gateway

The maximum size of the webtools.log file is 5 MB. It is rolled into a new file when the 5 MB file size limit is exceeded. A backup file named webtools1.log is automatically created. Web Tools maintains only one webtools.log backup file at a time.

The Web Tools debug dialog box can be used to enable the debug state and level for a module at runtime.

If you are familiar with XML scripting, you can edit the configuration file (log4j.xml) to collect the data at startup. If you edit the configuration file, Web Tools need to be restarted. Contact your switch support supplier for assistance.

SupportSave logs

Beginning with Fabric OS v7.1.0, Web Tools allows you to collect the following Web Tools-related SupportSave data:

NOTE

Web Tools SupportSave collects logs for troubleshooting Web Tools. To collect switch logs, use the **SupportSave** command through the Fabric OS CLI or the Technical Support feature in Brocade Network Advisor.

- HTML files
- CAL files
- Web Tools logs folder

To collect SupportSave logs, perform the following steps.

1. Click **Tools** > **SupportSave**.

The **SupportSave** dialog box displays.

2. Click **Browse** to select the location where the SupportSave output must be saved.

The default path for Windows is C:\Documents and Settings\<<user>>\Webtools\<log file>.

The default path for Linux is /root/WebTools/<switch log file>.

3. Click **Capture** to start collecting the SupportSave logs.

A zipped-up SupportSave folder is saved in the defined location. SupportSave zip file name format is "WT-SS-switchIP-FID-dd-mm-yy-hh-mm-ss". The SupportSave file name will show the VF ID if VF is enabled on the switch.

NOTE

SupportSave collection is terminated if the time exceeds 20 minutes.

Requirements for IPv6 support

The following list provides requirements for Web Tools IPv6 support:

- In a pure IPv6 environment, you must configure your DNS maps to the IPv6 address of the switch.
- The switch name is required to match the DNS name that is mapped to the IPv6 address.
- If both IPv4 and IPv6 addresses are configured, Web Tools can be launched using any configured IP address.

Using the Web Tools Interface

- [Viewing Switch Explorer](#).....37
- [Displaying tool tips](#)..... 45
- [Right-click options](#)..... 45
- [Refresh rates](#).....46
- [Displaying switches in the fabric](#)..... 47
- [Recommendations for working with Web Tools](#)..... 47
- [Opening a Telnet or SSH client window](#).....48
- [Collecting logs for troubleshooting](#)..... 48

Viewing Switch Explorer

The first thing you see when you log in to a switch with Web Tools is Switch Explorer, shown in the following figure. Switch Explorer is divided into tabs and areas that provide access to, and information, about the switch and fabric. The Switch Explorer areas are:

- Three tabs - **Switch View**, **Port Admin**, and **Name Server**.

If Access Gateway is enabled, the **Access Gateway Devices** tab displays instead of **Name Server**. For more information, refer to [Using the Access Gateway](#) on page 175.

The **Fabric Tree** under **Switch View** displays a list of all the switches in the fabric.

- The menu bar, at the top of the window, provides access to the following tasks:
 - Viewing tasks, such as the switch view, port administration, and name server.
 - Configuration tasks, such as switch administration, zone administration, fabric watch, and switch status policy.

NOTE

You can manage basic zoning and Traffic Isolation zoning using Web Tools and Web Tools with the Enhanced Group Management (EGM) license. To perform clone operations for zoning, the EGM license must be installed on the switch; otherwise, access to this feature is denied and an error message displays. You must use Brocade Network Advisor to print the zone database summary configuration and to analyze zone configurations. For more information on zoning management, refer to [Zone configuration and zoning database management](#) on page 151.

- Monitoring tasks, such as performance monitoring, system monitoring, and viewing the power, temperature, or fan status.

NOTE

To perform monitoring tasks such as performance monitoring, the EGM license must be installed on the switch; otherwise, access to this feature is denied and an error message displays.

- Reporting tasks, such as viewing the status of a switch.
- Tools tasks, such as opening the Telnet or SSH client window, beaconing a switch or chassis, and access to SupportSave.
- The buttons below the menu bar provide access to switch information: status, temperature, power, and fan data.

Although clicking a button can open a separate dialog box or window displaying the management tasks, all access control is established when you first log in to the switch.

Buttons in Switch Explorer are unavailable for two reasons: because your account does not have sufficient privileges to access this feature, or your currently selected Admin Domain does not meet some condition to access the feature.

- The **Switch View** displays an interactive graphic of the switch.
- The **Switch Events** and **Switch Information** tabs allow you to view event information and switch information, including connectivity, port, zone and other information.
- An indicator bar in the lower-right corner of every module window contains the Admin Domain you are currently viewing, the current user name logged in to the switch, and the role associated with that user account.
- The small right arrow near the **Switch Event** tab displays the switch. When you exit Web Tools, it remembers the last window settings the next time you log in to the application. If you display the switch, the next time you log in to Web Tools, by default the **Switch View** displays.
- Web Tools displays host time and switch time. The timestamp displayed in the **Last polling refresh time** field in the lower-left corner of the window is the host time, in which the Web Tools is launched. All other timestamp displayed in the application is the switch time. The following are the features that display the host time.
 - Port Admin tab
 - Switch View tab
 - Name Server tab
 - FCR dialog
 - Fabric Watch dialog
 - System Monitoring dialog
 - Netstat Performance dialog in Switch Admin tab

The EGM license is required only for 8 Gbps platforms, such as the following:

- Brocade Encryption Switch
- Brocade 300, 5300, 5100, and 5432 switches
- Brocade VA-40FC
- Brocade 7800

For non-8 Gbps platforms, all functionalities are available without the EGM license.

FIGURE 4 Switch Explorer

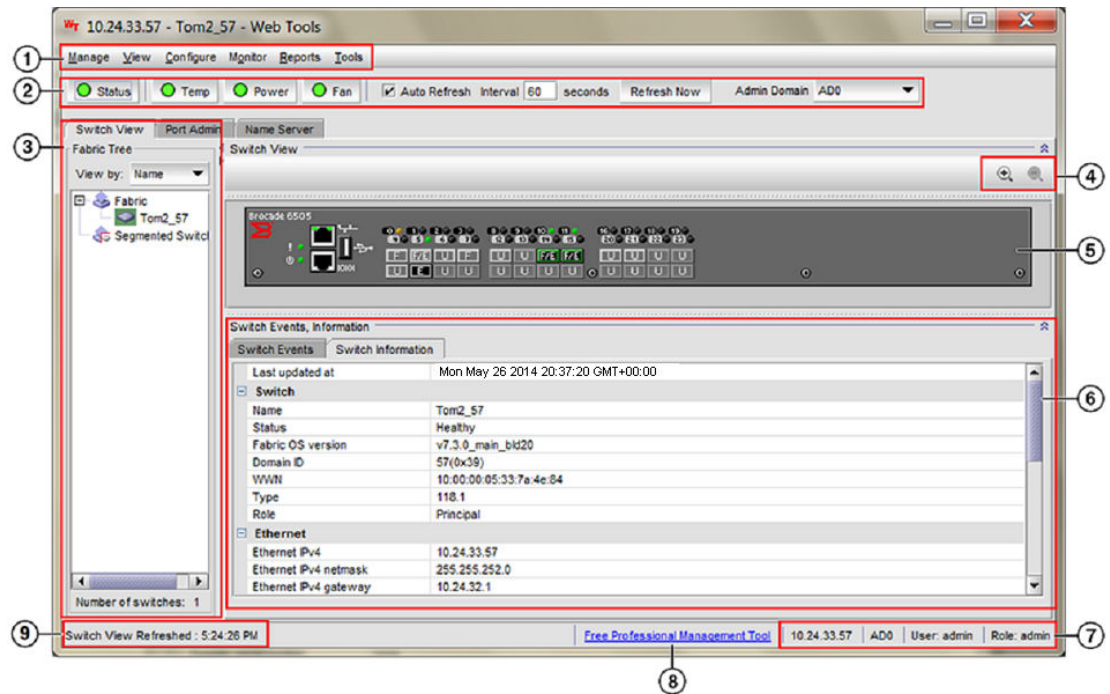

1. Menu bar
2. Switch View buttons
3. Tabs and Fabric Tree
4. Zoom in and Zoom out buttons
5. Switch View
6. Switch Events and Switch Information
7. Indicator bar
8. Professional Management Tool offering
9. Last polling refresh time - The host time in which Web Tools is launched

Persisting GUI preferences

Web Tools persists your GUI preferences across sessions for Switch Explorer, and the **Port Admin**, **Switch Admin**, **Name Server**, and **Zone Admin** dialog boxes on all browser platforms. Persistence is performed on a per-host basis.

If you launch Web Tools from Brocade Network Advisor (BNA), all of the Web Tools GUI persistence data for each user name is stored in the BNA database.

The **Port Admin** GUI preferences that persist are:

- Basic or Advance mode
- Last selected tab by the user
- Table column sorting
- Table column positions

The **Switch Admin** GUI preferences that persist are:

- Basic or Advance mode
- Last selected tab

- Table column sorting
- Table column positions

The Switch Explorer GUI preferences that persist are:

- Last selected tab

The **Name Server** GUI preferences that persist are:

- Table column sorting
- Table column positions

The **Zone Admin** GUI preferences that persist are:

- Basic Zones
- Traffic Isolation Zones
- Last selected tab
- Table column sorting
- Table column positions

Tabs

Switch Explorer provides access to the following three tabs:

- **Switch View**
- **Port Admin**
- **Name Server** --This feature is available with Web Tools and Web Tools with the EGM license. Name Server information is collected from the selected switch. Refer to "[Displaying the Name Server entries](#)" on page 53 for more information.

Fabric Tree

Fabric Tree under **Switch View** displays all switches in the fabric, even those that do not have a Web Tools license and that are not owned by your selected Admin Domain. Switches that are not owned by the Admin Domain are shown in the **Fabric Tree** with switch status. **Fabric Tree** does not display switches segmented before you opened Web Tools.

Only two types of switch icons display in **Fabric Tree**; one for a pizza box and one for a chassis. No platform-based icons are supported.

Use the menu at the top of the **Fabric Tree** area to view switches in the **Fabric Tree** by switch name, IP address, or WWN. You can rest the pointer over a switch to display the IP address, current status, and other details of the switch. To manually refresh the status of a switch within the fabric, right-click the switch in the **Fabric Tree** and select **Refresh**.

Although **Fabric Tree** displays all the switches in the fabric, you can manage switches that support Fabric OS v6.1 and later versions because it does not require a Web Tools license. If a switch is launched from **Fabric Tree**, preference will be given to IPv4, even though both IPv4 and IPv6 are configured for that particular switch.

The versions earlier than Fabric OS v6.1 require a Web Tools license and, if applicable, an EGM license installed. Other switches must be managed through the Fabric OS command line interface (CLI), another management application, or by using Brocade Network Advisor.

Changing the Admin Domain context

The **Admin Domain** field displays the currently selected Admin Domain and allows you to change to a different one. The ability to change Admin Domain context requires that the EGM license is enabled on the switch. Otherwise, an error message displays.

If you are logged in to Web Tools without the EGM license, you must log in again using a specific Admin Domain.

After you log in, all Admin Domains assigned to you are available in the menu. For most administrative tasks, you must be in either AD0 or the physical fabric.

When changing the Admin Domain context, the option for selecting AD from the list is not available if the EGM license is not present.

To change the Admin Domain context, perform the following steps.

1. Select a domain from the **Admin Domain** menu.
2. Click **OK** in the confirmation window.

Switch Explorer refreshes to display the new Admin Domain context. You can monitor the progress using the progress bar.

The system displays a list of all open windows. You can choose to change the Admin Domain, which closes all the open windows, or cancel the action and return to Switch Explorer.

NOTE

The **Telnet** window and the **Fabric Details** are not AD-filtered and do not need to be closed.

Switch View buttons

The **Switch View** buttons let you access the following switch information:

- **Status** --Click the button to view the status of the switch.
- **Temp** --Click the button to view temperature monitors.
- **Power** --Click the button to view power supply information.
- **Fan** --Click the button to view the status of the switch fans.

NOTE

For all status displays based on errors per time interval, any errors cause the status to show faulty until the entire sample interval has passed.

Switch View

You can click the small right arrow towards the left of the **Switch Event** tab to display the **Switch View**. The **Switch View** displays a graphical representation of the switch, including a real-time view of switch and port status. Refer to [Figure 4](#) on page 39.

NOTE

Blades are graphically represented in the Web Tools GUI. They are vertical in the DCX, and horizontal in the DCX-4S.

The default **Switch View** display refresh rate is 60 seconds. However, the initial display of Switch Explorer may take from 30 to 60 seconds after the switch is booted. Refresh rates are fabric-size dependent. The auto-refresh interval may not be less than 45 seconds. However, the refresh rate varies depending on the activity in the fabric and on the host system you are using. The larger the fabric, the longer it takes to poll the fabric and refresh the view. F_Port and L_Port connection changes refresh immediately.

Port representations

The ports in the **Switch View** show the port type. Borders around the accessible ports indicate that SFP modules are present. A colored border indicates the status of the port; for example, a green border indicates that the port is connected and traffic is flowing. Ports that are not accessible do not display the port type and do not have borders.

When you pause the pointer on a port, a yellow color toggling effect is available to identify the selected port.

The port LEDs in the **Switch View** match the LEDs on the physical switch. However, the blink rate of the LEDs in the **Switch View** does not necessarily match the blink rate of the LEDs on the physical switch. Refer to [Port LED interpretation](#) on page 166 for more information.

Right-click a port in the **Switch View** to get a menu that opens the **Port Admin** tab, allowing you to view detailed information about the port. From **Port Admin**, you can access information on all other ports. Refer to [Managing Ports](#) on page 95 for more information.

NOTE

For detailed information on ISL Trunking, F_Port Trunking, and long distance, you must install the EGM license on the switch; otherwise access to these features is denied and an error message is displayed.

E_Ports are visible in all domains. For the Brocade DCX, the Port Admin view is launched for ICL ports.

USB port representation

For switches with USB ports, the **USB Storage Management** view is launched for USB ports as shown in the following figure.

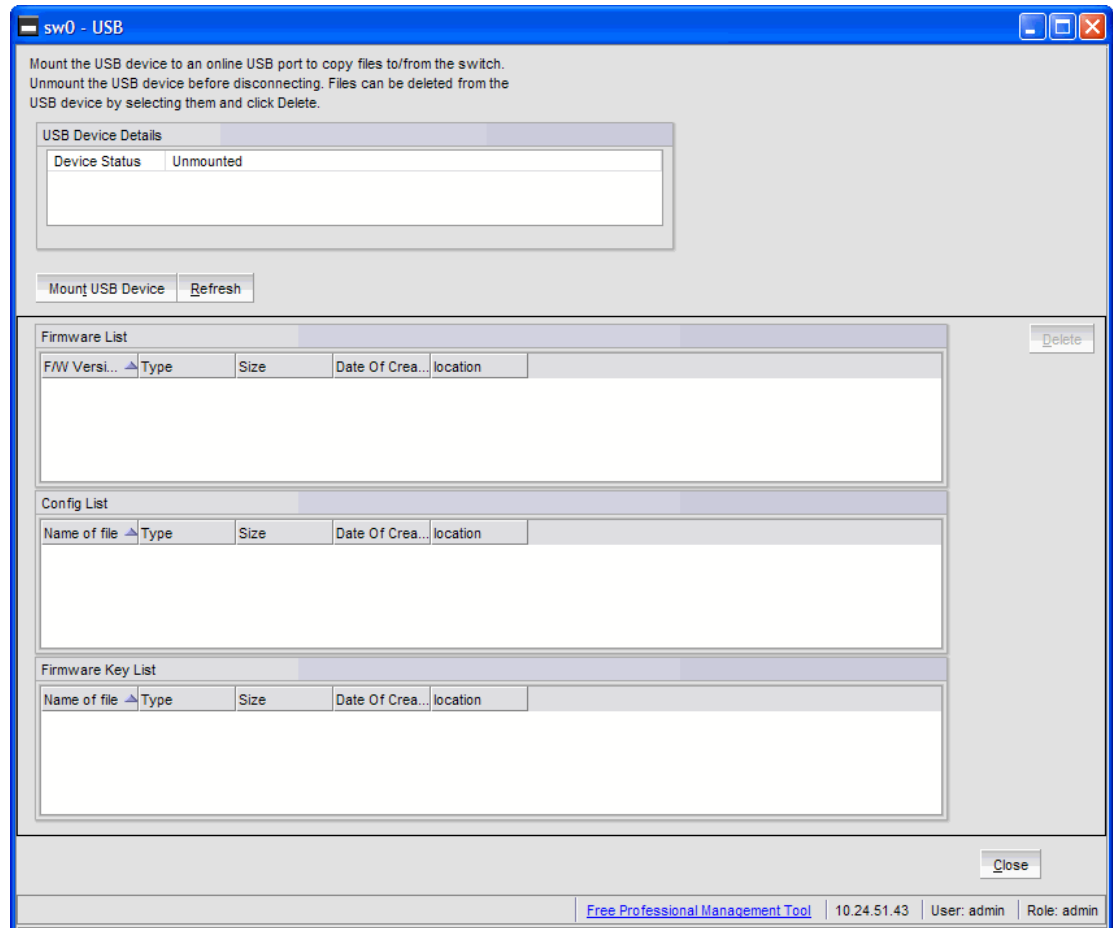
FIGURE 5 USB port storage management**NOTE**

Click the USB port on the Switch View to launch the **USB Storage Management** window.

Zoom in and zoom out

You can use the zoom buttons () above the graphical Switch View to magnify the hardware image. Click the zoom in button (+) to see an enlarged view of the switch and click the zoom out button (-) to see the default view of the switch. You can pause the pointer over the zoom in button (+) and the zoom out button (-) to view the tool tip.

Switch Events and Switch Information

Switch Events and **Switch Information** display as tab forms under **Switch View**. The **Switch Information** tab is polled every 60 seconds and the **Switch Events** tab is polled every 15 seconds. Both the tabs are polled based on the switch time.

NOTE

You can click the column head to sort the events by a particular column, and drag the column divider to resize a column. You can also right-click a column heading to resize one or all columns, sort the information in ascending or descending order, or select which columns are displayed.

The **Switch Information** tab displays information about the following items:

- **Last updated at:** Displays the switch time.
- **Switch**
 - **Name:** Name of the switch.
 - **Status:** Status of the switch.
 - **Fabric OS Version:** Fabric OS version of the switch.
 - **Domain ID:** Domain ID of the switch.
 - **WWN:** World Wide Name of the switch.
 - **Type:** Type of the switch.
 - **Role:** Role of the switch.

The following information is specific to Virtual Fabrics:

- **Base Switch:** Indicates whether the logical switch can act as a base switch.
- **Default Switch:** Indicates whether the logical switch is the default logical switch.
- **Allow XISL Use:** Indicates whether the logical switch is allowed to connect to other logical switches using an extended inter-switch link (XISL).
- **Ethernet**
 - **Ethernet IPv4:** Ethernet IPv4 address of the switch.
 - **Ethernet IPv4 netmask:** Ethernet IPv4 subnet mask address of the switch.
 - **Ethernet IPv4 gateway:** Ethernet IPv4 gateway address of the switch.
 - **Ethernet IPv6 :** Ethernet IPv6 address of the switch.
- **FC**
 - **IPFC IPv4:** Fiber Channel IPv4 address.
 - **IPFC IPv4 net mask:** Fiber Channel IPv4 subnet mask address.
- **Model Type**
 - **Brocade DCX 8510-8 and DCX 8510-4:** Model type value is 1.
 - **Brocade DCX and DCX-4S:** Model type is not supported.
- **Zone**
 - **Effective Configuration:** Indicates whether zone configuration is enabled or not.
- **Other**
 - **Manufacturer serial number:** Displays the serial number of the manufacturer.
 - **Supplier serial number:** Displays the serial number of the supplier.
 - **License ID:** Displays the license ID.
- **RNID**
 - **Type:** Type of the switch.
 - **Model:** Model of the switch.
 - **Tag:** Tag of the switch.
 - **Sequence number:** Sequence number of the switch.
 - **Insistent Domain ID Mode:** Current status of the Insistent Domain ID mode of the switch.
 - **Manufacturer:** Manufacturer of the switch.
 - **Manufacturer Plant:** Plant where the switch was manufactured.

For more information, refer to [Displaying switch information](#) on page 161.

Free Professional Management tool

You can use the Professional Management tool with Web Tools to view connectivity for each fabric, to back up and restore last-known configurations, and more. You can also use it with the Enhanced Group Management (EGM) license to manage groups of switches, download firmware, manage security settings, and deploy configurations across groups of switches. Contact your preferred storage supplier to get a complimentary copy of the Professional Management tool.

Launch the install wizard for the free Professional Management tool through the link located at the bottom of the **Switch Explorer** window.

Displaying tool tips

When you pause the pointer over a Web Tools button, the system displays a brief description of the button. If you pause the pointer over most components, the system displays tool tip information about the component.

In the **Fabric Tree**, you can pause the pointer over a switch to view its type, subtype, name, Ethernet IPv4 and IPv6 addresses, IPFC, and status of the switch.

In **Switch View**, you can pause the pointer over a blade to view the blade ID and its status. It is easier to use the top of the blade to display the tool tip so that you do not inadvertently display the port tool tips. You can select a port and pause the pointer over the **Zoom In** and **Zoom Out** buttons to see an enlarged view or the default view of the switch. Firmware versions and IP addressing are displayed for CP blades.

When you pause the pointer over a port, you can view the:

- Port name
- Port ID
- Port beacon
- Port number
- Port index
- Port type (E_Port, F_Port, L_Port, D_Port, EX_Port, GigE port, or U_Port)
- Port status (online or offline)
- Port state (in-sync, no_sync, no light, or no module)

Right-click options

You can right-click a port to quickly perform some basic port administration tasks, as shown in the following figure.

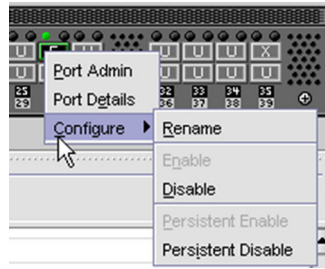
FIGURE 6 Right-click menu for ports (from Switch Explorer)

The tasks are:

- The **Port Admin** option displays the **Port Admin** tab.
- The **Port Details** option displays read-only information about a port, without opening the **Port Admin** tab. You can right-click on the table content to export or copy the information from the **Port Details** window.
- The **Configure** option provides another menu of options to allow you to rename, enable, and disable ports, and to set persistent enable or disable without opening the **Port Admin** tab.

Refresh rates

The refresh, or polling, rates listed in this section and throughout the book indicate the time between the end of one polling period and the start of the next, and not how often the screen is refreshed. A refresh rate of 60 seconds does not ensure that a refresh occurs every 60 seconds. It ensures that the time between each refresh activity is no more than 60 seconds.

Auto-refresh intervals might not be exactly 60 seconds. The refresh rate varies depending on the activity in the fabric and on the host system you are using. Following are some variables you should consider when refreshing the fabric:

- **Refresh Now** button is disabled for 6-8 seconds on every click.
- Retrieval time increases when you are in a large fabric because there is more data to retrieve from the switches.
- Processor speed of the system you are using may slow down the refresh rate.
- OS-Job Scheduling if you are using a host system in the data center impacts the refresh rate.
- JVM-Performance can contribute to causing interval differences between what is on-screen and how long it is actually taking.

For these reasons, the time displayed in the port statistics tab might not be refreshed as expected. The counter time indicates only that "this statistics data is retrieved from the switch in this time period." To ensure the correct information, the time field is updated along with the port statistics data after every refresh.

The refresh rates are different for each module. The following table lists polling rates by module. Though these rates are sample rates, they correctly illustrate variance in the refresh rates throughout Web Tools.

TABLE 6 Polling rates

Module	Polling rate
Name Server	User-defined; 45 sec minimum

TABLE 6 Polling rates (Continued)

Module	Polling rate
Zoning Database	60 sec
Fabric Watch	45 sec
Performance Monitor (This feature requires the EGM license.)	30 sec
Port Management	User-defined; 45 sec minimum
FC Routing	45-90 sec, depending on network traffic

Displaying switches in the fabric

If your fabric has more than one switch, you can open Web Tools from one switch and then access other switches. You can also launch Web Tools from the Brocade Network Advisor client as Element Manager. This lets you manage Web Tool requests where the fabric is in a private network.

Launch Web Tools from Brocade Network Advisor if you need to access the fabric from a host that is not in the same network and does not have direct access to the fabric.

NOTE

If you open switches, running Fabric OS v4.4.x or later, from a **Fabric Tree** displayed for a version earlier than a v4.4.x switch, some of the features might be disabled.

To display switches in the fabric, perform the following steps.

1. Open Web Tools as described in ["Opening Web Tools" on page 10](#) and log in to the switch.
2. If the **Fabric Tree** is not expanded, click the plus sign (+) in the **Fabric Tree** to view all the switches in the fabric.
3. Click a switch in the **Fabric Tree**.

A separate browser dialog box displays the selected switch.

The graphic of the selected switch displays in **Switch View**. Additional switch information displays in the **Switch Events** and **Switch Information** tabs.

Recommendations for working with Web Tools

Brocades makes the following recommendations for working with Web Tools:

- If you receive an error when saving changes in the **Switch Administration** window, note the error messages, refresh the window, and make your changes again. Do not continue making changes without refreshing the window and determining which changes were saved correctly.
- In a fabric containing switches and directors running different versions of firmware, use the switches or directors with the latest firmware versions to control the fabric.
- If switches are accessed simultaneously from different connections (for example, Web Tools, CLI, and API), changes from one connection might not be updated to the other, and some modifications

might be lost. Make sure that, when you connect with simultaneous multiple connections, you do not overwrite the work of another connection.

- Several tasks in Web Tools make fabric-level changes, such as the tasks in **Zone Administration**. When executing fabric-level configuration tasks, wait until you have received confirmation that the changes are implemented before executing any subsequent tasks. For a large fabric, this can take several minutes.
- Some data collection and processing operations in the iSCSI Gateway module might take a long time to complete, especially in large fabrics or fabrics with large numbers of defined Discovery Domains and Discovery Domain Sets. In most cases, progress bars are provided. Allow the application a sufficient amount of time (30-40 seconds) to collect and display data before taking any action or assuming the application is "hanging."
- A maximum of five simultaneous HTTP sessions to any one switch is recommended. An HTTP session is considered a Brocade Network Advisor or Web Tools connection to the switch.

Opening a Telnet or SSH client window

When you open a Telnet or SSH client window, it connects to the IP interface of the switch. You cannot connect to a CP blade on a director switch through a Telnet or SSH client window opened from Web Tools, even when the blade has an IP address and supports Telnet sessions. Refer to the *Fabric OS Command Reference* for information about the Telnet commands.

NOTE

Internet Explorer 10.0/11.0 default settings disable Telnet functionality. If you are using Internet Explorer 10.0/11.0, you must make the appropriate changes in the registry to open the Telnet window.

To open a Telnet or SSH client window, perform the following steps.

1. Select a switch in **Fabric Tree**.

You are prompted to log in. The selected switch displays in **Switch View**.

2. Select **Telnet/SSH Client** under **Tools** menu. The **Preference Dialog** dialog box displays.
3. Select the client by clicking **Telnet** or **SSH**.
4. Enter the Telnet or SSH path, as defined for your implementation.

To avoid the need to remember and enter in the path, you can store the path on your PC and browse to the location. Clicking the button to the right of the field initiates the browse capability.

5. Click **OK**.

The Telnet or SSH window displays.

6. Enter your user credentials at the login prompt.
7. To close the session, enter **exit** at the prompt and press the **Enter** key.

Collecting logs for troubleshooting

If you encounter problems using the Web Tools interface, collect Java logs for use in troubleshooting. From Microsoft Windows, perform this procedure.

1. Open the **Control Panel** and select **Java**.
2. Click the **Advanced** tab.

3. Expand the **Java console**.
4. Select **Show console**.
5. Restart Web Tools.

The Java console displays, along with the Web Tools opening page.

6. Perform the Web Tools operation that caused the problem.
7. Collect the logs shown on the Java console.
8. If you no longer want to see the Java console when you start Web Tools, go back to the **Control Panel**, repeat steps 1 and 2, and then deselect **Show console**.

Managing Fabrics and Switches

- Fabric and switch management overview..... 51
- Configuring IP and subnet mask information..... 53
- Configuring Netstat Auto Refresh..... 54
- Configuring a syslog IP address..... 54
- Removing a syslog IP address..... 55
- Configuring IP filtering..... 55
- Blade management..... 56
- Switch configuration..... 58
- Switch restart..... 61
- System configuration parameters..... 62
- Licensed feature management..... 67
- High Availability overview..... 69
- Event monitoring..... 71
- Displaying the Name Server entries..... 74
- Physically locating a switch using beaconing..... 75
- Locating logical switches using chassis beaconing..... 75
- Virtual Fabrics overview..... 76

Fabric and switch management overview

Most of the management tasks described in this chapter are accessed through the **Switch Administration** window. Information in the **Switch Administration** window is retrieved from the selected switch, as shown in the following figure.

If the switch is not a member of the selected Admin Domain, most tabs in the **Switch Administration** window display in read-only mode, regardless of your permission level. The **User** tab is editable because most of its information does not require switch membership in the current Admin Domain.

FIGURE 7 Switch Administration window, Switch tab, Basic mode

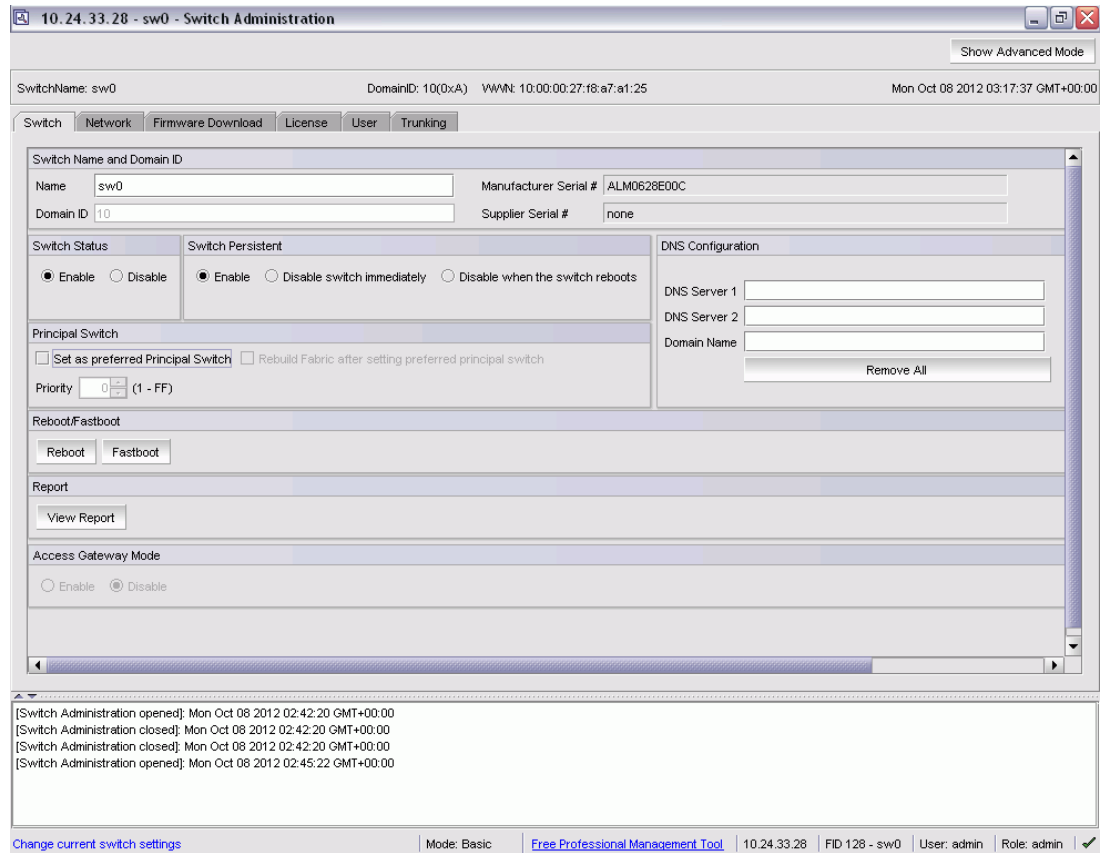

With the exception of switch time, information displayed in the **Switch Administration** window is not updated automatically by Web Tools. To update the information displayed in the **Switch Administration** window, click the **Refresh** button.

ATTENTION

Most changes you make in the **Switch Administration** window are buffered, and are *not* applied to the switch until you save the changes. If you close the **Switch Administration** window without saving your changes, your changes are lost. To save the buffered changes you make in the **Switch Administration** window to the switch, click **Apply** before closing the module or before switching to another tab. The **License** tab, **Firmware Download** tab, and the **Security Policies** tab are exceptions. The changes you make on these tabs take effect immediately and there is no **Apply** button. There is an **Apply** button in all the subtabs of security policies except ACL.

You can also use Telnet commands to perform management tasks. Refer to "[Opening a Telnet or SSH client window](#)" on page 28 for information on how to launch a Telnet window using Web Tools.

Opening the Switch Administration window

Most of the management procedures in this chapter are performed from the **Switch Administration** window.

To open the **Switch Administration** window, perform the following steps.

1. Click **Configure** > **Switch Admin**.

The **Switch Administration** window displays in basic mode, as shown in [Figure 7](#) on page 52. The basic mode displays the "basic" tabs and options.

2. Click **Show Advanced Mode** to see all the available tabs and options, as shown in the following figure.

FIGURE 8 Switch Administration window, Switch tab, Advanced mode

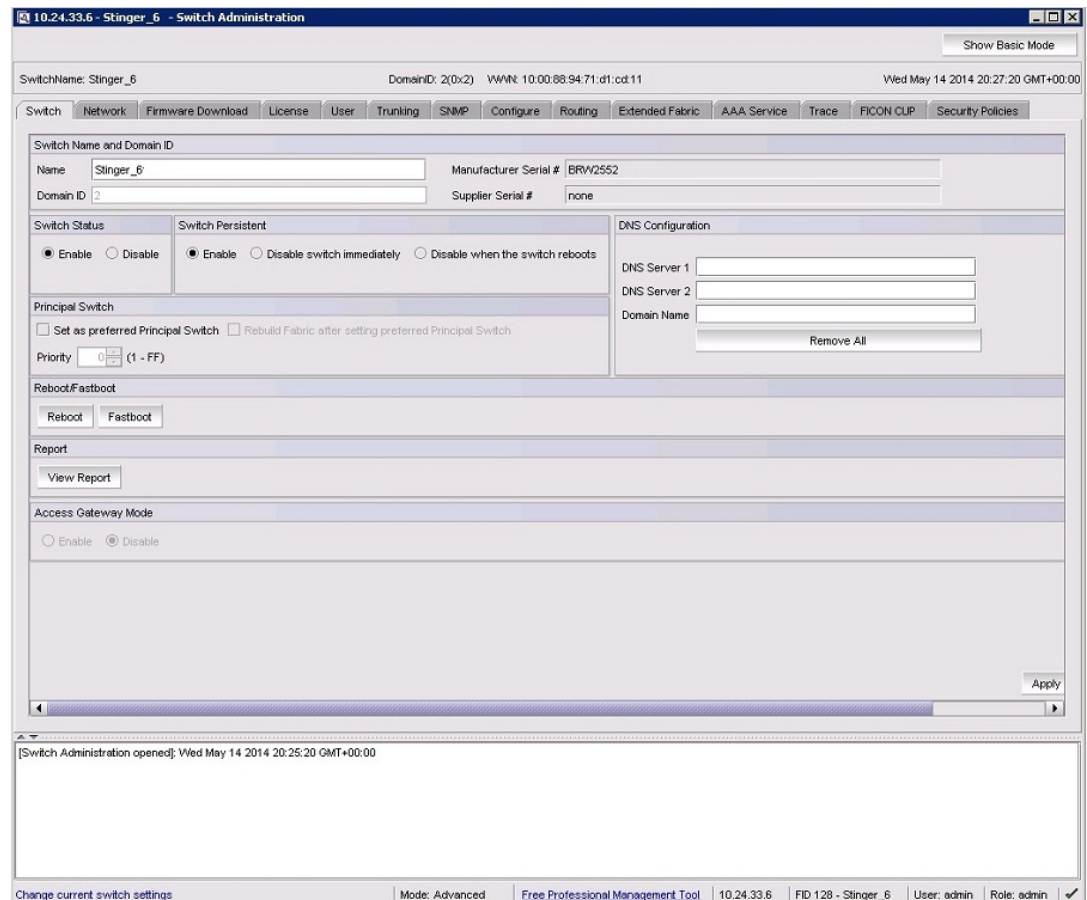

Configuring IP and subnet mask information

Before proceeding, collect all the information you need to configure the Ethernet IP interface. This includes the subnet mask, gateway IP address, or IPFC, and subnet mask for your system. When you configure or change the Ethernet IP, subnet mask, gateway IP, or IPFC, and subnet mask from Web Tools, there is a normal loss of network connection to the switch. Close all current windows and restart Web Tools with the new IP address.

NOTE

The IPFC address is specific for each logical switch. The IPFC address is set to FC0 for switches that do not support Virtual Fabrics.

To configure the IP and subnet mask information, perform the following steps.

1. Select the **Network** tab.
2. In the appropriate IP address section, enter the IP address you want to use for the IP interface.
Use the **IPv4 Address** section or the **IPv6 Address** section to specify IP addresses.
3. In the **IPv4 Address** section:
 - In the **Ethernet IP** field, enter the Ethernet IP address.
 - In the **IPFC Net IP** field, enter the IPFC net IP address.
 - In the **Ethernet Mask** field, enter the Ethernet mask address.
 - In the **IPFC Net Mask** field, enter the IPFC net mask address.
 - In the **Gateway IP** field, enter the gateway IP address.
4. In the **IPv6 Address** section, in the **Ethernet IPv6** field, enter the Ethernet IP address.
5. You can also enable automatic configuration of IPv6 addresses by selecting **Enable IPv6 Auto Configuration**.

The automatically generated IPv6 addresses are displayed under **Auto Configured IPv6 Addresses**. Eight auto-configured addresses are created per switch, and up to 24 for a DCX, or DCX-4S chassis (eight per chassis, and eight per each installed CP).

Configuring Netstat Auto Refresh

The Netstat Performance window displays the details about Ethernet management port statistics such as the Interface, MTU, Met, RX-OK, RX-ERR, RX-DRP, RX-OVR, TX-OK, TX-ERR, TX-DRP, TX-OVR, and Flag.

To configure Auto Refresh, perform the following steps.

1. Open the **Switch Administration** window as described in [Opening the Switch Administration window](#) on page 52.
2. Select the **Network** tab.
3. Click **Netstat Performance**.
4. Select the **Auto Refresh** check box to automatically refresh the port details.
Clear the check box to disable auto refresh.
5. When enabled, enter the interval time in seconds in the **Auto-Refresh Interval** field.

The port details are automatically refreshed, based on the configured time interval. The minimum value is 15 seconds.

Configuring a syslog IP address

The syslog IP address represents the IP address of the server that is running the syslog process. The syslog daemon reads and forwards system messages to the appropriate log files or users, depending on the system configuration. When one or more IP addresses are configured, the switch forwards all error log entries to the syslog on the specified servers. Up to six servers are supported. Refer to the *Fabric OS Administrator's Guide* for more information on configuring the syslog daemon.

To configure a syslog IP address, perform the following steps.

1. Open the **Switch Administration** window as described in [Opening the Switch Administration window](#) on page 52.
2. Select the **Network** tab.
3. In the **Syslog IP's Configuration** section, in the **New IP** field, enter an IP address in either IPv4 or IPv6 format.
4. Click **Add**.
The new IP address displays in the Syslog IP area.
5. Click **Apply**.

Removing a syslog IP address

To remove a syslog IP address, perform the following steps.

1. Open the **Switch Administration** window as described in [Opening the Switch Administration window](#) on page 52.
2. Select the **Network** tab.
3. Select a syslog IP address in the table and click **Remove**.
You can click **Clear All** to remove all of the syslog IP address from the table.
4. Click **Apply**.

Configuring IP filtering

Web Tools provides the ability to control what client IP addresses may connect to a switch or fabric.

To set up IP filtering, perform the following steps.

1. Open the **Switch Administration** window (in Basic mode) as described in [Opening the Switch Administration window](#) on page 52.
2. Click **Show Advanced Mode**.
3. Select the **Security Policies** tab.
4. Select **IP Filter** on the **Security Policies** menu.
5. Click **Create Policy**.

The **Create IP Filter Policy** dialog box displays.

6. Enter a policy name, select a policy type, and then click the **Add Rule** button.
7. Enter the rule order, rule type, source and destination IP addresses, and then modify the service or destination port, protocol, and action as necessary.

Both the source and destination IP addresses are needed for the FWD rule type.

Only the source IP address is needed for the INPUT rule type, as the destination IP address field is disabled.

8. Click **OK**.

After you create a policy, you can use the following controls on this tab to manage the policies:

- The **Edit Policy** button lets you select an existing policy and make changes to it.
- The **Show Policy** button lets you view the details of the policy in a read-only window.
- The **Delete Policy** button lets you delete a policy.

- The **Clone Policy** button lets you copy a policy. Use this feature when you want to create similar policies. After you create a clone, you can edit the policy to make the appropriate changes.
- The **Activate Policy** button lets you make an existing policy active.
- The **Distribute Policy** button lets you distribute a policy to various switches.
- The **Accepts Distribution** check box lets you set the policy to accept or reject distributions.

Blade management

Web Tools provides the ability to enable and disable blades, and to set slot-level IP addresses for blades. The procedure in this section applies only to the Brocade DCX 8510-4, Brocade DCX 8510-8, or the Brocade DCX, DCX-4S enterprise-class platforms.

Enabling or disabling a blade

The **Firmware Version** columns display the firmware loaded onto each blade. A blade can have more than one firmware image loaded onto it. The **Blade State** column in the **Blade** tab pane indicates whether the blade is enabled.

NOTE

The blade state is always shown as enabled, even if you perform a blade disable operation. When a blade is set to a disable state, only the ports on the blade are disabled. The blade remains active.

To enable or disable a blade, perform the following steps.

1. Open the **Switch Administration** window as described in [Opening the Switch Administration window](#) on page 52
2. Select the **Blade** tab.

FIGURE 9 Blade tab

Slot No	Blade Id	Blade Type	Firmware Version		Blade State	Power Consumption
			Primary	Secondary		
1	75	AP_BLADE	N/A	N/A	INSERTED, NOT POWERED ON	250
2	126	SW_BLADE	N/A	N/A	ENABLED	160
3	153	SW_BLADE	N/A	N/A	ENABLED	160
4	96	SW_BLADE	N/A	N/A	ENABLED	160
5	98	CORE_BLADE	N/A	N/A	ENABLED	240
6	50	CP_BLADE	7.3.0_main_M340	7.3.0_main_M340	STANDBY	40
7	50	CP_BLADE	7.3.0_main_M340	7.3.0_main_M340	ACTIVE	40
8	98	CORE_BLADE	N/A	N/A	ENABLED	240
9	97	SW_BLADE	N/A	N/A	ENABLED	140
10	0	UNKNOWN	N/A	N/A	VACANT	-
11	77	SW_BLADE	N/A	N/A	ENABLED	130
12	0	UNKNOWN	N/A	N/A	VACANT	-

3. Select **Blade Action** > **Enable Blade** for each blade you want to enable, or **Blade Action** > **Disable Blade** to disable a blade, and click **Yes** in the confirmation dialog box.

Disabling a blade does not turn off the blade, it disables the ports on the blade. You cannot enable or disable the CP blades.

Setting a slot-level IP address

To set an IP address, perform the following steps.

1. Open the **Switch Administration** window as described in [Opening the Switch Administration window](#) on page 52.
2. Select the **Blade** tab.
3. Click **Set IP address**.
4. Select a slot number from the list.
5. Enter the IP address, subnet mask, and Gateway IP address.
6. Select a type from the list.
7. Click **Add** to add the new entry to the table.

When you click **Add**, the values remain in the fields. The **Clear Gateway** and **Clear IP** buttons are available for clearing fields in the table.

NOTE

To remove a configuration, select a row in the table and click **Delete**.

8. Click **Apply** to save the values currently shown in the table or click **Cancel** to close the dialog box without saving any of your changes.
9. To update the switch with your changes, update the table using the **Add** and **Delete** buttons, and then click **Apply**.

Viewing IP addresses

If you want to view the IP addresses configured on the switch for the currently populated slots, use the **Show IP Address** button.

Use this procedure to display the IP addresses.

1. Open the **Switch Administration** window as described in [Opening the Switch Administration window](#) on page 52.
2. Select the **Blade** tab.
3. Click **Show IP Address**.
4. Scroll through the list to view all the information.
5. When you are finished, click **Close**.

Switch configuration

Use the **Switch** tab of the **Switch Administration** window to perform basic switch configuration. [Figure 7](#) on page 52 displays an example of the **Switch** tab.

Enabling and disabling a switch

You can identify whether a switch is enabled or disabled in the **Switch Administration** window by looking at the lower-right corner. If you pause the pointer over the icon, the system displays text that indicates the status of the switch.

Use this procedure to enable or disable a switch.

1. Open the **Switch Administration** window as described in [Opening the Switch Administration window](#) on page 52.
2. Select the **Switch** tab.
3. In the **Switch Status** section, click **Enable** to enable the switch or **Disable** to disable the switch.
4. Click **Apply**.

The system displays a confirmation window that asks if you want to save the changes to the switch. You must click **Yes** to save the changes.

Enabling and disabling switch persistent

Use this procedure to enable or disable switch persistent. By default, switch persistent is disabled.

1. Open the **Switch Administration** window as described in [Opening the Switch Administration window](#) on page 52.
2. Select the **Switch** tab.
3. In the **Switch Persistent** section, do one of the following:
 - Click **Enable** to enable the switch persistent.
 - Click **Disable switch immediately** to disable the switch persistent immediately.
 - Click **Disable when the switch reboots** to set the switch persistent in the disabled state and disable switch persistent on reboot.

The switch remains in the enabled or temporarily online state until it reboots. After reboot, the switch goes to the disabled state.

4. Click **Apply**.

The system displays a confirmation window that asks if you want to save the changes to the switch. You must click **Yes** to save the changes.

Changing the switch name

Switches can be identified by IP address, domain ID, World Wide Name (WWN), or switch names. Names must begin with an alphabetic character, but otherwise can consist of alphanumeric, hyphen, and underscore characters. The maximum number of characters is 30, unless FICON mode is enabled. When FICON mode is enabled, the maximum number of characters is 24.

NOTE

Some system messages identify a switch service by the chassis name. If you assign meaningful chassis names and switch names, system logs are easier to use.

1. Open the **Switch Administration** window as described in [Opening the Switch Administration window](#) on page 52.
2. Select the **Switch** tab.
3. Enter a new name in the **Name** field and click **Apply**.

Changing the switch domain ID

Although domain IDs are assigned dynamically when a switch is enabled, you can request a specific ID to resolve a domain ID conflict when you merge fabrics.

To change the switch domain ID, perform the following steps.

1. Open the **Switch Administration** window as described in [Opening the Switch Administration window](#) on page 52.
2. Disable the switch, as described in [Enabling and disabling a switch](#) on page 58.
3. Select the **Switch** tab.
4. Enter a new domain ID in the **Domain ID** field.

For IM0 (Brocade Native mode), the range of valid values is from 1 through 239.

5. Click **Apply**.
6. Enable the switch, as described in [Enabling and disabling a switch](#) on page 58.

Viewing and printing a switch report

The switch report includes the following information:

- A list of switches in the fabric
- Switch configuration parameters
- A list of ISLs and ports
- Name Server information
- Zoning information
- SFP serial ID information

To view or print a report, perform the following steps.

1. Open the **Switch Administration** window as described in [Opening the Switch Administration window](#) on page 52.
2. Select the **Switch** tab.
3. Click **View Report**.
4. In the new window that displays the report, view or print the report using your browser.

Setting a principal switch

To set the preference to a switch to become the next principal switch in the fabric, perform the following steps.

NOTE

Principal switch selection is not supported in Access Gateway mode.

1. Open the **Switch Administration** window as described in [Opening the Switch Administration window](#) on page 52.
2. Select the **Switch** tab.
3. In the **Principal Switch** section, perform one of the following actions to set the switch as a principal switch:
 - Select **Set as preferred Principal Switch** - The switch is set as the principal switch in the next fabric rebuild.
 - Select **Set as preferred Principal Switch** and then select **Rebuild Fabric after setting preferred principal switch** - The switch is set as the preferred principal switch with rebuild triggered forcefully.
 - Select **Set as preferred Principal Switch** and enter the priority value in a range from 1 through FF in the **Priority** field.

You can change the priority value and select the **Rebuild Fabric after setting preferred principal switch** option from a principal or a subordinate switch. The principal switch selection is based on the factors in the following table.

TABLE 7 Principal switch selection factors

	Priority value with force option	Expected behavior
Subordinate switch	Lesser than principal	Fabric rebuild occurs and the switch comes up as a principal switch.
	Greater than principal	Fabric rebuild occurs and the switch remains as a subordinate switch.

TABLE 7 Principal switch selection factors (Continued)

	Priority value with force option	Expected behavior
	Equal to principal	Fabric rebuild occurs and the principal switch is selected based on the WWN check (lower becomes principal switch).
Principal switch	Lesser than subordinate	No fabric rebuild, the switch remains principal.
	Greater than subordinate	Fabric rebuild occurs and the switch becomes subordinate.
	Equal to subordinate	Fabric rebuild occurs and the principal switch is selected based on the WWN check (lower becomes principal switch).

4. Click **Apply**.

Switch restart

When you restart the switch, the restart takes effect immediately. Ensure that there is no traffic or other management on the switch, because traffic is interrupted during the restart; however, frames are not dropped. Be sure to save your changes before the restart, because any changes not saved are lost.

Performing a fast boot

A fast boot reduces boot time significantly by bypassing the power-on self-test (POST).

To perform a fast boot, perform the following steps.

1. Open the **Switch Administration** window as described in [Opening the Switch Administration window](#) on page 52.
2. Click **Fastboot**.
3. On the **Fastboot Confirmation** window, click **Yes** to continue.
4. Click **Apply**.

Performing a reboot

To reboot the CP and execute the normal power-on booting sequence, perform the following steps.

1. Open the **Switch Administration** window as described in [Opening the Switch Administration window](#) on page 52.
2. Click **Reboot**.
3. On the **Reboot Confirmation** window, click **Yes** to continue.
4. Click **Apply**.

System configuration parameters

You must disable the switch before you can configure fabric parameters.

You can change the following system configuration parameters:

- Switch fabric settings
- Virtual channel settings
- Arbitrated loop parameters
- System services
- CSGlobal QoS mode settings
- Signed firmware

WWN-based persistent PID assignment

WWN-based PID assignment allows you to configure a PID persistently using a device's WWN. When the device logs in to the switch, the PID is bound to the device WWN. If the device is moved to another port in the same switch, or a new blade is hot-plugged, the device receives the same PID (area) at its next login. For information on configuring WWN-based PID assignment, refer to [Configuring fabric settings](#) on page 63.

This feature is deactivated by default. When the feature is enabled, bindings are created dynamically; as new devices log in, they automatically enter the WWN-based PID database. The bindings exist until you explicitly unbind the mappings through the CLI or change to a different addressing mode. If there are any existing devices when you enable the feature, you must manually enter the WWN-based PID assignments through the CLI.

Once WWN-based PID assignment is enabled, you must manually enter the WWN-based PID assignments through the CLI for any existing devices. Any new devices logging in are automatically entered in the WWN-based PID database. Current WWN-based PID bindings are cleared when you change to a different addressing mode.

PID assignments are supported for a maximum of 4096 devices; this includes both point-to-point and NPIV devices. The number of point-to-point devices supported depends directly on the areas available. For example, 448 are available on an enterprise-class platform and 256 are available on switches. When the number of entries in the WWN-based PID database reaches the number 4096 or areas are used up, the oldest unused entry is purged from the database to free up the reserved area for the new FLOGI. Refer to the following table for complete information.

TABLE 8 Switches that support WWN-based persistent PID on Web Tools

Platform	VF	Default switch	Logical switch	Area mode	FICON mode
DCX/DCX-4S DCX 8510-4 DCX 8510-8	Enabled	Yes, if dynamic area addressing is enabled in the default switch.	Yes	0	If 8-bit dynamic mode is enabled, FMS is not supported
				1	Can be set
				2	Not supported

TABLE 8 Switches that support WWN-based persistent PID on Web Tools (Continued)

Platform	VF	Default switch	Logical switch	Area mode	FICON mode
Brocade 5100 Brocade 5300 Brocade VA-40FC Brocade 6510 Brocade 6520 Brocade 7800 Brocade 7840	Enabled	Yes	Yes	Default-8 bit dynamic	Configurable
Brocade 300 Brocade 5100 Brocade 5300 Brocade VA-40FC Brocade 6510 Brocade 6520 Brocade 7800 Brocade 7840	Disabled	N/A	N/A	Default-8bit dynamic	Configurable

Configuring fabric settings

To configure the fabric settings, perform the following steps.

1. Open the **Switch Administration** window as described in [Opening the Switch Administration window](#) on page 52
2. Click **Show Advanced Mode**.
3. Select the **Configure** tab.
4. Select the **Fabric** subtab.
5. Make the fabric parameter configuration changes.
6. Click **Apply**.
7. Enable the switch as described in [Enabling and disabling a switch](#) on page 58.

Fabric settings

Configure the following fabric settings on the **Fabric** subtab of the **Configure** tab:

TABLE 9 Fabric settings

BB Credit	The buffer-to-buffer credit is the number of buffers available to attached devices for frame receipt. The default BB Credit is 16. The range of valid values is from 1 through 27.
R_A_TOV	Resource allocation timeout value (in milliseconds). This variable works with the E_D_TOV to determine switch actions when presented with an error condition. The default is 10000. The possible range is (2*E_D_TOV) -120000. Values must be multiples of 1000.

TABLE 9 Fabric settings (Continued)

E_D_TOV	Error detect timeout value (in milliseconds). This timer is used to flag a potential error condition when an expected response is not received within the set time. The valid range is 1000 - (R_A_TOV/2)
Datafield size	The largest possible data field size (in bytes). The range of valid values is from 256 through 2112.
Address mode	Displays the addressing mode present in the switch.
Sequence Level Switching	Select this check box to enable frames of the same sequence from a particular group to be transmitted together. When this option is not selected, frames are transmitted interleaved among multiple sequences. Under normal circumstances, sequence-level switching should be disabled for better performance. However, some host adapters have issues when receiving interleaved frames among multiple sequences.
Disable Device Probing	Set this mode only if the switch N_Port discovery process (PLOGI, PRLI, INQUIRY) causes an attached device to fail. When set, devices that do not register with the Name Server are not present in the Name Server database.
Per-Frame Routing Priority	Select whether to select per-frame routing priority. When enabled, the virtual channel ID is used in conjunction with a frame header to form the final virtual channel ID.
Suppress Class F Traffic	Applies only if VC-encoded address mode is also set. When selected, translatable addressing (which allows private devices to communicate with public devices) is disabled.
Insistent Domain ID Mode	Set this mode to make the current domain ID insistent across reboots, power cycles, and failovers. This mode is required fabric-wide to transmit FICON data.
WWN-based Persistent PID	Set this mode to configure a PID persistently using a device's WWN. When the device logs in to the switch, the PID is bound to the device WWN. Refer to WWN-based persistent PID assignment on page 62.

Enabling insistent domain ID mode

To enable insistent domain ID mode, perform the following steps.

1. Open the **Switch Administration** window as described in [Opening the Switch Administration window](#) on page 52.
2. Disable the switch as described in [Enabling and disabling a switch](#) on page 58.
3. Select the **Configure** tab.
4. Select the **Fabric** subtab.
5. Select the **Insistent Domain ID Mode** check box.
6. Click **Apply**.
7. Enable the switch as described in [Enabling and disabling a switch](#) on page 58.

Configuring virtual channel settings

You can configure parameters for eight virtual channels (VCs) to enable fine-tuning for a specific application. You cannot modify the first two virtual channels because these are reserved for switch internal functions.

ATTENTION

The default virtual channel settings are already optimized for switch performance. Changing the default values can improve switch performance, but can also degrade performance. Do not change these settings without fully understanding the effects of the changes.

VC Priority specifies the class of frame traffic given priority for a virtual channel.

To configure the virtual channel settings, perform the following steps.

1. Open the **Switch Administration** window as described in [Opening the Switch Administration window](#) on page 52
2. Disable the switch as described in [Enabling and disabling a switch](#) on page 58.
3. Select the **Configure** tab.
4. Select the **Virtual Channel** subtab.
5. Enter a value in the **VC Priority** field you want to change.

The only valid numeric values for all fields are either "2" or "3".

6. Click **Apply**.
7. Enable the switch as described in [Enabling and disabling a switch](#) on page 58.

Configuring arbitrated loop parameters

To configure arbitrated loop parameters, perform the following steps.

1. Open the **Switch Administration** window as described in [Opening the Switch Administration window](#) on page 52.
2. Disable the switch as described in [Enabling and disabling a switch](#) on page 58.
3. Select the **Configure** tab.
4. Select the **Arbitrated Loop** subtab.
5. Select or clear the check boxes to enable or disable the corresponding arbitrated loop parameters.
6. Click **Apply**.
7. Enable the switch as described in [Enabling and disabling a switch](#) on page 58.

Arbitrated loop parameters

Configure the following arbitrated loop parameters on the **Arbitrated Loop** subtab of the **Configure** tab.

TABLE 10 Arbitrated loop parameters

Send Fan Frames	Select this check box to specify that fabric address notification (FAN) frames are sent to public loop devices to notify them of their node ID and address.
Always Send RSCN	Following the completion of loop initialization, a remote state change notification (RSCN) is issued when FL_Ports detect the presence of new devices or the absence of pre-existing devices. Select this check box to issue an RSCN upon completion of loop initialization, regardless of the presence or absence of new or pre-existing devices.

Configuring system services

You can enable or disable FCP read link status (RLS) probing for F_Ports and FL_Ports. It is disabled by default.

To configure system services, perform the following steps.

1. Open the **Switch Administration** window as described in [Opening the Switch Administration window](#) on page 52.
2. Disable the switch as described in [Enabling and disabling a switch](#) on page 58.
3. Select the **Configure** tab.
4. Select the **System** subtab.
5. Select the **Disable RLS Probing** check box to *disable* RLS probing.
or
Clear the check box to *enable* RLS probing.
6. Click **Apply**.
7. Enable the switch as described in [Enabling and disabling a switch](#) on page 58.

Configuring CSCTL QoS mode

You can configure switch-level Class-Specific Control (CSCTL) Quality of Service (QoS) mode.

To configure CSCTL QoS mode, perform the following steps.

1. Open the **Switch Administration** window as described in [Opening the Switch Administration window](#) on page 52.
2. Select the **Configure** tab.
3. Select the **CSCTL QoS Mode** subtab.
4. Select either of the following options:
 - **Default** - This is the default option. The **Default** option clears any previously configured CSCTL to VC mapping and sets one-to-one mapping between the CSCTL value and the VC number.
 - **Auto** - This option maps the CSCTL value to more than one VC.
5. Click **Apply**.

Configuring signed firmware

When the firmware is downloaded to a device, the system can validate the firmware based on a configuration setting. By default, the signed firmware download is not validated.

NOTE

During the first download, the system ignores the signed firmware. After the first download, the public key is downloaded and then, in subsequent downloads, you can turn on the feature. You can view the public key on the **Firmware Download** tab in the **Switch Administration** window.

To configure the signed firmware, perform the following steps.

1. Open the **Switch Administration** window as described in [Opening the Switch Administration window](#) on page 52.
2. Select the **Configure** tab.
3. Select the **Firmware** subtab.

4. Select the **Enable Signed Firmware Download** check box.
5. Click **Apply**.

Licensed feature management

The licensed features currently installed on the switch are listed in the **License** tab of the **Switch Administration** window. If the feature is listed, such as the EGM license, it is installed and immediately available. When you enable some licenses, such as ISL Trunking, you might need to change the state of the port to enable the feature on the link. For time-based licenses, the expiry date is included. Right-click a license key to export data, copy data, or search the table.

Activating a license on a switch

Before you can unlock a licensed feature, you must obtain a license key. You can either use the license key provided in the paperpack document supplied with switch software or refer to the *Fabric OS Administrator's Guide* for instructions on how to obtain a license key at the Brocade website (my.brocade.com).

To activate a license, perform the following steps.

1. Open the **Switch Administration** window as described in [Opening the Switch Administration window](#) on page 52.
2. Select the **License** tab and click **Add**.
The **Add License** dialog box displays.
3. Paste or enter a license key in the field.
4. Click **Add License**.
5. Click **Refresh** to display the new licenses in the **License** tab.

Some licenses, such as the Brocade 7800 upgrade license, do not take effect until the switch is restarted.

Assigning slots for a license key

Slot-based licensing feature allows you to increase the capacity without disrupting the slots that already have licensed features running.

NOTE

You can enable slot-based licenses only on the 10 Gigabit Ethernet (FTR_10G), Advanced Extension (FTR_AE), and Advanced FICON Acceleration (FTR_AFA) features.

The Brocade 7840 Extension switch require 'WAN Rate Upgrade 1' and 'WAN Rate Upgrade 2' licenses with the capacity value set to "1" .

To assign slots for a license key, perform the following steps.

1. Open the **Switch Administration** window as described in [Opening the Switch Administration window](#) on page 52.
2. Select the **License** tab.
3. Select the license key for which you want to assign slots from the **License Administration** table.

4. Click **Assign Slot(s)**.
The **Assign Slots** window displays.
5. Select the slots you want to assign.
6. Click **OK**.

NOTE

The **Assign Slot(s)** option is not supported in pizza box switches.

Removing a license from a switch

To remove a license from a switch in the **Switch Administration** window, perform the following steps.

ATTENTION

Use care when removing licenses. If you remove a license for a feature, that feature no longer works.

1. Open the **Switch Administration** window as described in [Opening the Switch Administration window](#) on page 52.
2. Select the **License** tab.
3. Select the license key you want to remove.
4. Click **Remove**.

Universal time-based licensing

Web Tools supports universal time-based licensing. Each universal key is for a single feature, and can be used on any product that supports the feature, for a defined trial period. At the end of the trial period, the feature gets disabled. You can extend the universal key license. For time-based licenses, the **Expiry Date** displays in the **License Administration** table.

The following features are supported for universal time-based licensing:

- Fabric
- Extended Fabric
- Fabric Watch
- Performance Monitor
- Trunking
- High-Performance Extension over FCIP/FC
- Advanced Extension
- Advanced FICON Acceleration
- FICON Management Server (CUP)
- Enhanced Group Management (EGM)
- 10 GbE
- Integrated Routing
- Adaptive Networking (obsoleted from Fabric OS v7.2.0)
- Server Application Optimization (obsoleted from Fabric OS v7.2.0)
- Extended Inter-Chassis Link (EICL) license

High Availability overview

High Availability (HA) features provide maximum reliability and nondisruptive replacement of key hardware and software modules. High Availability is available only on the Brocade DCX, DCX-4S, DCX 8510-4, and DCX 8510-8 platforms. Refer to the *Fabric OS Administrator's Guide* for additional information about High Availability.

The **High Availability** window, displays information about the status of the HA feature on each control processor (CP), and enables you to perform CP failover.

The background color of the HA button indicates the overall status of High Availability on the switch. The colors and their meanings are:

- Green--Healthy: HA Status is **HA enabled, Heartbeat Up, HA State synchronized**.
- Yellow--Disruptive mode: HA Status is **HA enabled, Heartbeat Up, HA State not in sync**.
- Red--HA is unavailable: HA Status is **Non-Redundant**.

Admin Domain considerations

HA is possible if the switch is a member of the current Admin Domain. If the switch is not a member of the current Admin Domain, the **Synchronize Services** and **Initiate Failover** buttons are unavailable.

Launching the High Availability window

To launch the **High Availability** window, perform the following steps.

1. Select a Brocade DCX, DCX-4S, DCX 8510-4, or DCX 8510-8 platforms from the **Fabric Tree**.

The **Switch View** displays.

2. Click the **HA** button in the **Switch View**.

The **High Availability** window displays.

The **High Availability** window contains the following two tabs:

- The **Service** tab displays information about the switch. When the hardware is configured as a dual switch, the **Service** tab displays information about both switches.
- The **CP** tab displays information about slots. For the Brocade DCX-4S or DCX 8510-4, CP blades are placed in slot 4 and slot 5. For the Brocade DCX or DCX 8510-8, CP blades are placed in slot 6 and slot 7.

FIGURE 10 High Availability window, CP tab

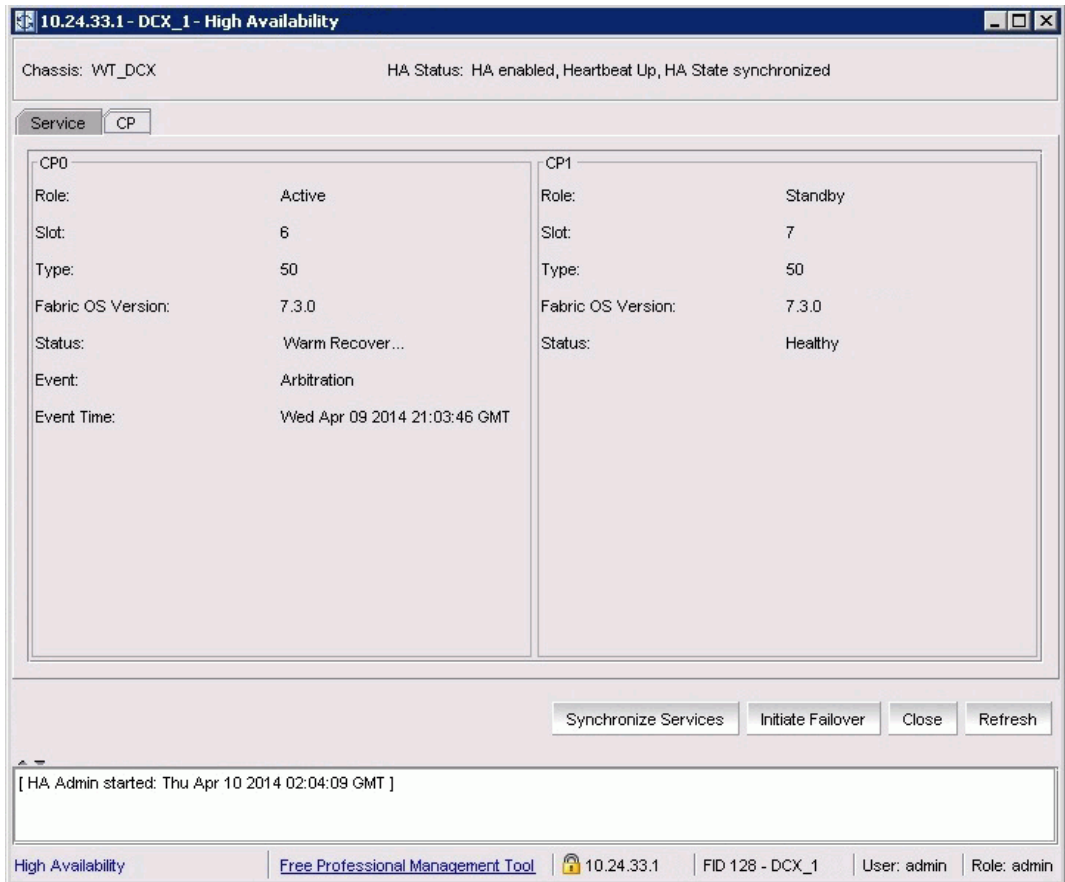

The **High Availability** window gets refreshed automatically. You can also click **Refresh** to update the information displayed in the **High Availability** window.

Admin Domain considerations

To open the **High Availability** window, the switch must be a member of your current Admin Domain. If the switch is not a member of the current Admin Domain, the **Synchronized Services** and **Initiate Failover** buttons are unavailable.

Synchronizing services on the CP

A nondisruptive CP failover is only possible when all the services are synchronized between both CPs.

To synchronize services on the CP, perform the following steps.

1. Open the **High Availability** window.
2. Verify that the **HA Status** field displays **HA enabled, Heartbeat Up, HA State synchronized**.

If the **HA Status** field displays **HA enabled, Heartbeat Up, HA State synchronized**, then the services are in sync.

If the **HA Status** field displays **HA enabled, Heartbeat Up, HA State not in sync**, continue with step 3.

3. Click **Synchronize Services**.

The **Warning** dialog box displays.

4. Click **Yes** and wait for the CPs to complete a synchronization of services, so that a nondisruptive failover is ready.
5. Click **Refresh** to update the **HA Status** field.

When the **HA Status** field displays **HA enabled, Heartbeat Up, HA State synchronized**, a failover can be initiated without disrupting frame traffic on the fabric.

Initiating a CP failover

A nondisruptive failover might take about 30 seconds to complete. During the failover, all of the Web Tools windows and all associated child-windows are invalidated. You must close all Web Tools windows and open Web Tools again.

To initiate a nondisruptive failover, perform the following steps.

1. Open the **High Availability** window.
2. Verify that the **HA Status** field displays **HA enabled, Heartbeat Up, HA State synchronized** or **HA enabled, Heartbeat Up, HA State not in sync**.
3. Click **Initiate Failover**.

The **Warning** dialog box displays.

4. Click **Yes** to initiate a nondisruptive failover.
5. When prompted, close the Web Tools **Switch Explorer** window and all associated windows, and re-open Web Tools.

Event monitoring

Web Tools displays fabric-wide and switch-wide events. Event information includes sortable fields for the following:

- Switch name
- Message number
- Time stamp
- Indication of whether the event is from a logical switch or a chassis
- The number of successive events of the same kind
- Severity level
- Unique message identifier (in the form *moduleID -messageType*)
- Detailed error message for root cause analysis

There are six message severity levels:

- Critical
- Alert
- Error
- Warning
- Information
- Debug

The following table lists the event message severity levels displayed on the **Switch Events** tab and explains what qualifies event messages to be certain levels.

On the **Switch Events** tab, you can click **Filter** to launch the **Event Filter** dialog box. The **Event Filter** dialog box allows you to define which events should be displayed on the **Switch Events** tab. For more information on filtering events, refer to [Filtering switch events](#) on page 72.

TABLE 11 Event severity levels

Level	Description
Critical	Critical-level messages indicate that the software has detected serious problems that will eventually cause a partial or complete failure of a subsystem if not corrected immediately. For example, a power supply failure or rise in temperature must receive immediate attention.
Alert	This event does not compromise data or prevent the use of the system; however, the event warrants your attention.
Error	Error-level messages represent an error condition that does not impact overall system functionality significantly. For example, error-level messages might indicate timeouts on certain operations, failures of certain operations after retries, invalid parameters, or failure to perform a requested operation.
Warning	Warning-level messages highlight a current operating condition that should be checked or it might lead to a failure in the future. For example, a power supply failure in a redundant system relays a warning that the system is no longer operating in redundant mode. The failed power supply must be replaced or fixed.
Info	Information-level messages report the current nonerror status of the system components, such as the online and offline status of a fabric port.
Debug	Debug messages deliver status messages relating to debugging systems.

Displaying switch events

The **Switch Events** tab displays a running log of events for the selected switch. Switch events are polled and updated every 15 seconds; there is no refresh-on-demand option for switch events.

For two-switch configurations, all chassis-related events are displayed in the event list of each logical switch for convenience.

To display switch events, perform the following steps.

1. Select the switch from the **Fabric Tree** .
The **Switch View** displays.
2. Select the **Switch Events** tab, if necessary.

Filtering switch events

You can filter the fabric and switch events by time, severity, message ID, and service. You can apply either one type of filter at a time or multiple types of filters at the same time. When a filter is applied, the filter information displays at the bottom of the filtered information and the **Show All** link is available to allow you to view the information unfiltered.

To filter switch events, perform the following the procedure.

1. Open the **Switch Events** tab as described in [Displaying switch events](#) on page 72.
2. Click **Filter** .
The **Event Filter** dialog box displays.

3. To filter events within a certain time period:
 - Select the **From** check box and enter the start time and date in the fields.
 - Select the **To** check box and enter the finish time and date in the fields.
 - To filter events beginning at a certain date and time, select only the **From** check box and enter the start time and date.
 - To filter events up until a certain date and time, select only the **To** check box and enter the finish time and date.

4. Click **OK**.

The filter is enabled and the window is refreshed to show the filtered information.

Filtering events by event severity levels

To filter events by event severity levels, perform the following steps.

1. Open the **Switch Events** tab as described in [Displaying switch events](#) on page 72.
2. Click **Filter**.

The **Event Filter** dialog box displays.

3. Select **Level**.
4. Select the event levels you want to display.
5. Click **OK**.

The filter is enabled and the window is refreshed to show the filtered information.

Filtering events by message ID

To filter events by message ID, perform the following steps.

1. Open the **Switch Events** tab as described in [Displaying switch events](#) on page 72.
2. Click **Filter**.

The **Event Filter** dialog box displays.

3. Select **Message ID**.
4. Enter the message IDs in the associated field.

NOTE

You can enter multiple message IDs as long as you separate them by commas. You can enter either the full message ID (moduleID-messageType) or a partial ID (moduleID only). The message ID filtering is case-sensitive.

5. Click **OK**.

The filter is enabled and the window is refreshed to show the filtered information.

Filtering events by service component

To filter events by service component, perform the following steps.

1. Open the **Switch Events** tab as described in [Displaying switch events](#) on page 72.
2. Click **Filter**.

The **Event Filter** dialog box displays.

3. Select **Service**. The event service menu is enabled.
4. Select either **Switch** or **Chassis** from the menu to show only those messages from the logical switch or from the chassis.
5. Click **OK**.

The filter is enabled and the window is refreshed to show the filtered information.

Displaying the Name Server entries

Web Tools displays Name Server entries listed in the Simple Name Server database. This includes all Name Server entries for the fabric, not only those related to the local domain. Each row in the table represents a different device. You can click the column head to sort the events by a particular column, and drag the column divider to resize a column. You can also right-click a column heading to resize one or all columns, sort the information in ascending or descending order, or select which columns are displayed.

Admin Domain considerations: The **Name Server** table is filtered based on Admin Domain membership of the fabric devices. The **Name Server** table lists only devices that are part of your current Admin Domain. This includes devices that are direct members of the Admin Domain and devices that are attached to ports that are direct members of the Admin Domain. All other fabric devices are filtered out of the **Name Server** view for the current Admin Domain. Refer to [Admin Domain membership](#) on page 87 for information about direct and indirect members.

For FICON devices: The **Name Server** table lists the request node identification (RNID) information.

To display the Name Servers, perform the following steps.

1. In the **Switch Explorer** window, select **Name Server**.
The **Name Server** tab displays.
2. To set an auto-refresh rate for the **Name Server** entries, select the **Auto Refresh** check box in the **Name Server** window, and enter an auto-refresh interval (in seconds).

The minimum interval is 45 seconds and the default interval is 60 seconds.

Printing the Name Server entries

To set up printing preferences, perform the following steps.

1. In the **Switch Explorer** window, select **Name Server**.
The **Name Server** tab displays.
2. Click **Print**.
3. On the **Page Setup** dialog box, set up your printing preferences and click **OK**.
The **Print** dialog box displays.
4. Select a printer and click **OK**.

Displaying Name Server information for a particular device

To display Name Server information for a particular device, perform the following steps.

1. In the **Switch Explorer** window, select **Name Server**.

The **Name Server** tab displays.

2. Select a device from the **Domain** column.
3. Click **Detail View**.

The **Name Server Information** dialog box displays the information specific to that device.

Displaying zone members for a particular device

To display zone members for a particular device, perform the following steps.

1. In the **Switch Explorer** window, select **Name Server**.

The **Name Server** tab displays.

2. Select a device from the **Domain** column.
3. Click **Accessible Devices**.

The **Zone Accessible Devices** window displays accessible zone member information specific to that device.

Physically locating a switch using beaconing

Use the **Beacon** button to physically locate a switch in a fabric. The beaconing function helps to physically locate a switch by sending a signal to the specified switch, resulting in an LED light pattern that cycles through all ports for each switch (from left to right).

NOTE

You must have an RBAC role of admin to initiate switch beaconing. The LED light pattern is initiated on the actual switch or chassis. It is not mirrored in the **Switch View**.

To use beaconing, perform the following steps.

1. Select a logical switch from the **Logical Switch** list in the top-right corner of the **Switch Explorer** window.

The selected switch displays in the **Switch View**.

2. Select **Tools > Beacon > Beacon** for a switch or **Chassis Beacon** for a chassis-based switch.

The LEDs on the actual switch light up on the physical switch in a pattern running back and forth across the switch itself. In chassis-based switches, the LEDs glow across all the blades.

3. Look at the physical switches in your installation location to identify the switch.

Locating logical switches using chassis beaconing

To locate all logical switches in a chassis, perform the following steps.

1. Select a logical switch from the **Logical Switch** list in the top-right corner of the **Switch Explorer** window.

The selected switch displays in the **Switch View**.

2. Select **Tools > Beacon > Chassis Beacon**.

The LEDs on the logical switch light up on the blades associated with the logical switch.

Virtual Fabrics overview

Virtual Fabrics is an architecture that virtualizes hardware boundaries. Traditionally, SAN design and management is done at the granularity of a physical switch. Each switch and all the ports in the switch act as a single fabric element that participates in a single fabric. Virtual Fabrics allows SAN design and management to be done at the granularity of a port. This enables partitioning of a physical switch into multiple logical switches, which may be organized into logical fabrics.

The following platforms are Virtual Fabrics-capable:

- Brocade DCX and DCX-4S
- Brocade 5300
- Brocade 5100
- Brocade 6510
- Brocade 6520
- Brocade 7800
- Brocade 7840
- Brocade DCX 8510-4
- Brocade DCX 8510-8

Virtual Fabrics cannot be configured or managed from Web Tools. Configuration and management is done from either the Brocade Network Advisor, or the Fabric OS command line interface. For information about configuring and managing Virtual Fabrics, refer to the *Brocade Network Advisor User Manual* if you are using Brocade Network Advisor, or *the Fabric OS Administrator's Guide* if you are using the Fabric OS command line interface.

You can use Web Tools to view Virtual Fabrics and logical switch configurations.

Selecting a logical switch from the Switch View

You can log in to a specific logical switch, as described in [Introducing Web Tools](#) on page 19 , or you can select a logical switch from the **Switch View** . If you do not log in to a specific logical switch, you are presented with the default logical switch.

Under the **Switch Information** tab, **Base Switch**, **Default Switch**, and **Allow XISL Use** are specific to Virtual Fabrics. These options perform these functions:

- **Base Switch** indicates whether or not the logical switch can act as a base switch. A base switch is a special logical switch that can be used for chassis interconnection. Each chassis may only designate only one logical switch as a base switch.
- **Default Switch** indicates whether or not the logical switch is the default logical switch. The default logical switch is equivalent to the normal, discovered physical switch topology. It is automatically assigned fabric ID 128. If you do not log in to a specific logical switch using **Options** on the login dialog box, the default logical switch displays in the **Switch View**.
- **Allow XISL Use** indicates whether or not the logical switch is allowed to connect to other logical switches using an extended inter-switch link (XISL). Base switches may use XISLs. Dynamically created logical switches can use the XISL for traffic, only if **Allow XISL Use** is enabled through the CLI using the **configure** command.

To select a logical switch, perform the following steps.

1. Use the **Logical Switch** list to select the fabric ID.

You must have the EGM license installed to view the Logical Switch selection on a Brocade 5100, 5300, or VA-40FC. A dialog box displays asking you to confirm your selection.

2. Click **Yes** to confirm.

The selected logical switch displays.

Viewing logical ports

When base switches are connected through XISLs, a base fabric is formed that includes logical switches in different chassis. A logical link is formed dynamically among logical switches that have the same FID to carry frames between the logical switches. Logical ports are created in the respective switches to support the logical link.

Logical ports are software constructs, and have no corresponding hardware to represent them on the **Switch View**. Logical port information is available in the **Port Admin** tab.

1. Select the **Port Admin** tab. The **Port Admin** tab displays. Logical ports are displayed in the **FC Ports Explorer** tree structure.
2. To view logical port properties, expand the **Logical Ports** branch, and select a port. The **General** properties are displayed.

FIGURE 11 Logical ports

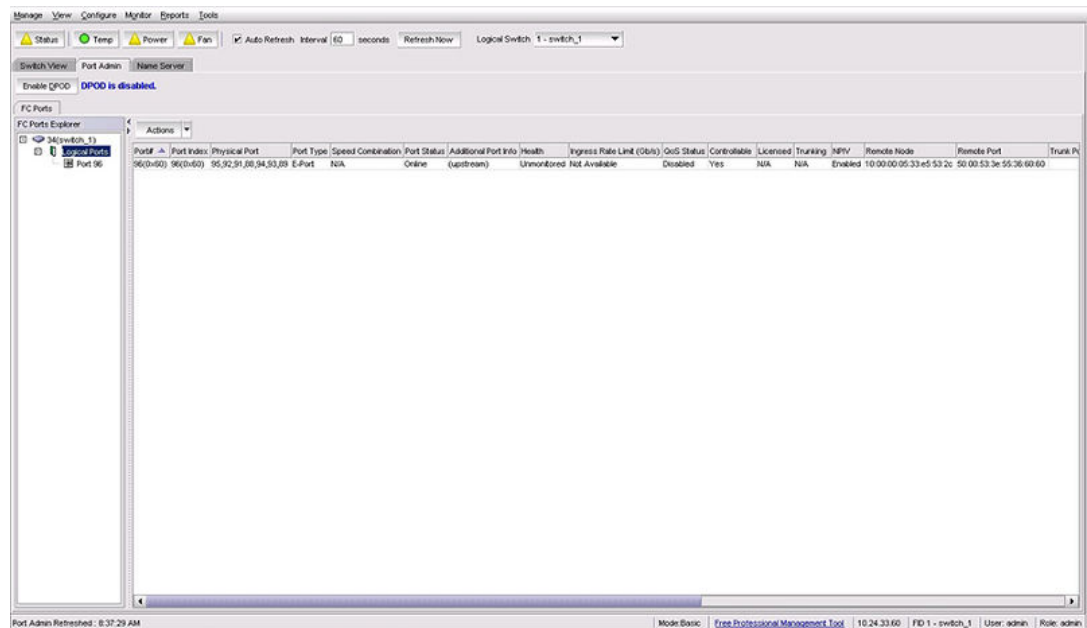

Maintaining Configurations and Firmware

- [Creating a configuration backup file](#)..... 79
- [Restoring a configuration](#)..... 80
- [Admin Domain configuration maintenance](#)..... 81
- [Uploading and downloading from USB storage](#)..... 82
- [Performing a firmware download](#)..... 82

Creating a configuration backup file

Keep a backup copy of the configuration file in case the configuration is lost or unintentional changes are made. You should keep individual backup files for all switches in the fabric. You should avoid copying configurations from one switch to another.

If you upload from a network, enter the host name or IP address in the **Host Name or IP** field, the user ID and password required for access to the host in the **User Name** and **Password** fields, and select the **Protocol Type** used for the upload. The default is FTP. If you select "Secure Copy Protocol (SCP)" or "Secure File Transfer Protocol (SFTP)", you cannot specify "anonymous" in the **User Name** field.

An **info** link is enabled when USB is chosen as the source of the configuration file. If you click on **info** , an information message displays as shown in the following figure.

FIGURE 12 Information dialog box

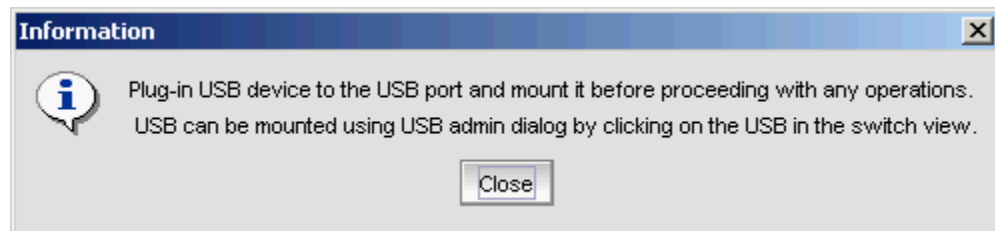

To create a configuration backup file, perform the following task.

1. Select **Configure > Switch Admin**.

The **Switch Administration** window displays.

2. Select **Show Advanced Mode**.
3. Select the **Configure** tab.
4. Select the **Upload/Download** tab.

By default, **Config Upload** is chosen under **Function**, and **Network** is chosen as the source of the configuration file.

5. Enter the configuration file with a fully-qualified path, or select the configuration file name in the **Configuration File Name** field.

The default path for Windows is **Folder Name\FileName.txt** or **FileName.txt**

The default path for Linux is **Directory Name\FileName.txt** or **FileName.txt**.

If you select USB as the configuration file source, the network parameters are not needed and are not displayed. You can skip to step 6.

6. Use the **Fabric ID** selector to select the fabric ID of the logical switch from which the configuration file is to be uploaded.

The selector displays all the Virtual Fabric IDs that have been defined, the default of 128 for the physical switch, chassis level configuration, and all chassis and switches.

FIGURE 13 Fabric ID selector

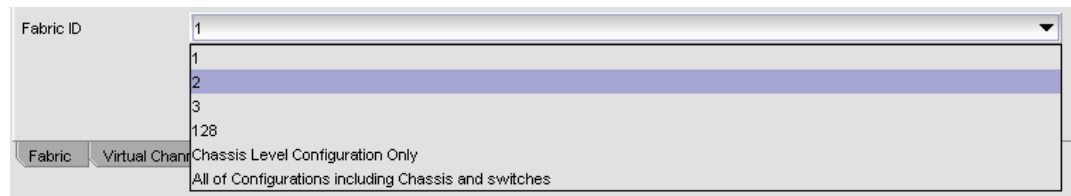

NOTE

If you are using a USB device, it must be connected and mounted before you upload or download. Refer to [Uploading and downloading from USB storage](#) on page 82 for more information.

7. Click **Apply**.

You can monitor the progress by watching the **Upload/Download Progress** bar.

Restoring a configuration

Restoring a configuration involves overwriting the configuration on the switch by downloading a previously saved backup configuration file. Perform this procedure during a planned down time.

Make sure that the configuration file you are downloading is compatible with your switch model. Configuration files from other model switches might cause your switch to fail.

If you download from a network, enter the host name or IP address in the **Host Name or IP** field, the user ID and password required for access to the host in the **User Name** and **Password** fields, and select the **Protocol Type** used for the upload. The default is FTP. If you select "Secure Copy Protocol (SCP)" or "Secure File Transfer Protocol (SFTP)," you cannot specify "anonymous" in the **User Name** field.

To restore a configuration, perform the following task.

1. Open the **Switch Administration** window.
2. Select **Show Advanced Mode**.
3. Select the **Configure** tab.
4. Select the **Upload/Download** tab.

By default, **Config Upload** is chosen under **Function**, and **Network** is chosen as the source of the configuration file.

5. Under **Function**, select **Config Download to Switch**.

If you select USB as the configuration file source, the network parameters are not needed and are not displayed, and you can skip to step 7.

An **info** link is enabled when USB is chosen as the source of the configuration file. If you click **info**, an information message displays.

6. Enter the configuration file with a fully-qualified path, or select the configuration file in the **Configuration File Name** field.
7. Use the **Fabric ID** selector to select the fabric ID of the logical switch to which the configuration file is to be downloaded.

The selector displays all the Virtual Fabric IDs that have been defined, the default of 128 for the physical switch, chassis level configuration, and all chassis and switches.
8. Enter the fabric ID of the logical switch in **Template Fabric ID**.

NOTE

If you are using a USB device, it must be connected and mounted before you upload or download. Refer to [Uploading and downloading from USB storage](#) on page 82 for more information.

9. Click **Apply**.

You can monitor the progress by watching the **Upload/Download Progress** bar.

Admin Domain configuration maintenance

When you log in to the switch as a physical fabric administrator and back up a configuration, all local switch configuration parameters are saved, as well as all Admin Domain membership information and Admin Domain zone databases.

To perform a configuration upload or download, you should have the Admin Domain of AD255 or AD0, if no other user-defined Admin Domains exist. A configuration upload or download gathers all the configuration files for the fabric, including Admin Domains. For more information on Admin Domains, refer to [Requirements for Admin Domains](#) on page 85.

When the configuration is backed up, one of the following scenarios is possible:

- If the current Admin Domain does not own the switch and you are logged in with any role that allows configuration upload or download, the following items are saved in the configuration file:
 - Local zone configuration
 - No other configuration information
- If the current Admin Domain owns the switch and you are logged in with any role that allows configuration upload or download, the following items are saved in the configuration file:
 - Local zone configuration
 - All other configuration information except Admin Domain configuration information
- If you invoke Admin Domain from AD255 and you are logged in with any role that allows configuration upload or download, the following items are saved in the configuration file:
 - Configuration information for zones in all Admin Domains
 - All other configuration information, including zoning from all Admin Domains

The filtering depends on the Admin Domain switch ownership, with additional access if you are in AD255. Access to the command itself is limited by Role-Based Access Control (RBAC), and not by whether the current user is a Physical Fabric Administrator or an admin user with enumerated access to the relevant domains.

The ability to change Admin Domain context requires installing the EGM license. Refer to [Changing the Admin Domain context](#) on page 41 for complete instructions.

The EGM license is required only for 8 Gbps platforms, such as the:

- Brocade Encryption Switch
- Brocade 300, 5300, and 5100 switches

- Brocade VA-40FC
- Brocade 7800

For non-8 Gbps platforms, all functionalities are available without the EGM license.

Uploading and downloading from USB storage

If you choose to upload or download from a USB device, you must click the USB port to launch the USB Port Management wizard.

To update your USB storage, perform the following steps.

1. Select **Mount USB Device**, and select **Yes** at the confirmation prompt.
2. Right-click a configuration file to access **Export**, **Copy**, and **Search** options.
3. Click **Copy** to upload and **Export** to download.

Performing a firmware download

During a firmware download, the switch restarts and the browser temporarily loses connection with the switch. When the connection is restored, the version of the software running in the browser is different from the new software version that was installed and activated on the switch. You must close all of the Web Tools windows and log in again to avoid a firmware version mismatch. Note that for chassis-based switches, you might get pop-up messages that imply the loss of connection is temporary and will soon be resolved. You must still close all windows and log in again.

When you request a firmware download, the system first checks the file size being downloaded. If the compact flash does not have enough space, Web Tools displays a message and the download does not occur. If this happens, contact your switch support supplier.

NOTE

You can perform a firmware download only when the current Admin Domain owns the switch.

To download a new firmware version, perform the following steps.

1. Open the **Switch Administration** window as described in [Opening the Switch Administration window](#) on page 52.
2. Select the **Firmware Download** tab.
3. Select **Firmware**.

The download source can be located on the **Network** or a **USB** device.

NOTE

When you select the **USB** button, you can specify only a firmware path or directory name. The default path for Windows and Linux is `/usb/usbstorage/brocade/firmware/<version>` No other fields on the tab are available. The **USB** button is available if the USB is present on the switch.

4. Enter the host name or IP address, user name, password, and fully-qualified path to the file `release.plist`.

You can enter the IP address in either IPv4 or IPv6 format.

The path name should use the following structure:

```
//<directory>/<fos_version_directory>/release.plist
```

In this syntax, the *<directory>* is the path up to the entry point of *<fos_version_directory>* and *<fos_version_directory>* is where the unzipped version of Fabric OS is located, for example:

```
//directory_1/my_directory/v7.0.0/release.plist
```

5. Select the protocol type in the **Protocol Type** field.

If you select "Secure Copy Protocol (SCP)" or "Secure File Transfer Protocol (SFTP)", you cannot specify "anonymous" in the **User** field.

6. Click **Apply**.

The firmware download begins. You can monitor the progress by looking at the **Firmware Download** progress bar.

NOTE

About halfway through the download process, after the firmware is downloaded to the switch, connection to the switch is lost and Web Tools invalidates the current session. Web Tools invalidates all windows because upfront login is always enabled and cannot be disabled.

7. Close all Web Tools windows and log in again.

If the firmware download is in progress when you log in, you can continue to monitor its progress.

Performing a firmware download

Managing Administrative Domains

- [Administrative Domain overview](#)..... 85
- [Enabling Admin Domains](#)..... 87
- [Admin Domain window](#)..... 87
- [Creating and populating domains](#)..... 90
- [Modifying Admin Domain members](#)..... 92

Administrative Domain overview

Using Administrative Domains (Admin Domains or ADs), you can partition the fabric into logical groups and allocate administration of these groups to different user accounts so that these accounts manage only the Admin Domains assigned to them and do not make changes to the rest of the fabric. The ability to assign an Admin Domain to a specific user account is performed in the **User** tab of the **Switch Administration** window and not in the **Admin Domain** window.

You can create domains that are grouped together based on the type of members in the domain. For example, you can create Admin Domains based on the type of switches in your fabric using the WWN (not to be confused with the Admin Domain number) or put all the devices in a particular department in the same Admin Domain for ease of administering those devices.

You can have up to 256 Admin Domains in a fabric (254 user-defined and 2 system-defined), numbered from 0 through 255. Admin Domains are designated by a name and a number. This document refers to specific Admin Domains using the format "AD*n*" where *n* is a number between 0 and 255.

NOTE

ADs and Virtual Fabrics are mutually exclusive. Virtual Fabrics must be disabled if you want to use the AD feature.

Requirements for Admin Domains

The following are the requirements for using administrative domains:

- To manage Admin Domains, you must be a physical fabric administrator. A physical fabric administrator is a user with the Admin role and access to all Admin Domains (AD0 through AD255).
- The default zone mode setting must be set to No Access (refer to [Enabling Admin Domains](#) on page 87).

User-defined Admin Domains

AD1 through AD254 are user-defined Admin Domains. These user-defined Admin Domains can be created only by a physical fabric administrator in AD255.

System-defined Admin Domains

AD0 and AD255 are special Admin Domains and are present in every AD-capable fabric.

AD0

AD0 is a system-defined Admin Domain that, in addition to containing members you explicitly added (similar to user-defined Admin Domains), it contains all online devices, switches, and switch ports that were not assigned to any user-defined Admin Domain.

Unlike user-defined Admin Domains, AD0 has both an automatic membership list and a fixed membership list. User-defined Admin Domains have only a fixed membership list.

- Automatic membership list--Contains all devices and switches that were not assigned to any other Admin Domain.
- Fixed membership list--Contains all devices and switches that you explicitly add to AD0 and can be used to force device and switch sharing between AD0 and other Admin Domains.

The **Admin Domain** window displays the fixed members and not the automatic members, you can use the **View** menu to display a list of the automatic members.

AD0 can be managed like any user-defined Admin Domain. The only difference between AD0 and user-defined Admin Domains is the automatic membership list.

In filtered views, the automatic members of AD0 are considered direct members.

The automatic members of AD0 change dynamically as the membership of other Admin Domains changes. The fixed members of AD0 are not deleted unless you explicitly remove them.

For example, if you explicitly add DeviceA to AD0 and it is not a member of any other Admin Domain, then DeviceA is both an automatic and a fixed member of AD0. If you add DeviceA to AD2, then DeviceA is deleted from the AD0 automatic membership list, but is *not* deleted from the AD0 fixed membership list. If you then remove DeviceA from AD2, DeviceA is added back to the AD0 automatic membership list (assuming DeviceA is not in any other Admin Domains).

AD0 is useful if you want to share its zone database (called "root zone database") with a legacy fabric.

AD255 or physical fabric

AD255 is a virtual domain that contains all devices, switches, and switch ports in the fabric. AD255 presents an unfiltered view of the fabric and is also referred to as the physical fabric.

You can use AD255 to do the following:

- Manage other Admin Domains.
- Get an unfiltered view of the fabric.
- Manage ACL and distribution (this can be managed in AD0 if no other Admin Domains are present).
- Manage Advanced Performance Monitoring (this can be managed in AD0 if no other Admin Domains are present, but only if you are using Web Tools with the EGM license).

The EGM license is required only for 8 Gbps platforms, such as the:

- Brocade Encryption Switch
- Brocade 300, 5300, and 5100 switches
- Brocade VA-40FC
- Brocade 7800

For non-8 Gbps platforms, all functionalities are available without the EGM license.

You cannot manage zones with AD255, because AD255 does not have a zone database associated with it.

Admin Domain membership

Switches, ports, and devices can be members of an Admin Domain. The following Admin Domain members can be either direct or indirect members:

- Direct members--Devices, switches, and ports that you explicitly add to an Admin Domain. Direct members are listed in the Admin Domain membership list.
- Indirect port members--Ports that are implicitly added as part of an Admin Domain when any of the following occurs:
 - A device that is connected to a port was added to the Admin Domain.
 - A switch to which the port belongs is a member of the Admin Domain.
- Indirect device members--Devices that are connected to ports that are direct members of an Admin Domain.

Enabling Admin Domains

The default zone mode setting gives attached devices either All Access to all devices or No Access to all devices. To begin implementing an Admin Domain structure within a SAN, you must set the default zone mode to No Access. You must be in AD0 to change the default zone mode. After the default zone mode is set to No Access, you cannot change it from the physical fabric.

NOTE

The term "physical fabric" is used in Web Tools only.

Even though the default zone mode access is set to No Access, you can still create and enable zones within each Admin Domain. These zones are configurable only from the Admin Domain in which they were created. Indirect port members cannot be zoned.

To enable Admin Domains, perform the following steps.

1. Change the Admin Domain context to AD0. Refer to [Changing the Admin Domain context](#) on page 41.

NOTE

Changing the Admin Domain context requires using Web Tools with the EGM license; otherwise, access to this feature is denied and an error message displays. Change the Default Zone mode to No Access. Refer to [Setting the default zoning mode](#) on page 140 for more information.

2. Navigate to AD255 or the physical fabric and begin managing the Admin Domains.

Admin Domain window

You can view and manage Admin Domains through the Admin Domain window.

If you are not using Web Tools with the EGM licensed installed, managing Admin Domain operations is denied and an error message displays.

The EGM license is required only for 8 Gbps platforms, such as the:

- Brocade Encryption Switch
- Brocade 300, 5300, and 5100 switches
- Brocade VA-40FC
- Brocade 7800

For non-8 Gbps platforms, all functionalities are available without the EGM license.

The **Admin Domain** window displays information about the Admin Domains that are defined in the fabric. If you launch the **Admin Domain** window from AD255 (physical fabric), the window contains information about the current content of all Admin Domains. If you launch the **Admin Domain** window from any other Admin Domain, the window displays the current Admin Domain only.

To manage Admin Domains, you must be logged in with the role of Admin.

ATTENTION

Any changes you make in the **Admin Domain** window are held in a buffered environment and are *not saved to persistent storage until you explicitly save the changes*. If you close the **Admin Domain** window without saving your changes, your changes are lost. To save the buffered changes you make to persistent storage in the **Admin Domain** window, refer to [Saving local Admin Domain changes](#) on page 90 on page 70. When you are logged into AD0, if a physical fabric administrator modifies the AD configuration from another session, the changes in the membership might not be visible to you.

When you launch the **Admin Domain** window and select the parent **Admin Domains** node in the tree on the left pane, the **Admin Domain** window displays summary information about all of the Admin Domains. You can also select a specific Admin Domain from the tree to display detailed information about that Admin Domain. The detailed view displays summary information as well as information about the online switch, port, and device members of the selected Admin Domain.

NOTE

The tree only displays launched switches and their ports. It also displays all the devices in the fabric. Slot and port information of other switches is not displayed in the tree.

The **Admin Domain** window has the following buttons in a task bar at the top of the window:

- **New** allows you to create a new Admin Domain.
- **Print** allows you to print the current or effective configuration.
- **Refresh** allows you to refresh the information for the entire fabric or a specific Admin Domain.
- **Apply** allows you to apply a configuration.
- **Save** allows you to save a configuration.
- **Clear** allows you to clear the configuration.

You can right-click any of the table content in the **Admin Domain** window to access **Export**, **Copy**, and **Search** options. The options are not available if the table does not have any content.

NOTE

You must accept the Brocade Certificate at the beginning of the login to Web Tools to enable the functionality of **Export** and **Copy**.

- Click **Export Row** or **Export Table** to save the contents to a tab-delimited file.
- Click **Copy Row** or **Copy Table** to copy the contents in tab-delimited text format to a file.
- Click **Search** to search for a specific text string in the table.

The **Switch Members** dialog box displays.

In the **Switch Members** dialog box, enter the text string and press **Enter**. This is an incremental search and allows 24 maximum characters including the wildcards question mark (?) and asterisk (*). The first row containing the text string is highlighted. To find the next match, press the down arrow. To find the previous match, press the up arrow. If the text is not found in the table, the text turns red.

Opening the Admin Domain window

Use the **Admin Domain** window to perform all Admin Domain configuration procedures.

If you want to configure Admin Domains, you must launch the **Admin Domain** window from the physical fabric context. If you are in any Admin Domain other than the physical fabric, the module launches in read-only mode.

To open an **Admin Domain** window, perform the following steps.

1. Select a switch from the **Fabric Tree** and log in when prompted.
Switch View displays information for the selected switch.
2. If you plan to modify the Admin Domain configuration, from the **Admin Domain** menu, select **Physical Fabric**.
3. Click **Admin Domain** in the **Manage** section of the **Tasks** menu.

The **Admin Domain** window displays.

Refreshing fabric information

When you refresh, the system updates the display of fabric elements only (switches, ports, and devices). It does not update Admin Domain changes in the **Admin Domain** window.

This option allows you to refresh the fabric element information displayed at any time.

To refresh the fabric information open the **Admin Domain** window and click **Refresh**. The status for the fabric, including switches, ports, and devices is refreshed.

Refreshing Admin Domain information

Any changes you make in the **Admin Domain** window are saved to a local buffer. They are not applied to persistent storage until you invoke one of the transactional operations listed in the **Actions** menu.

You can refresh the Admin Domain information at any time to reflect changes that might have been made by other users or to back out of current, unsaved work and start again.

ATTENTION

When you refresh the buffered information in the **Admin Domain** window, any Admin Domain configuration changes you made and not yet saved are erased from the buffer and replaced with the currently enabled Admin Domain information that is saved on the switch.

To update the information in the **Admin Domain** window with the information saved on the switch, perform the following steps.

1. In the **Admin Domain** window, click the **Refresh** arrow.
2. Click **Refresh Admin Domains**.

The information in the **Admin Domain** window is updated with the saved information on the switch. This action also refreshes the fabric information as described in [Refreshing fabric information](#) on page 89 on page 70. Any unsaved Admin Domain changes are deleted.

Saving local Admin Domain changes

All information displayed and all changes made in the **Admin Domain** window are buffered until you save the changes. That means that any other user looking at the Admin Domain information for the switch does not see the changes you made until you save them.

To save the local Admin Domain changes, perform the following steps.

1. Select **Actions** > **Save AD Configuration** to save your changes to persistent storage as the defined Admin Domain configuration.
2. Select **Actions** > **Apply AD Configuration** to save your changes to persistent storage *and make your changes effective in the fabric*.

These options are not enabled until you make a change to the Admin Domain configuration.

If another user has an Admin Domain operation in progress at the time that you attempt to save changes, Web Tools displays a warning to indicate that another Admin Domain transaction is in progress on the fabric. You can select to abort the other transaction and override it with yours.

This action updates the entire contents of the **Admin Domain** window, not just the selected Admin Domain. You can save your changes at any time during the Admin Domain configuration session.

Closing the Admin Domain window

It is important to remember that any changes you make in the **Admin Domain** window are not saved automatically.

To close the Admin Domain window, perform the following steps.

1. In the **Admin Domain** window, select **File** > **Close**.
If there are changes in the buffer that were not saved, a warning message displays. Confirm that you want to close the Admin Domain session without saving the changes.
2. Click **Yes** to close without saving changes, or click **No** to go back to the **Admin Domain** window to save the changes (refer to [Saving local Admin Domain changes](#) on page 90).

Creating and populating domains

Setting up an Admin Domain involves the following steps.

1. Creating an Admin Domain.
2. Assigning one or more administrators to the Admin Domain.

The Admin account always has access to administer the Admin Domains, even if no other users are assigned (refer to [Changing user account parameters](#) on page 202).

When you create an Admin Domain, you can activate the Admin Domain after you finish creating it. If you activate the Admin Domain, you must click **Apply** to transfer your changes from the Web Tools database to the fabric database so that your changes are applied to the fabric. You can log in to an active Admin Domain. You cannot log in to an Admin Domain that was deactivated.

Creating an Admin Domain

To create an Admin Domain, perform the following steps.

1. Open the **Admin Domain** window, as described in [Opening the Admin Domain window](#) on page 89.
2. Click **New**.

The **Create Admin Domain** wizard displays.

3. In the **Name** area, assign an Admin Domain name.

You can specify a name or let the system assign the name for you.

4. In the **ID** area, assign an Admin Domain ID.

You can specify an ID or let the system assign the ID for you.

5. In the **State** area, select the **Active** check box to activate the Admin Domain when you finish creating it.

NOTE

Clear the **Active** check box if you want the Admin Domain deactivated when you finish creating it.

6. Click **Next**.
7. In the **Membership** area, assign members to the Admin Domain by selecting them in the **Available Members** section and clicking **Add**, **Add Ports**, or **Add Devices**:

- Select a switch, port, or device in the **Available Members** tree and click **Add** to add the selected element.

Alternatively, you can press the **Insert** key to add your selections.

- Select a switch or slot and click **Add Ports** to add all of the ports in the selected switch or slot.
- Select a switch, slot, or port and click **Add Devices** to add all of the devices for the selected element.

8. Optional: Click **Manual** to add offline devices.

NOTE

To add ports or other switches in the fabric, launch the **Add Member** wizard by clicking the **Manual** button.

9. Click **Next**.

The wizard displays a summary of the Admin Domain. Read the summary to verify that the Admin Domain is set up correctly.

10. Click **Finish** to close the wizard.

11. Click **Save** to save the new Admin Domain configuration to persistent storage.

12. Click **Apply** to enforce the new Admin Domain configuration as the effective configuration.

Adding ports or switches to the fabric

To add ports or switches to the fabric, perform the following steps.

1. From the **Create Admin Domain** wizard, click **Manual**.

The **Add Member** window displays.

2. Select **Port** and enter the member ID in the **Member** field using the Domain Index (D,I) format.
3. Click **Apply** to enforce the added members, and then click **OK** to accept the changes.

Activating or deactivating an Admin Domain

To activate or deactivate an Admin Domain, perform the following steps.

1. Open the **Admin Domain** window.
2. From the tree on the left, select the Admin Domain you want to activate or deactivate.
3. Click **Activate** to activate the Admin Domain, or click **Deactivate** to deactivate the Admin Domain.
4. Select **Actions** > **Save AD Configuration** to save the new Admin Domain configuration to persistent storage.
5. Select **Actions** > **Apply AD Configuration** to enforce the new Admin Domain configuration as the effective configuration.

ATTENTION

When you deactivate an Admin Domain, the members or devices assigned to the domain can no longer access its hosts or storage unless those devices are part of another Admin Domain. When you deactivate an Admin Domain, no one can use this Admin Domain to log in to a switch.

Modifying Admin Domain members

To modify members from an Admin Domain, perform the following steps.

1. Open the **Admin Domain** window.
2. From the tree on the left, select the Admin Domain you want to modify.
3. Click **Modify**.
The **Modify Admin Domain** wizard displays the Membership step.
4. Assign members to the Admin Domain by selecting them in the **Available Members** section and clicking **Add**, **Add Ports**, or **Add Devices**:
 - Select a switch, port, or device in the **Available Members** tree and click **Add** to add the selected element.
Alternatively, you can press the **Insert** key to add your selections.
 - Select a switch or slot and click **Add Ports** to add all of the ports in the selected switch or slot.
 - Select a switch, slot, or port, and click **Add Devices** to add all of the devices for the selected element.
5. Optional: Click **Manual** to add offline switches and devices.
6. Remove members from the Admin Domain by selecting them in the **Selected Members** section and clicking **Remove**.
Alternatively, you can press the **Delete** key to remove selected items.
7. Click **Next**. Use the summary to verify that the Admin Domain setup is correct.
8. Click **Finish**.
9. Select **Actions** > **Save AD Configuration** to save the new Admin Domain configuration to persistent storage.
10. Select **Actions** > **Apply AD Configuration** to enforce the new Admin Domain configuration as the effective configuration.

Renaming Admin Domains

You can change the name of an Admin Domain, including an auto-assigned ID name. The Admin Domain name cannot exceed 63 characters and can contain alphanumeric characters. The only special character allowed is an underscore (_).

NOTE

You cannot rename AD0 or AD255.

To rename an Admin Domain, perform the following steps.

1. Open the **Admin Domain** window.
2. From the tree on the left, select the Admin Domain.
3. Click **Rename**.
4. Enter the new name and click **OK**.
5. Select **Actions** > **Save AD Configuration** to save the new Admin Domain configuration to persistent storage.
6. Select **Actions** > **Apply AD Configuration** to enforce the new Admin Domain configuration as the effective configuration.

Deleting Admin Domains

When you delete an Admin Domain, its devices no longer have access to the members of the zones with which it was associated.

To delete an Admin Domain, perform the following steps.

1. Open the **Admin Domain** window.
2. From the tree on the left, select the Admin Domain.
3. Click **Delete**.
4. In the confirmation dialog box, click **Yes** to delete the domain.

The system deletes the Admin Domain.

5. Select **Actions** > **Save AD Configuration** to save the new Admin Domain configuration to persistent storage.
6. Select **Actions** > **Apply AD Configuration** to enforce the new Admin Domain configuration as the effective configuration.

Clearing the Admin Domain configuration

When you clear the Admin Domain configuration, all user-defined Admin Domains are deleted and all fabric resources (switches, ports, and devices) are returned to AD0. You cannot clear the Admin Domain configuration if zone configurations exist in any of the user-defined Admin Domains.

To clear the Admin Domain configuration, perform the following steps.

1. Open the **Admin Domain** window.
2. Select **Actions** > **Clear AD Configuration**.
3. In the confirmation dialog box, click **Yes** to clear the Admin Domain configuration.

Managing Ports

- [Port management overview](#)..... 95
- [Configuring FC ports](#)..... 99
- [Assigning a name to a port](#)..... 103
- [Port beaconing](#)..... 103
- [Enabling and disabling a port](#)..... 104
- [Persistent enabling and disabling ports](#)..... 105
- [Configuring NPIV ports](#)..... 106
- [Port activation](#)..... 106
- [Port swapping index](#)..... 110
- [Configuring port binding](#)..... 112
- [Configuring BB credits on an F_Port](#)..... 113
- [Configuring ALPA](#) 114
- [Configuring port octet speed combination](#) 115
- [Configuring CCTL](#)..... 116
- [Configuring compression and encryption](#)..... 117
- [Forward Error Correction](#)..... 119
- [In-Band Management](#)..... 119
- [GigE port modes](#)..... 120

Port management overview

This chapter describes how to manage FC and gigabit Ethernet (GbE) ports. Refer to [Viewing EX_Ports](#) on page 170 for information on how to view and configure EX_Ports.

The **Port Admin tab** is refreshed automatically every 60 seconds and is refreshed immediately when you make any port changes through Web Tools.

To manage ports, you must be logged in with the role of switchadmin, admin, basicswitchadmin, operator, or fabric admin. If you are logged in with a user, securityadmin, or zoneadmin role, you can only view the port information.

For information about creating unique user account roles, refer to [User-defined accounts](#) on page 197.

Opening the Port Admin tab

Select the **Port Admin** tab in the **Switch Explorer** window. The **Port Admin** tab displays information about the ports on the switch. Refer to [Switch View](#) on page 41 for information about accessible ports.

The **Port Admin** tab displays in **Basic** mode. To view more port management options, select **View** > **Advanced**.

NOTE

You can drag the column divider to resize a column, or drag columns to re-arrange them in a custom order. You can also right-click a column heading to resize one or all columns, or sort the information in ascending or descending order.

Admin Domain considerations

In fabrics with user-defined Admin Domains, the **Port Admin** tab is filtered to show only ports that are direct or indirect members of the currently selected Admin Domain:

- Direct members are ports that were directly added to the Admin Domain as members.
- Indirect members are:
 - Non-owned ports on a member switch
 - Non-owned ports to which member devices are attached
- All active ports, as well as any inactive EX_Ports are shown.

Port Admin tab components

The **Port Admin** tab has the following four tabs in the top left corner:

- **FC Ports** tab displays all of the FC ports on the switch (physical FC ports and logical ports).
- **VE/VEx Ports** tab displays all of the VE_Ports and VEx_Ports on the switch. If the switch does not have VE_Ports and VEx_Ports, the **VE/VEx Ports** tab does not display.
- **ICL Ports** tab displays all of the ICL ports on the switch. If the switch does not have ICL Ports, the tab does not display.
- **GigE Ports** tab displays all of the gigabit Ethernet ports. If the switch does not have gigabit Ethernet ports, the **GigE Ports** tab does not display.

The **GigE Ports** tab has the following subtabs:

- General--General information about the gigabit Ethernet ports.
- SFP--Displays information about SFP ports.
- Port Statistics--Displays statistics about the ports.
- IP Interfaces--Lets you view interfaces
- IP Routes--Lets you view routes
- Inband IP Interfaces--Lets you configure interfaces
- Inband IP Routes--Lets you configure routes
- FCIP Tunnels --Lets you view FCIP tunnels. This tab has two buttons: **Go to FCIP port** and **Show Security Policies**.

On selecting an FCIP tunnel, the following circuit details with the circuit properties are displayed:

- Circuit Number
- Tunnel ID
- Administrator Status
- Operational Status
- GigEPort
- Source IP
- Destination IP
- Gateway
- VLAN ID
- MTU Size

- DP1 GigePort
- DP1 Source IP
- DP1 Destination IP
- DP1 VLAN ID
- DP1 MTU Size
- Compression Mode
- Data L2COS Value
- DSCP Data
- IKE Policy Number
- IPsec Policy Enabled
- Keep Alive Timeout
- MaximumCommunicationRate (Mbps)
- MinimumCommunicationRate (Mbps)
- MaxRetransmitRate
- MinRetransmitRate
- Metric
- Pre-Shared key
- QOS Mapping
- Selective Ack

Ports Explorer tree

The **Ports Explorer** tree displays on the left side of the window. Items in the tree are displayed as follows:

- Switches--Switch ID, with switch name in parentheses; for example, 3(MapsSW_202)
- Blades--Slot number of the blade, with blade ID in parentheses; for example, Slot 7(24)
- Ports--Port number; for example, Port 2
- 10G SFP ports-- A yellow triangle displays to visually distinguish the 10 Gbps SFP+ ports.

Actions

The **Actions** list contains options for all the tasks you can perform on the selected ports. If you select more than one port, options are available for only the tasks that you can perform on all of the selected ports. Options are unavailable if they are not applicable to the selected ports.

Port information displays in either a table of ports or information about a specific port, depending on your selection. If you select a slot or switch, the system displays a table of all the ports for the slot or switch. If you select a port, the system displays detailed information about the port.

Subtabs

You can view either **Basic Mode** or **Advanced Mode**, and view the subtabs that contain additional information about the port. The available subtabs depend on the type of port selected.

To view basic mode, select **View** > **Basic**. When viewing detailed information about a port, **Basic Mode** provides these subtabs:

- **General** --Under this tab, the **Actions** list provides the following options:
 - Edit
 - Rename

- Enable/Disable
- Persistent Enable/Persistent Disable
- **SFP** --Physical ports only (FC, CEE, and GbE)
 - Basic information about the port equipment
- **QSFP** --Quad Small Form-factor Pluggable ports
 - Basic information about the port.
 - UnitNumber
 - ChannelIndex
 - DeviceTech
- **Port Statistics** --All ports
 - Basic port information and statistics

Note that on the **Port Statistics** subtab, you can view either absolute values or deltas for port statistics. Viewing the deltas is useful if you want to view current port trends. To reset the counters on the port statistics, click the **Clear Counters** button.

FCIP statistics for a GbE port are the accumulated statistics of all the FCIP tunnels for that GbE port.

- **IP Interfaces** --GbE ports only
- **IP Routes** --GbE ports only

To view advanced mode, select **View > Advanced** . When viewing detailed information about a port, the **Advanced Mode** provides these additional subtabs:

- **General** --Under this tab, the **Actions** list provides the following options:
 - Edit
 - Rename
 - BB Credit
 - Re-Authenticate
 - Swap
 - Reserve License
 - Release License
 - F-Port Trunking
 - Enable/Disable
 - Persistent Enable/Disable
 - Binding--Bind PID/Un-Bind PID
 - CSGlobal--Enable/Disable
 - Beacon--Enable/Disable
 - Compression--Enable/Disable
 - Encryption--Enable/Disable
 - Non DFE--Enable/Disable
 - Forward Error Correction--Enable/Disable
 - NPIV--Enable/Disable/Max Login
 - Trunking--Enable/Disable
 - QoS--Enable/Disable
 - Speed combination (applicable only to the Brocade 6520, Brocade 6510, and Brocade DCX 8510-4 and DCX 8510-8 with the FC16-32 or FC16-48)
- **SFP** --Physical ports only (FC, CEE, and GbE)
 - Basic Information about the port.
 - Advanced information about the port equipment
- **QSFP** --Quad Small Form-factor Pluggable ports

- Basic Information about the port.
- Advanced information about the port equipment.
- UnitNumber
- ChannelIndex
- DeviceTech
- MaxCaseTemp
- **Port Statistics**
 - Advanced port statistics
 - Error details
 - FCIP Tunnels--GbE ports and logical FCIP ports only (not available for the FR4-16IP).

Controllable ports

All ports have a **Controllable** attribute visible from the **Advanced Mode** , which represents the RBAC permission.

The **Controllable** attribute is **No** when non-owned E_Ports and indirect member ports on non-owned switches are accessible in read-only mode and are not controllable, regardless of RBAC permissions. Additionally, if you are logged in with read-only permission, the **Controllable** attribute displays **No** for all ports.

The **Controllable** attribute is **Yes** , if your role gives you Modify permission for ports. If a port is controllable, all configuration functionality is enabled.

Configuring FC ports

With the **FC Port Configuration** wizard, you can configure allowed port types, port speed, and long distance mode for physical ports.

You must use Web Tools with the EGM license enabled on the switch to configure long distance; otherwise, access to long distance configuration is denied and an error message displays.

The EGM license is required only for 8 Gbps platforms, such as the following:

- Brocade Encryption Switch
- Brocade 300, 5300, 5100, and 5432 switches
- Brocade VA-40FC
- Brocade 7800

For non-8 Gbps platforms, all functionality is available without the EGM license.

The following procedure describes how to open the **FC Port Configuration** wizard.

NOTE

With Fabric OS v7.0.1 and later, Web Tools supports interoperability between a Fabric OS fabric and a Brocade Network OS fabric through an FC router. You can select this interoperability mode in the **FC Port Configuration** wizard.

1. Click a port in the **Switch View** to open the **Port Admin** tab.
2. Select the **FC Ports** tab.
3. Select the port you want to configure from the tree on the left.
4. Click the **General** subtab.

NOTE

Long distance does not display from the **General** or **Table** subtabs if the EGM license is not enabled on the switch.

5. Select **Edit** from the **Actions** list.

The **FC Port Configuration** wizard displays. The fields are populated with the current configuration values.

NOTE

Long distance is not displayed from the **Edit Configuration** window. You can view long distance from the **View** tab when you display the port details.

6. Follow the steps in the wizard.
-

NOTE

If you configure a disabled port as an EX_Port, the wizard displays the **Enable Port after configuration** check box. If you select the check box, the disabled port is automatically enabled after configuration; otherwise, the port remains in the same state after configuration.

Allowed port types

For FC ports, the **Port Admin** tab displays the following values relating to port type:

Port Type	This is the actual or current port type. If the port is offline, this value is the allowed types (or U_Port, if no type constraint is specified). If the port is online, this value is the type to which the port has been configured.
Allowed Port Type	The allowed or configured port type. The allowed port types indicate any constraints on what types the port can be configured when it comes online. For normal (that is, non-EX_Port) ports, the following are the allowed port types:
L_Port	The port can be used to connect a loop device.
F_Port	The port can be used to connect a non-loop device.
E_Port	The port can be used to connect to another switch. On the Brocade FC8-64, ports 56 through 63 are not available as E_Ports. This option is unavailable for these ports.
U_Port	For a physical FC port: the port can be any one of E_Port, F_Port, or L_Port. For a logical FC port: the port can be either VE_Port or VEX_Port.

When the wizard prompts you to select allowed port types, if all of these boxes are selected, there are no constraints on port type. The port negotiated to its preferred type when the switch comes up, depending on what type of device or switch to which it is connected.

Clearing a check box guarantees that the port does not attempt to function as a port of the unchecked type. At least one type must remain selected. An FC port cannot be configured as an E_Port or L_Port.

L_Ports are not supported on the Brocade FC16-32, Brocade FC16-48, Brocade FC16-64, Brocade FC8-32E, Brocade FC8-48E, Brocade 6505, Brocade 6510, and Brocade 6520.

NOTE

To configure a port as an EX_Port, the switch must be capable of supporting FCR or FCIP features. The EX_Port option is disabled in the wizard if the switch does not meet these requirements.

Speed

The **FC Port Configuration** tab provides the option to set the port speed. To set the speed, the EGM license must be enabled on the switch. Otherwise, access to port speed configuration is denied and an error message displays. You can configure 2G, 4G, 8G, or 16G port speed or set the port to auto-negotiate the highest possible port speed. The **Auto Max** options are displayed only when you set the port speed as auto-negotiation and these options allow you to set the speed limit the port can auto-negotiate. The following **Auto Max** speed levels are supported:

- Auto Max 2G
- Auto Max 4G
- Auto Max 8G
- Auto Max 16G

NOTE

The **Auto Max 16G** option is supported for the 16G Capable FC ports only. Auto Max configuration is optional.

Long distance mode

Port long distance configurations can be performed in the **Switch Admin Extended Fabric** tab if the link is used over long distances. To configure the long-distance settings, the EGM license must be enabled on the switch. Otherwise, access to port long distance configuration feature is denied and an error message displays. For information about long-distance mode settings, refer to [Administering Extended Fabrics](#) on page 187.

The EGM license is required only for 8 Gbps platforms, such as the following:

- Encryption Switch
- 300, 5300, and 5100 switches
- Brocade VA-40FC
- Brocade 7800

For non-8 Gbps platforms, all functionality is available without the EGM license.

Ingress rate limit

From Fabric OS v7.2.0, the ingress rate limit can be configured without an Adaptive Networking (AN) license.

Ingress rate limiting restricts the speed of traffic from a particular device to the switch port, allowing latency-sensitive applications to share the storage resources alongside throughput-intensive applications. Ingress rate limiting delays the return of BB credits to the external device. By limiting the throughput on the ingress side of a port, existing congestion can be removed or avoided.

The implication is as follows:

- Ingress rate limiting is not supported if the F_Port is in AOQ.
- Ingress rate limiting is not supported if the F_Port is part of Trunk.
- Ingress rate limiting is not supported if the F_Port is not QoS-enabled, but it connects to a QoS-enabled AG switch port.

Ingress rate limiting is applicable only to F_Ports and FL_Ports and is available only on the following platforms:

- Brocade DCX
- Brocade DCX-4S
- Brocade DCX 8510-4 and Brocade DCX 8510-8
- Brocade Encryption Switch
- Brocade 300
- Brocade 5100
- Brocade 5300
- Brocade 5410
- Brocade 5424
- Brocade 5450
- Brocade 5460
- Brocade 5470
- Brocade 5480
- Brocade 6510
- Brocade 6520
- Brocade 7800
- Brocade 7840
- Brocade VA-40FC

To configure the ingress rate limit feature, perform the following steps.

1. Select **View** > **Advanced** .
2. In the **Port Admin** tab, select a port to configure.
3. Select **QoS** > **Enable** from the **Actions** list.

This enables the QoS on the selected port. The QoS status is displayed in the port table.

4. Select **Edit** from the **Actions** list.

The **Port Configuration** wizard displays.

5. Click **Next** and configure the port using the predefined **Ingress Rate Limits (Mb/s)** values.
6. Click **Next** and **Save** to save the configuration.

NOTE

You can set the ingress rate limit even if QoS is disabled. It does not take effect until QoS is enabled.

Available buffer credit calculation

The **FC Port Configuration** wizard provides non-editable **Recommended Buffer** and **Remaining Buffer** fields to check the available buffer credit for a port.

Recommended Buffer

The number of recommended buffers. The recommended buffer is calculated based on the following values:

- Speed (not based on auto-negotiate speed)
- Frame size
- Desired distance (km)

Remaining Buffer

The number of remaining buffers. If the configured port buffer exceeds the remaining buffer, then an error message displays.

Assigning a name to a port

Port names are optional. You can assign a name to an FC or FCIP port to make port grouping easier. You can also rename FC and FCIP ports. You cannot rename GbE ports. The **Port Name** column in the **General** tab displays the default port name.

Port names can be from 1 through 128 alphanumeric characters, unless FICON Management Server (FMS) mode is enabled. If FMS mode is enabled, port names should be limited from 1 through 24 alphanumeric characters. The comma (,), semicolon (;), and "at" symbol (@) are not allowed.

NOTE

Duplicate port names are not allowed in FMS mode.

To assign a name to a port, perform the following steps.

1. Click a port in the **Switch View** to open the **Port Admin** tab.
2. Select the **FC Ports** tab.
3. From the tree on the left, select the switch or slot that contains the port you want to rename.
4. From the table, select a port or multiple ports you want to rename.
5. Select **Rename** from the **Actions** list.

The **Rename** dialog box displays the selected port details.

6. Edit the names in the **Port Name** column and click **OK**.

Port beaconing

Individual FC ports can be set to beacon using the **Port Admin** tab. Port beaconing status displays in the **Port Beaconing** column. The **Switch View** reflects the port beaconing status by flashing the port amber and green for 2.5 seconds each, in an alternating pattern.

To configure beaconing for an FC port, perform the following steps.

1. Select the **Port Admin** tab.
2. Click **View > Advanced**, if the **Port Admin** tab is in **Basic** mode.
3. Select the switch in the **FC Ports Explorer** list.
4. From the table, select a port or multiple ports you want to set to beacon.
5. Select **Beacon > Enable** from the **Actions** list.

NOTE

You may select all the ports on the switch, but if you select a port that is not valid for beaconing, the **Beacon** option is disabled.

While enabling port beacon, an error message displays for the following conditions:

- If switch beacon or chassis beacon is enabled on the switch.
- If Link Cable beacon is enabled on the port.

Enabling and disabling a port

To enable or disable a port, perform the following steps.

1. Click a port in the **Switch View** to open the **Port Admin** tab.
2. Select the **FC Ports** or **GigE Ports** tab.
3. From the tree on the left, select the switch or slot that contains the port you want to enable or disable.
4. From the table, select one or more ports.

NOTE

Use **Shift + click** and **Ctrl + click** to select multiple ports. You can select multiple ports from the table. You cannot select multiple ports from the tree.

5. Select either **Enable/Disable > Enable** or **Disable** from the **Actions** list.

NOTE

If the **Enable** or **Disable** option is unavailable, the port is already in the enabled or disabled state. For example, if the **Enable** option is unavailable, the port is already enabled. If you select multiple ports in both enabled and disabled states, both options are active. When you click either option, the action is applied to all selected ports.

6. Optional: If you are accessing a Brocade 7800 switch, you can set the media type for the GE0 and GE1 gigabit Ethernet ports to either copper or optical.
 - a) Select the **GigE Ports** tab.
 - b) Select either the **GE0** or **GE1** port.
 - c) Select either **Copper** or **Optical** from the **Media Type** selection list.
7. Click **Yes** in the confirmation window.

Considerations for enabling or disabling a port

You should understand the following limitations and conditions when enabling or disabling a port:

- On FR4-18i and FC4-16IP port blades, all ports are disabled by default. You can disable and re-enable them as needed.
- If a port is not licensed you cannot enable it until you install the appropriate license, such as a Ports on Demand or N_Port ID Virtualization license (refer to [Port activation](#) on page 106 for more information). The **Licensed** field located in the **General** tab in the **Port Admin** tab indicates whether a port is licensed.
- If you disable a principal ISL port (an ISL port that is designated by the fabric to be a part of the path to communicate with the principal switch), the fabric automatically reconfigures.
- If you disable a port that was connected to a device, that device is no longer accessible from the fabric. For more information, refer to the *Fabric OS Administrator's Guide*.

Persistent enabling and disabling ports

To enable or disable a port so that it remains enabled or disabled across switch restarts, perform the following steps.

NOTE

Ports cannot be persistently enabled or disabled when FMS is enabled.

1. Select a port in the **Switch View** to open the **Port Admin** tab.
2. Select the **FC Ports**, **VE/VEx Ports**, **ICL Ports**, or **GigE Ports** tab.
3. From the tree on the left, select the switch or slot that contains the port.
4. From the table, select one or more ports.

NOTE

Use **Shift** + click and **Ctrl** + click to select multiple ports. You can select multiple ports from the table. You cannot select multiple ports from the tree.

5. Select either **Persistent Enable/Disable** > **Enable** or **Disable** from the **Actions** list.

NOTE

Persistent enable or disable is not supported in FMS mode.

NOTE

If the **Enable** or **Disable** option is unavailable, the port is already in that state or FMS mode is enabled on the switch. For example, if the **Enable** option is unavailable, the port is already enabled. If you select multiple ports in both enabled and disabled states, both options are active. When you click either option, the action is applied to all selected ports.

6. Optional: If you are accessing a Brocade 7800 switch, you can set the media type for the GE0 and GE1 gigabit Ethernet ports to either copper or optical.
 - a) Select the **GigE Ports** tab.
 - b) Select either the **GE0** or **GE1** port.
 - c) Select either **Copper** or **Optical** from the **Media Type** selection list.
7. Click **Yes** in the confirmation window.

Configuring NPIV ports

For detailed information about understanding and configuring NPIV ports, refer to the *Fabric OS Administrator's Guide*.

NOTE

The NPIV feature cannot be disabled when Access Gateway mode is enabled.

The **NPIV Max Login Limit** option configures the maximum number of permitted logins per NPIV port. Each NPIV port can support up to 255 logins. The range of valid values is from 1 through 255 logins per port. The default value is 126 logins.

The NPIV feature supports virtual switches, but not on physical switches. Each port can have a different NPIV login limit value in each logical switch. The NPIV Max Login column displays the value assigned to each port.

To configure an NPIV port, perform the following steps.

1. Select the **Port Admin** tab.
2. Select **View > Advanced**.
3. Select the **FC Ports** tab.
4. From the tree on the left, select the switch or slot.
5. From the table, select one or more logical ports.
6. Select **NPIV > Max Login** from the **Actions** list.
The **NPIV Max Login** dialog box displays.
7. Enter the number of logins to be allowed in the **NPIV Max Login** field.
8. Select a port or ports under **Selected Ports**.
9. Click the right arrow to set the maximum login limit for the selected ports and click **OK**.

Port activation

Brocade switches come with a preset number of ports enabled. Additional ports can be enabled using the Ports on Demand (POD) licenses and the Dynamic Ports on Demand (DPOD) feature (for supported switches only).

Ports on Demand is ready to be unlocked in the switch firmware. The license might be part of the licensed paperpack supplied with the switch software, or you can purchase the license separately from your switch vendor, who will provide you with a key to unlock it. You can install up to two Ports on Demand licenses on each switch.

The following table lists the ports that are enabled by default settings and the ports that can be enabled after you install the first and second Ports on Demand licenses for each switch type, and the ports that can be enabled with the Dynamic Ports on Demand feature.

TABLE 12 Ports enabled with POD licenses and DPOD feature

Switch name	Enabled by default	Enabled with Ports on Demand licenses	Enabled with the Dynamic Ports on Demand feature
Brocade Encryption	0-15	Not supported	Not supported

TABLE 12 Ports enabled with POD licenses and DPOD feature (Continued)

Switch name	Enabled by default	Enabled with Ports on Demand licenses	Enabled with the Dynamic Ports on Demand feature
Brocade 6505	0-11	12-23	
Brocade 6510	0-23	24-35, 36-47	
Brocade 6520	0-47	48-71, 72-95	
Brocade VA-40FC	0-23	24-31, 32-39	Not supported
Brocade NC-5480	1-8, 17-20	0, 9-16, 21-23	
Brocade 5480	1-8, 17-20	0, 9-12, 13-16, 21-23	Any available ports
Brocade 5470	0-7, 15, 16	8-14, 17-19	
Brocade 5460	0-3, 6-13	4, 5, 14-25	
Brocade 5450	1-10, 19-22	0, 11-18, 23-25	
Brocade 5424	1-8, 17-20	0, 9-16, 21-23	Any available ports
Brocade 5300	0-47	48-63, 64-79	Not supported
Brocade 5100	0-23	24-31, 32-39	Not supported
Brocade 5000, Brocade 4100	0-15	16-23, 24-31	Not supported
Brocade 4900	0-31	32-47, 48-63	Not supported
Brocade 4424	1-8, 17-20	0, 9-16, 21-23	
Brocade 4024	1-8, 17-20	9-12, 13-16, 21-23	Any available ports
Brocade 4020	0-7, 15, 16	8, 9, 17-19, 10-14	Any available ports
Brocade 4018	0-11	12-17	Any available ports
Brocade 4016	0-7, 10-13	8, 9, 14, 15	Any available ports
Brocade 300	0-7	8-15, 16-23	Not supported

When using the Brocade 4016, 4018, 4020, 4024, 4424, 5424, 5450, 5460, 5470, 5480, 6505, 6510, 6520, and NC-5480 switches, you can enable the Dynamic Ports on Demand (DPOD) feature, which allows you to select the ports to be enabled (instead of predefined sets of ports) after the POD license is installed. Web Tools allows you only to enable or disable the DPOD functionality on a port. To configure DPOD, refer to the *Fabric OS Administrator's Guide*.

In the **Port Admin** tab, the **Licensed** attribute for a port indicates whether a port is licensed (yes), whether it can be licensed (possible) because there are free licenses available (only applicable with the Dynamic Ports on Demand feature), or whether it is not licensed and cannot be licensed because there is no available license.

After the license keys are installed, you must enable the ports. You can do so without disrupting switch operation, as described in [Enabling and disabling a port](#) on page 104. Alternatively, you can disable and re-enable the switch to activate all ports as described in [Enabling and disabling a switch](#) on page 58.

To unlock a Ports on Demand license, you can use the supplied license key or generate a license key. For information on generating a license key, refer to *Fabric OS Software Licensing Guide*.

Enabling Ports on Demand

To enable Ports on Demand, perform the following steps.

1. Install the Brocade Ports on Demand licensed product. For instructions, refer to [Enabling Ports on Demand](#).
2. Enable the ports as described in [Enabling and disabling a port](#) on page 104.

If you remove a Ports on Demand license, the licensed ports are disabled after the next platform restart or the next port deactivation.

Enabling Dynamic Ports on Demand

You must be logged in as Admin to enable the Dynamic Ports on Demand feature.

NOTE

The Dynamic Ports on Demand feature is supported on the Brocade 4018, 4020, 4024, 5460, and 5470 switches only. If you click the **Enable DPOD** button on an unsupported switch, an error message displays.

To enable Dynamic Ports on Demand, perform the following steps.

1. Select a port in the **Switch View** to open the **Port Admin** tab.
2. Select the **FC Ports** tab.
3. From the tree on the left, select the switch or the slot that contain the ports.
4. Click **Enable DPOD** to enable the licensing mechanism to be dynamic. If the button is labeled **Disable DPOD**, the licensing mechanism is already set to dynamic.

The existing POD associations and assignments are set as the initial Dynamic POD associations.

Two fields are displayed:

- **Available Licenses** indicate the number of free licenses. These can be allocated for any port.
- **Total Licenses** indicate the total number of licenses.

Disabling Dynamic Ports on Demand

NOTE

Disabling DPOD causes traffic disruption. Any prior port associations and assignments are lost the next time the switch is restarted.

To disable the Dynamic Ports on Demand feature, log in and perform the following steps.

1. Select a port in the **Switch View** to open the **Port Admin** tab.
2. Select the **FC Ports** or **GigE Ports** tab.

3. From the tree on the left, select the switch or the slot that contain the ports.
4. Click **Disable DPOD** to set the licensing mechanism to static. If the button is labeled **Enable DPOD**, the licensing mechanism is already set to static.

Diagnostic ports

Diagnostic ports (D_Ports) are used for running diagnostics to isolate link level faults and inter-switch link testing in fabric, optical, and remote loopback modes. The D_Port is not part of any fabric and it does not carry any data or protocol traffic with it. It is used only for running diagnostic traffic for isolating link level faults. The D_Port can be used to get estimated link distance measurements as done for long distance mode links. For information on configuring a D_Port, refer to the *Fabric OS Administrator's Guide*. Web Tools cannot configure a D_Port.

The following list of features is not supported when a port is configured as a D_Port:

- Port swap
- Port bind
- Port trunk
- QoS Enable/Disable
- BB credit
- NPIV Enable/Disable/Max login
- Allow/Prohibit Matrix

D_Ports do not take part in zoning. If a D_Port is added to a zone it does not take part in the fabric.

Reserving and releasing licenses on a port basis

NOTE

If the Admin Domains feature is enabled, the Dynamic Ports on Demand configuration is only applied to the ports if the switch is a member of the current Admin Domain. The Dynamic Ports on Demand feature is supported on the Brocade 4016, 4018, 4020, 4424, 5424, 5450, 5460, 5470, 5480, 6505, 6510, 6520, and NC-5480 switches.

To reserve and release licenses on a port basis, perform the following steps.

1. Click a port in the **Switch View** to open the **Port Admin** tab .
2. Click the **FC Ports** tab.
3. From the tree on the left, click the switch or the slot that contains the port.

The **Licensed** column identifies the port license status:

- If the port has a license allocated, the **Licensed** field contains the value **Yes**.
- If the port does not have a license allocated and there are no free licenses that can be allocated, the **Licensed** field contains the value **No**.
- If the port does not have a license allocated and there are licenses that can be allocated to the port, the **Licensed** field contains the value **Possible**.

You can reserve or release a license on any port with a license allocated. You must be logged in as Admin to reserve and release licenses.

NOTE

You must disable the port or switch before reserving or releasing a license.

To reserve a license, click **Reserve License** in the **Port Admin** tab.

To release a license, click **Release License** in the **Port Admin** tab.

Port swapping index

If a port malfunctions, or if you want to connect to different devices without having to rewire your infrastructure, you can move traffic from one port to another (swap ports) without changing the I/O Configuration Data Set (IOCDS) on the mainframe computer.

NOTE

Port swapping is not applicable to GE or ICL ports because there are no areas assigned to these ports.

The following restrictions apply to all ports:

- Ports can be swapped only once.
- A swapped port can only be un-swapped.
- Port binding is not supported on swapped ports.
- The swapped ports cannot be moved to other logical switches.
- The logical switch addressing mode cannot be changed if the logical switch contains the swapped ports.

Port swapping

In the Port Admin list view and detailed view, swapped ports are indicated with the "(Swapped)" label appended to the **Port Index** column and field as shown in the following figure.

FIGURE 14 Port swapped label

Port#	Port Index
0(0x0)	0(0x0)
1(0x1)	4(0x4) (Swapped)
2(0x2)	3(0x3) (Swapped)
3(0x3)	2(0x2) (Swapped)
4(0x4)	1(0x1) (Swapped)
5(0x5)	7(0x7) (Swapped)
6(0x6)	6(0x6)

To swap ports, perform the following steps.

1. Select a port in the **Switch View** to open the **Port Admin** tab.
2. Select the **FC Ports** tab.
3. Select **View > Advanced**.
4. From the tree on the left, select the port you want to swap.
5. Select **Enable/Disable > Disable** from the **Actions** list.

You must disable the ports used for port swapping. If the port is not in the disabled state, the port swap operation internally disables and re-enables the port.

6. Select **Swap** from the **Actions** list.

NOTE

When the **Port Swap** dialog box is launched for a swapped port, the dialog box displays "The Selected port is already Swapped".

7. Enter the number of the port with which you want to swap the current port.

If the port is on a blade, you must also provide the slot number.

NOTE

Port swapping on an FC8-48, FC8-48E, FC8-64, and FC16-48 is supported only on ports 0 through 15.

8. Click **OK**.

Determining if a port index was swapped with another switch port

To determine whether a port was swapped, perform the following steps.

1. Select a port in the **Switch View** to open the **Port Admin** tab.
2. Select the **FC Ports** tab.
3. Select **View > Advanced**.
4. From the tree on the left, select the port you want to swap.
5. Click the **General** tab.

NOTE

The **Port Index** attribute on the **General** tab indicates whether a port was swapped. For ports that were swapped, the attribute name displays as Port Index value (*Swapped*), as shown in the following figure. The value indicates with which port index the port was swapped.

FIGURE 15 Port swapping index

General	
Port Number	1(0x1)
Port Name	port1
Port WWN	20:01:00:05:33:7a:4e:84
Port Media	sw
Port Type	U-Port
Bound Status	No
Port protocol	FC
Allowed Port Type	E-Port,F-Port
Speed (Gb/s)	N16
Speed Configured	Auto-Negotiate
Ingress Rate Limit (Gb/s)	Not Initialized
QoS Status	Enabled
CSCTL Mode	Disabled
Long Distance Mode	L0:Normal
Desired Distance (km)	N/A
Port Status	Disabled
Health	Offline
Additional Port Info	
Controllable	Yes
Licensed	Yes
Port Index	0(0x0) (Swapped)
Trunking	Enabled

Configuring port binding

To bind a port or ports, perform the following steps.

1. Select a port in the **Switch View** to open the **Port Admin** tab.
2. Select the **FC Ports** tab.
3. Select **View > Advanced**.
4. From the table, select the port or ports you want to bind.
5. Select **Binding > Bind PID** from the **Actions** list.

NOTE

If a port is already bound, a warning message is displayed that the port ID is already bound. The bound port is not listed in the **Bind PID** dialog box.

6. Enter the middle byte to be set in the **Start Address** field.
7. Select the ports under **Selected Ports** for which you want to set the middle bytes and click the right arrow as shown in the following figure.

For the selected ports, the middle bytes are assigned sequentially.

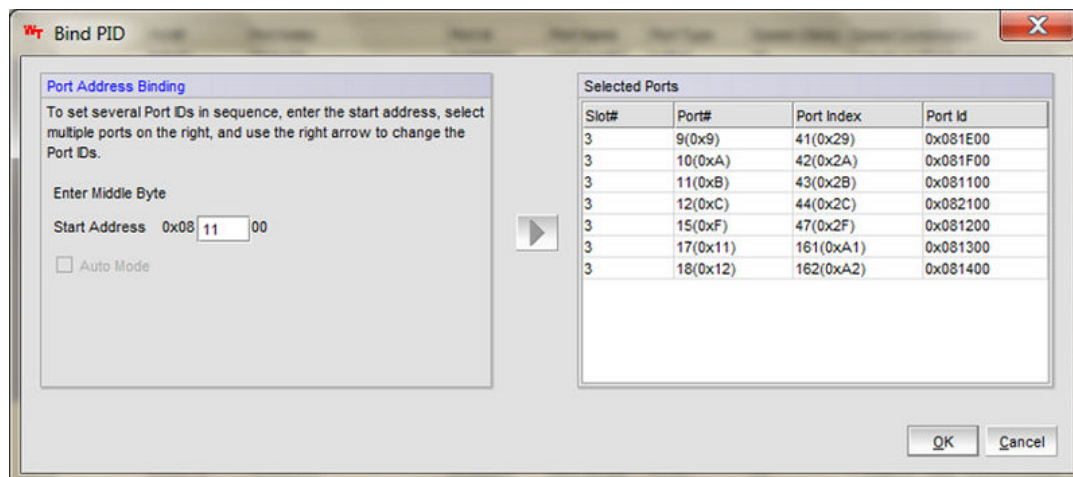
FIGURE 16 Port address binding

8. Click **OK**.

In the port list table, for the bound ports, the Port ID column displays as Port ID value (*Bound*). You can also check the **Bound Status** attribute on the **General** tab to know if a port is bound or not.

Unbinding a port

To unbind a port or ports, perform the following steps.

1. Select a port in the **Switch View** to open the **Port Admin** tab.
2. Select the **FC Ports** tab.
3. Select **View > Advanced**.
4. From the FC Ports table, select the port or ports you want to unbind.
5. Select **Binding > Un-Bind PID** from the **Actions** list.

For ports that are already bound, a warning message is displayed that the ports are already bound.

Configuring BB credits on an F_Port

You can configure the BB credits value on an F_Port. Perform the following steps.

1. Select a port in the **Switch View** to open the **Port Admin** tab.
2. Select the **FC Ports** tab.
3. Select **View > Advanced**.
4. From the tree on the left, select the switch or slot.
5. From the table, select one or more ports for which you want to set the BB credit.
6. Select **BB Credit** from the **Actions** list.

The **BB Credit** dialog box displays.

7. Enter the BB credit value in the **Enter BB Credit** field (the default value is 8).

NOTE

BB credit is not applicable for VE and ICL ports.

8. Select a port or ports under **Selected Ports**.
9. Click the right arrow to set the BB credit value for the selected ports and click **OK**.

The value displays in the table of the **Port Admin** tab. If no value is configured, the **F-Port BB Credit** column displays the default value.

Configuring ALPA

PID is the address assigned to the host when it performs a login with a fabric. The 24 bits of the PID are built from three 1-byte fields. The most significant byte is the Domain ID, the second byte is the Area which that device belongs to, and the least significant byte is the ALPA.

Persistent ALPA provides the hosts with the same ALPA that they received the first time they logged in. If they log in using the same port, the domain and the area for that device are still the same. This ensures that whenever a host logs in using the same port, it receives the same PID. The hosts can select their ALPA and the switch provides the same value, if it is available.

By default, persistent ALPA is disabled on Access Gateway switches. Access Gateway always tries to request the same ALPA which the host has requested to the edge switch, but there is a possibility that the ALPA value has already been taken by another host. Therefore, the device can either use a different ALPA value (FLEXIBLE ALPA) which is available or can stick to the same requested ALPA value (STRINGENT ALPA). As the Access Gateway controls the assignment of ALPA values to the devices, it knows which ALPA value has been taken and which is free. With the FLEXIBLE ALPA option, the host login is accepted with either the requested ALPA value or a different ALPA value. With STRINGENT ALPA, if the requested ALPA value is not available, the login is rejected.

The Enable/Disable of Persistent ALPA feature is available on the **Switch** tab of the **Switch Admin** dialog box. The Persistent ALPA tables start populating as soon as the Access Gateway boots and the devices start logging in.

NOTE

Persistent ALPA is supported on all the Access Gateway platforms, except the Brocade Encryption Switch. Persistent ALPA is not supported in non-Brocade fabrics.

To configure Persistent ALPA, perform the following steps.

1. Select **Configure** > **Switch Admin** > **Switch** tab.
2. Select **Enable** for **Persistent ALPA Mode**.
 - This enables the **Stringent ALPA** and **Flexible ALPA** options.
3. Select either **Stringent ALPA** or **Flexible ALPA**.
4. Click **Apply**.
5. Close the **Switch** page.
6. Select **Port Admin** tab.
7. Select an F_Port or U_Port from the device tree or Port List table.
8. Select **ALPA Map** from the **Actions** list.

The **Port WWN Map** dialog box launches listing the Port WWN to ALPA Map with the host. The Port WWN map automatically populates.

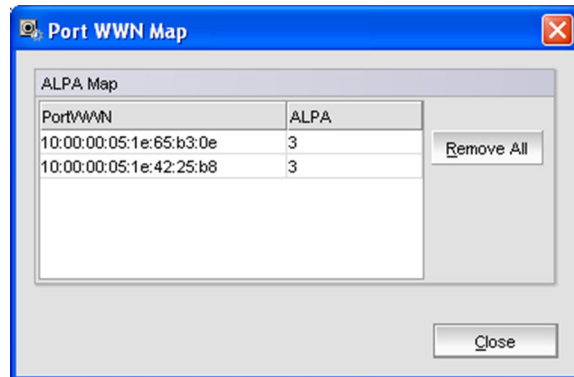
FIGURE 17 Port WWN Map dialog box

9. Optional: Click **Remove All** to clear all of the Port WWN maps.

Configuring port octet speed combination

The **Port Admin** tab provides an option to set the port octet speed combination. This option is available only on the following platforms:

- Brocade DCX 8510-8 and DCX 8510-4 with the FC8-32E, FC8-48E, FC16-32, and FC16-48 port blades
- Brocade 6510
- Brocade 6520

The ports on these hardware models are segregated into 8-port octets. The port octet speed combination is applied to the eight ports to which the selected port belongs. Based on this port octet speed combination, the speed options will be available in the **Port Configuration** wizard.

TABLE 13 Port octet speed combinations

Port octet in combination	Available port speeds within the octet
1	Auto or Fixed 16G 8G 4G 2G
2	Auto or Fixed 10G 8G 4G 2G
3	Auto or Fixed 16G 10G

NOTE

For FC8-32E and FC8-48E port blades, the port octet speed combination is Auto or Fixed 8G|4G|2G.

You can change the octet combination of a blade or switch. The octet speed must be set consistently across all members of the port octet.

NOTE

Changing from one combination to another is a disruptive operation. It may cause connected ports to become No_Sync. The 10 GE license is required in order to set a port to 10 Gbps speed.

To configure the port octet speed combination, perform the following steps.

1. Select the **Port Admin** tab.
2. Select **View > Advanced** mode.
3. Select the **FC Ports** tab.
4. In the **FC Ports Explorer** dialog box, select a port to configure.

FIGURE 18 FC Ports Explorer dialog box

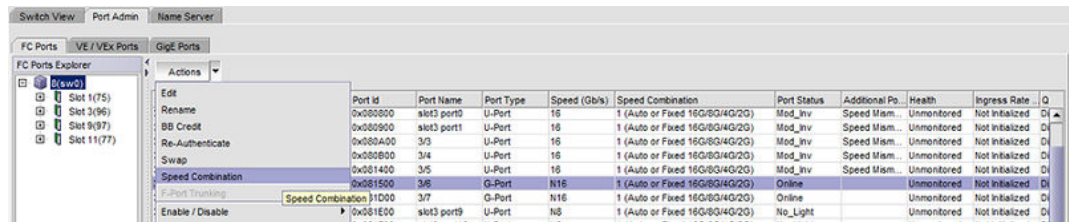

5. Select **Speed Combination** from the **Actions** list.
- The **Port Octet Speed Combination** dialog box displays.

FIGURE 19 Port Octet Speed Combination dialog box

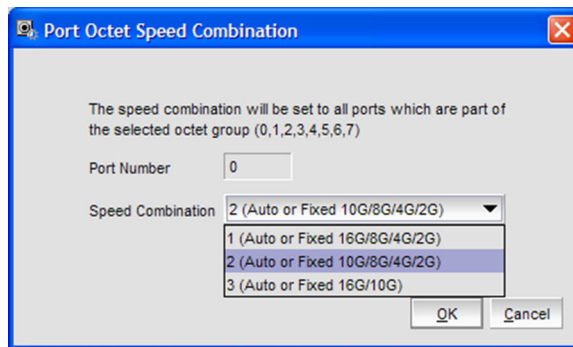

6. Select a speed combination and click **OK**.

Configuring CSCTL

Unlike the QoS Zone-based FC flow prioritization method, CSCTL enables the same SID/DID pair exchange frames with different priorities.

To be able to prioritize a frame flow between two end nodes, Fabric OS v7.0.0 and later provide support for up to 32 virtual channels (VCs) per port. This categorizes the frames entering into a fabric on the basis of preset behavior defined with these VCs, and conserves the frame's behavior until it is transmitted out of fabric. However, out of the 32 VCs for each external port, only 16 are used.

With the CSCTL method of prioritization, there is no need to have explicit traffic segregation, such as QOS_H, QOS_M, and QOS_L. The classification is entirely based upon the CSCTL database programmed into the ASIC. As the name suggests, CSCTL bits in each frame are used to define the VC number on the transmit port.

In order to achieve this kind of classification, Fabric OS v7.0.0 and later provides a CSCTL database table on each chip, capable of storing 256 entries. Each entry in the database table is populated with a

VC number which, if this feature is enabled, is retrieved by indexing the CSCTL value into the table for each frame entering the fabric.

Irrespective of the type of frame classification method used, the flow priority of a frame is primarily determined by the VC number used to transmit the frames across the ISL ports. In both methods of classification, the VC number for a frame is determined at the ingress Fabric port (F_Port) or Fabric Loop port (FL_Port), when the frame enters the fabric for the very first time. To maintain the same flow priority for a frame across all the ISL hops in a fabric, the same VC number is used while transmitting the frame at the egress E_Port until it is out of the fabric thru an F_Port or FL_Port. The main difference between the QoS zone method of classification and the CSCTL VC-based method of classification is how the VC number is computed when the frame enters into the fabric thru an F_Port or FL_Port port and, of course, the manner of setting up these two frame classification methods.

Once the CSCTL mode is enabled on an F_Port or FL_Port in a switch, the CSCTL value in the frame header of all the incoming frames on that F_Port or FL_Port is used to index into the ASIC's CSCTL database table to compute the VC number, which will define the frame's flow priority throughout its life in the fabric until it exits out of the fabric thru another F_Port or FL_Port. The QoS links (ISLs) preserve this classification during the frame's traversal across all the hops in the fabric.

NOTE

When CSCTL mode and QoS zones are enabled, QoS zones lose priority to CSCTL mode.

Enabling CSCTL mode

1. Select the **Port Admin** tab.
2. Select **View > Advanced** mode.
3. Select a port or ports to configure.
4. Select **CSCTL > Enable** from the **Actions** list.

Disabling CSCTL mode

1. Select the **Port Admin** tab.
2. Select **View > Advanced** mode.
3. Select a port or ports to configure.
4. Select **CSCTL > Disable** from the **Actions** list.

Configuring compression and encryption

Encryption provides security for the frames while they are in-flight and compression allows better bandwidth utilization over long distance. Total bandwidth supported per blade for encryption is 32 Gbps and compression is 64 Gbps. For a pizza box switch, total bandwidth for encryption and/or compression is 32 Gbps.

NOTE

Compression and Encryption feature is supported only on 16 Gbps-capable FC platforms and it is not supported in Access Gateway mode.

Enabling or disabling encryption

To configure encryption for an FC port, perform the following steps.

1. Click **Configure** > **Switch Admin**.
2. Select the **Security Policies** tab and then **Authentication** from the left panel.
3. Select **Active** or **On** from the **Switch Authentication Policy Mode** list.

NOTE

For enabling or disabling encryption on a port, the following criteria must be satisfied.

- The switch authentication policy should be active or on.
- **DH Group** must be set to **0, 1, 2, 3, 4** or **4 (2048 bit key)**.

-
4. Click **Apply** and **Close**.
 5. Select the **Port Admin** tab from the **Switch Explorer** window.
 6. Select **View** > **Advanced**.
 7. Select a port from the **FC Ports Explorer**.
 8. Select **Encryption** > **Enable** or **Disable** from the **Actions** list.

One of the following encryption statuses is displayed in the **General** tab of the port:

- **Enabled (Active)** - Encryption is enabled on a port and the configuration is Active.
- **Enabled (Inactive)** - Encryption is enabled on a port and the configuration is Inactive.
- **Disabled** - Encryption is not enabled on a port.

Enabling or disabling compression

To configure compression for an FC port, perform the following steps.

1. Select the **Port Admin** tab from the **Switch Explorer** window.
2. Select **View** > **Advanced**.
3. Select a port from the **FC Ports Explorer**.
4. Select **Compression** > **Enable** or **Disable** from the **Actions** list.

One of the following compression statuses is displayed in the **General** tab of the port:

- **Enabled (Active)** - Compression is enabled on a port and the configuration is Active.
- **Enabled (Inactive)** - Compression is enabled on a port and the configuration is Inactive.
- **Disabled** - Compression is not enabled on a port.

Displaying compression ratio

16 Gbps capable FC platforms that support compression and encryption, also provide the compression ratio. Under the **Port Admin** tab, the **FC Ports** tab, and the **General** tab of a port, display one of the following values for the **Compression Ratio**.

<<numeric value>>	Compression is enabled for a port.
--	Compression is supported but not configured.

N/A

Compression is not supported.

Forward Error Correction

Forward Error Correction (FEC) allows recovering of error bits in a 10 Gbps or a 16 Gbps data stream. This feature is enabled by default on all ISLs and ICLs of 10 Gbps and 16 Gbps FC platforms. FEC is supported in Access Gateway mode.

To configure FEC for an FC port or ICL port, perform the following steps.

1. Select the **Port Admin** tab from the **Switch Explorer** window.
2. Select **View > Advanced**.
3. Select a port from the **FC Ports Explorer** or **ICL Ports Explorer**.
4. Select **Forward Error Correction > Enable** or **Disable** from the **Actions** list.

One of the following FEC statuses is displayed in the **General** tab of the FC port or ICL port:

- **Enabled (Active)** - FEC is enabled on a port and the configuration is Active.
 - **Enabled (Inactive)** - FEC is enabled on a port and the configuration is Inactive.
 - **Disabled** - FEC is not enabled on a port.
 - **NA** - FEC is not supported.
5. Click **OK** on the warning message that prompts enabling or disabling of Forward Error Connection results in traffic disruption.

In-Band Management

In-Band Management is designed to allow the management of the switch through gigabit Ethernet ports. This allows a management station located on the WAN side of the FCIP platform to communicate with the control processor for management tasks, such as launching Web Tools, SNMP polling, SNMP traps, trouble shooting, and configuration. To provide this communication, new interfaces have been added to the control processor that have an external IP address, allowing IP connectivity through the port processor to the control processor.

The In-Band Management interface is protocol-independent, so any traffic destined for these In-Band Management interfaces is passed through the distribution point to the control processor. It is then handled on the control processor, according to the rules set forth for the normal management interface and following any security rules that may be in place on the control processor.

To provide redundancy, there is one In-Band Management interface per gigabit Ethernet port. This allows the management station on the WAN side of the network to have multiple addresses with which to reach that switch, and allow redundancy in the event one of the gigabit Ethernet ports becomes unreachable for any reason.

Communication is handled through external addresses that are configured independently for each In-Band Management interface. The In-Band Management interfaces share the routing table on the control processor. This is separate from the routing table for each gigabit Ethernet port that exists. Because of this, there are certain limits to the addresses that are allowed, and the routes that are allowed for the In-Band Management interfaces and route entries.

In-Band Management is supported on the Brocade 7800 and Brocade FX8-24. In-Band Management is not supported in Fabric OS v7.3.0. Only one IP interface entry can be configured per gigabit Ethernet port.

To configure In-Band Management, perform the following steps.

1. Select **Port Admin** > **GigE Ports** > **In-Band IP Interface**.
2. Click **Add** to configure a new In-Band Management entry.
3. Set the **IP Address Type** to **IPv4**.
4. Set the address options:
 - IP Address
 - Subnet Mask
 - MTU Size
5. Click **OK**.
6. Select the **Inband IP Routes** tab.
7. Click **Add** to configure a new route entry.

You can create a maximum of 32 In-band IP route entries.
8. Set the **IP Address Type** to either **IPv4** or **IPv6**.
9. Set the address options of the management station on the WAN side of the FCIP platform:
 - Destination IP Address
 - Subnet Mask
 - Gateway IP Address
10. Click **OK**.
11. Select the **General** subtab.
12. Select the **Enable** option from the **Inband** selection list to activate In-Band Management.

GigE port modes

Web Tools allows you to set the GigE port mode for the FX8-24 extension blades to 1 Gbps, 10 Gbps, or dual modes.

To configure the GigE port mode, perform the following steps.

NOTE

You must install the FX8-24 extension blade in a slot containing a 10 GE license to configure the mode.

1. Select **Port Admin** > **GigE Ports**.
2. Select **View** > **Advanced**.
3. Select a slot from the **GigE Ports Explorer** panel.
4. Select one of the following modes from **Mode** under the **Actions** list.
 - **1G** - To enable ge0 through ge9 ports.
 - **10G** - To enable xge0 and xge1 ports.
 - **Dual** - To enable ge0 through ge09 and xge0 ports.
5. Click **Yes** on the confirmation dialog box.

Enabling ISL Trunking

- [ISL Trunking overview](#)..... 121
- [Disabling or enabling ISL Trunking](#) 121
- [Viewing trunk group information](#)..... 122
- [F_Port trunk groups](#)..... 123

ISL Trunking overview

Inter-Switch Link (ISL) Trunking optimizes network performance by forming trunking groups that can distribute traffic between switches across a shared bandwidth.

A trunking license is required on each switch that participates in the trunk. For details on obtaining and installing licensed features, refer to [Licensed feature management](#) on page 67. For additional information about ISL Trunking, refer to the *Fabric OS Administrator's Guide*.

You must use Web Tools with the EGM license to create ISL trunk groups and to manage F_Port trunks.

The EGM license is required only for 8 Gbps platforms, such as the following:

- Brocade Encryption Switch
- Brocade 300, 5300, and 5100 switches
- Brocade VA-40FC
- Brocade 7800

For non-8 Gbps platforms, all functionality is available without the EGM license.

For detailed information about ISL Trunking configurations and criteria, refer to the *Fabric OS Administrator's Guide*.

Disabling or enabling ISL Trunking

The trunking feature requires using Web Tools with the EGM license. If you attempt to use this feature without the EGM license, an error message displays.

When the trunking license is activated, trunks are automatically established on eligible ISLs and trunking capability is enabled by default on all ports. Trunking is not supported on logical ports or GbE ports.

To disable trunking on a port, or to re-enable trunking if it has been disabled, perform the following steps.

1. Select a port in the **Switch View** to open the **Port Admin** tab.
2. Select the **FC Ports** tab.
3. From the tree on the left, select the switch name or slot name.
4. From the table, select the port that you want to trunk.

You can select multiple ports from the table. You cannot select multiple ports from the tree.

5. Select **View > Advanced** .
6. Select **Trunking > Enable** or **Disable** from the **Actions** list.
If the option is unavailable, then the selected port is already in that state.
7. Click **Yes** in the confirmation dialog box.

Admin Domain considerations

You can only enable and disable trunking for a port when the current Admin Domain owns the switch. You can log in to a switch that is not in your Admin Domain, but most of the functionality is unavailable. F_Port trunking should not be configured in physical fabric mode.

Viewing trunk group information

Use the **Trunking** tab on the **Switch Administration** window to view trunk group information.

FIGURE 20 Trunking tab

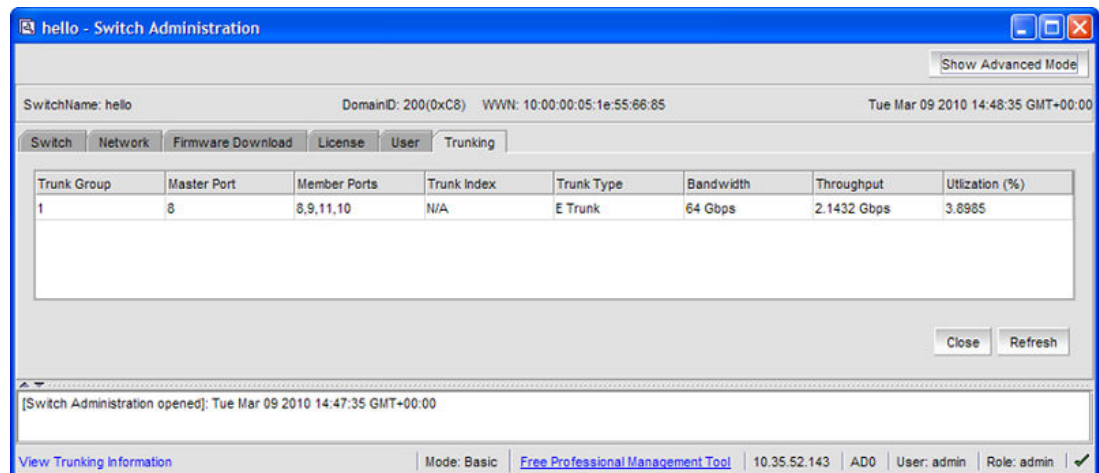

The following trunking attributes can be displayed from the **Switch Admin** view:

- Trunk port state, either master or slave
- Trunk master port
- Trunk index (applies only to F_Port trunking)
- Trunk type
- Bandwidth (shown only for E_Port, EX_Port, F_Port, and N_Port)
- Throughput (shown only for E_Port, EX_Port, F_Port, and N_Port)
- Utilization (shown only for E_Port, EX_Port, F_Port, and N_Port)

Additionally, the following trunking attributes can also be displayed from the **Port Admin** tab in **Advanced** mode:

- Trunk port state, either master or slave
- Master Port
- Trunk Index (applies only to F_Port trunking)
- Trunking Enabled

F_Port trunk groups

F_Port trunking provides extra bandwidth and robust connectivity for hosts and targets connected by switches in Access Gateway mode. There are five general criteria for establishing F_Port trunking:

- The F_Port trunking feature requires installing the EGM license; otherwise, if you attempt to use this feature in Web Tools without the license, an error message displays.
- Trunking must be enabled on the ports.
- The trunking license must be enabled on the switch in Access Gateway mode.
- The ports should not be configured for long-distance connections.
- The ports should not be port-swapped.

When you create an F_Port trunk, you create a logical entity called a trunk index (TI), which represents the physical ports. The TI represents all ports in the trunk. If a master port fails, and a slave port takes over, the TI remains the same.

The EGM license is required only for 8 Gbps platforms, such as the following:

- Brocade Encryption Switch
- Brocade 300, 5300, and 5100 switches
- Brocade VA-40FC
- Brocade 7800

For non-8 Gbps platforms, all functionality is available without the EGM license.

Creating and maintaining F_Port trunk groups

The FS8-18 Encryption blade provides trunk groups with a maximum of eight ports per trunk group. The trunk groups are in the blade port ranges 0-7 and 8-15, which are applicable to front-end ports. On the Brocade Encryption Switch, the trunk groups are in the port ranges 0-7, 8-15, 16-23, and 24-31, which are applicable on the front-end ports.

Use this procedure to create an F_Port trunk group, and to add or remove member ports.

1. Select the **Port Admin** tab.
2. Select **View > Advanced**.
3. Select any port from the port group in which you want to create the trunk group.
4. Select **F-Port Trunking** from the **Actions** list.

The **F-Port Trunking** dialog box displays.

5. Select one or more ports in the **Ports for trunking** pane.
6. Click **Create Trunk Group**.

The **Select Trunk Index** dialog box displays asking you to select a trunk index.

7. Select the trunk index from the list populated with the index for all the ports.

A trunk group is created, identified by the trunk index, and containing the ports you selected.

8. Select the trunk group you just created.
9. Additional ports can be added by selecting a port from the **Ports for trunking** table and then clicking **Add Members**.

NOTE

To remove a port from the trunk group, select the port from the **Trunk Groups** table and then click **Remove Members**.

10 Click **OK** to save your changes.

Monitoring Performance

- Performance Monitor overview..... 125
- Opening the Performance Monitor window..... 130
- Creating basic performance monitor graphs..... 130
- Customizing basic monitoring graphs..... 131
- Advanced performance monitoring graphs..... 133
- Tunnel and TCP performance monitoring graphs..... 135
- Saving graphs to a canvas..... 136
- Adding graphs to an existing canvas..... 137
- Printing graphs..... 137
- Modifying graphs..... 137

Performance Monitor overview

The Web Tools Performance Monitoring tool graphically displays throughput (in megabytes per second) for each port and for the entire switch. To utilize performance monitoring, the EGM license must be enabled on the switch. Otherwise, when you select **Monitor > Performance Monitor**, access to this feature is denied and an error messages displays

Basic monitoring

The **Basic Monitoring** menu is standard in the Web Tools software. Any user logged into Web Tools with an associated role of zoneadmin or securityadmin cannot open **Performance Monitor**. The roles user, operator, basicswitchadmin, and properly configured user- defined roles are allowed to perform basic monitoring tasks, except save or display canvas operations in any Admin Domain context. Only users with the admin, switchadmin, and fabricadmin roles associated with their login accounts are able to save or display a canvas. Use the **Basic Monitoring** option in the **Performance Graphs** window to do the following:

- Create user-definable reports.
- Display a performance canvas for application-level or fabric-level views.
- Save persistent graphs across restarts (saves parameter data across restarts).

Advanced monitoring

The **Advanced Monitoring** menu is an optionally licensed feature. To utilize the Advanced Monitoring feature, you must have either the Advanced Performance Monitor license or the Fabric Vision license installed and you must log in using an account with an admin, switchadmin, or fabricadmin role, and properly configured user-defined roles.

The **Advanced Monitoring** option in the **Performance Graphs** window displays predefined reports and filter-based performance monitoring. You can use this feature to track the following:

- The number of words received and transmitted in Fibre Channel frames with a defined SID/DID pair.
- The number of times a particular filter pattern in a frame is transmitted by a port.

For detailed information on performance monitoring, refer to the *Fabric OS Administrator's Guide*.

Performance graphs

Each performance graph is displayed individually in a window, so it can be minimized, maximized, resized, and closed.

Graphs within the **Performance Monitor** window are updated every 30 seconds. When you first display the graph or if you modify the graph (such as to add additional ports), you might have to wait up to 30 seconds before the new values are shown.

When you have multiple graphs open in the **Performance Monitor** window, you can perform the following tasks:

- Select **Window** > **Tile** to view all graphs at once, tiled in the **Performance Monitor** window.
- Select **Window** > **Cascade** to view one graph at a time.
- Select **Window** > **Close All** to close all open Performance Monitor graphs in the **Performance Monitor** window.

In addition, the **Window** menu lists all open graphs. You can click **Window**, and then select a graph name to view that graph.

The **Tunnel and TCP Graph** option under the **Performance Graphs** window displays real-time performance monitoring charts for the Brocade 7800 Extension Switch, Brocade 7840 Extension Switch, and the FX8-24 extension blade. This option is not available on other platforms.

Admin Domain considerations

You must consider the following when configuring Admin Domain:

- If you are not the switch owner, only directly and indirectly-owned E_Ports, including EX_Ports are available.
- You can use the Advanced Performance Monitoring feature only in AD255 if there are user-defined Admin Domains or in AD0 if there are no other user-defined Admin Domains. Otherwise, access to Advanced Monitoring features in the **Performance Graphs** menu is unavailable.
- It is recommended that you define a user with a switchadmin role and give that user access to AD255 for the purpose of data collecting using the **Advanced Performance Monitor**.

Predefined performance graphs

Web Tools predefines basic graph types to simplify performance monitoring. A wide range of end-to-end fabric, LUN, device, and port metrics graphs are included.

The advanced monitoring graphs give more detailed performance information to help you manage your fabric. You can access the basic monitoring graphs on all switches; advanced monitoring graphs are available only on switches that have either the Advanced Performance Monitor license or the Fabric Vision license activated. The following table lists the basic monitoring graphs available.

TABLE 14 Basic performance graphs

Graph type	Display description
Port Throughput	The performance of a port, in bytes per second, for frames received and transmitted.

TABLE 14 Basic performance graphs (Continued)

Graph type	Display description
Switch Aggregate Throughput	The aggregate performance of all ports on a switch.
Blade Aggregate Throughput	The aggregate performance of all ports on a port card. This graph is available only for the Brocade DCX and DCX-4S enterprise-class platforms.
Switch Throughput Utilization	The port throughput, in Gbps at the time the sample is taken. For the Brocade DCX and DCX-4S enterprise-class platforms, this graph displays the throughput for each slot. You can customize this graph to display information for particular ports.
Port Error	CRC errors for a given port.
Switch Percent Utilization	The percentage utilization for each port in a switch. For the Brocade DCX, this graph displays the percent utilization for each slot. You can customize this graph to display information for particular ports.
Port Snapshot Error	The CRC error count between sampling periods for all the ports on a switch. For the Brocade DCX and DCX-4S enterprise-class platforms, this graph displays the CRC error rate for each slot. You can customize this graph to display information for particular ports.

The following table lists the advanced monitoring graphs available.

TABLE 15 Advanced performance monitoring graphs

Graph type	Display description
SID/DID Performance	The traffic between the SID-DID pair on the switch being managed. The member selection list in the LHS displays the port in the current switch only. The All Devices tab lists all the devices in the fabric. SID/DID Performance can be used to select the source and destination. For more information, refer to Creating SID/DID Performance graphs on page 133.
SCSI vs. IP Traffic	The percentage of SCSI versus IP frame traffic on each individual port. For more information, refer to Creating the SCSI vs. IP Traffic graph on page 134.
SCSI Commands by port and LUN (R, W, R/W)	The total number of read/write commands on a given port to a specific LUN. For more information, refer to Creating SCSI command graphs on page 134.

The following table lists each graph and indicates the supported port types for each graph. The port selection columns for each graph displays the supported ports.

TABLE 16 Supported port types for Brocade switches

Graph type	Physical FC ports	Logical FC ports	GbE ports
Port Throughput	P	P	P
Switch Aggregate Throughput	N/A	N/A	N/A
Blade Aggregate Throughput ¹	N/A	N/A	N/A

¹ The Blade Aggregate Throughput graph is supported only on the Brocade DCX and DCX-4S enterprise-class platforms.

TABLE 16 Supported port types for Brocade switches (Continued)

Graph type	Physical FC ports	Logical FC ports	GbE ports
Switch Throughput Utilization	P	N/A	P
Port Error	P	P	P
Switch Percent Utilization	P	N/A	P
Port Snapshot Error	P	P	N/A
SID/DID Performance	P	P	N/A
SCSI Commands	P	N/A	N/A
SCSI vs. IP Traffic	P	N/A	N/A

The labeling of the axes in the graphs depends on the switch type:

- For the Brocade DCX 8510-8, DCX 8510-4, and the DCX and DCX-4S enterprise-class platforms, slot numbers are displayed with expansion arrows next to them, as shown in the following figure. Click the arrows to expand and contract the list of ports per slot.
- Switches such as the Brocade 300, 5100, 5300, 6510, 6520, VA-40FC, 7800 Extension Switch, 7840 Extension Switch and the Brocade Encryption Switch do not have slot numbers because they have no blade FRUs, and therefore there is no need for slot numbering.
- For the Brocade DCX 8510-8, DCX 8510-4, and the DCX and DCX-4S enterprise-class platforms, the X-axis scales up to 409.6 Gbps in multiples of 2.
- For the Brocade 300, 5100, 5300, VA-40FC, 7800 Extension Switch, and the Brocade Encryption Switch, the X-axis scales up to 8.0 Gbps in increments of 0.8 Gbps.
- For the Brocade 6505, 6510, and the 6520, the X-axis scales up to 16.0 Gbps in increments of 0.16 Gbps.
- For the Brocade 7840 Extension Switch, the X-axis scales up to 40.0 Gbps in increments of 0.4 Gbps.

Port throughput utilization is represented by a horizontal bar for each selected port. The horizontal bar gets longer or shorter depending on the percent utilization for that port at the last poll time. Thin short vertical intersecting bars give a historical perspective by representing the highest and lowest values reached for each selected port since the graph was opened. A third bar between them represents the average of all values polled.

NOTE

Virtual ports on logical switches cannot be graphed.

The following figure shows how to access the list of Advanced Performance Monitoring graphs using Web Tools with the EGM license. This example displays the graphs available in the **Performance Monitor** window with either the Advanced Performance Monitor license or the Fabric Vision license installed. Note that the slot number is identified.

FIGURE 21 Accessing performance graphs

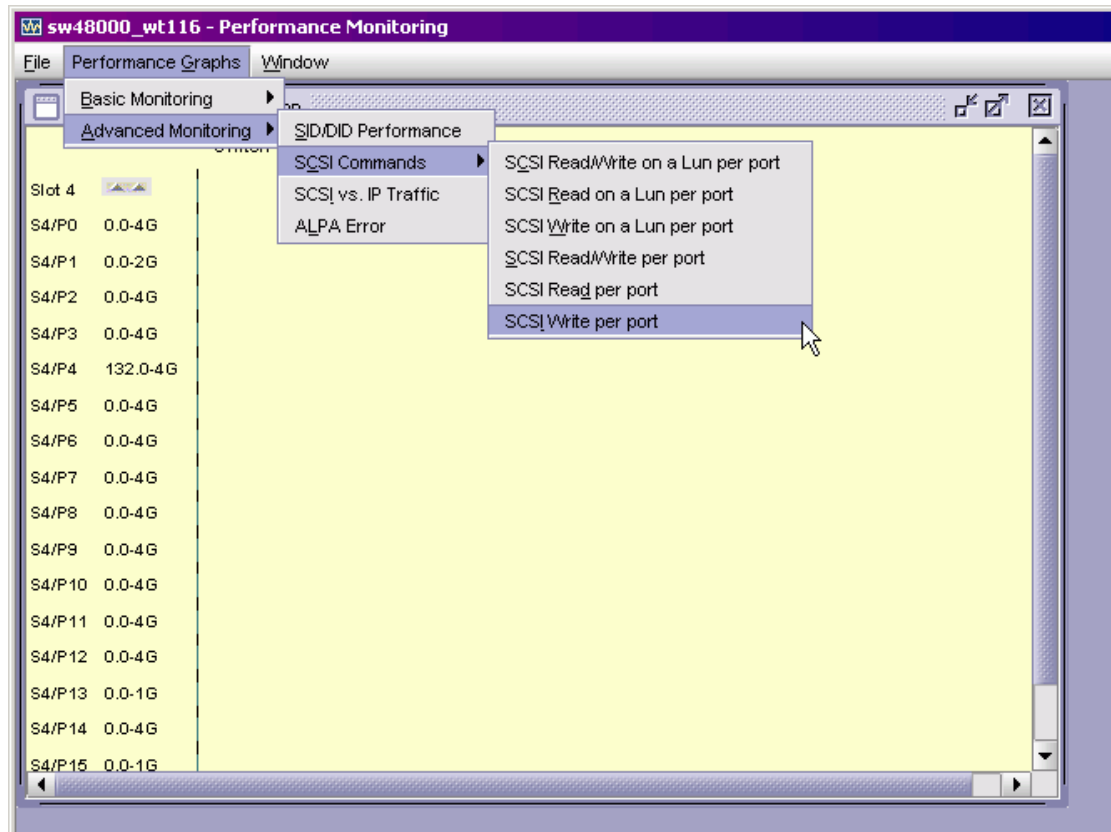

User-defined graphs

You can modify the predefined graphs to create your own customized graphs (refer to [Customizing basic monitoring graphs](#) on page 131 for more information). These user-defined graphs can be added and saved to canvas configurations.

Canvas configurations

A canvas is a saved configuration of graphs. The graphs can be either the Web Tools predefined graphs or user-defined graphs. Each canvas can hold up to eight graphs per window, with six shown in the following figure. Up to 20 canvases can be set up for different users or different scenarios. Each canvas is saved with a name and an optional brief description.

FIGURE 22 Canvas of six performance monitoring graphs

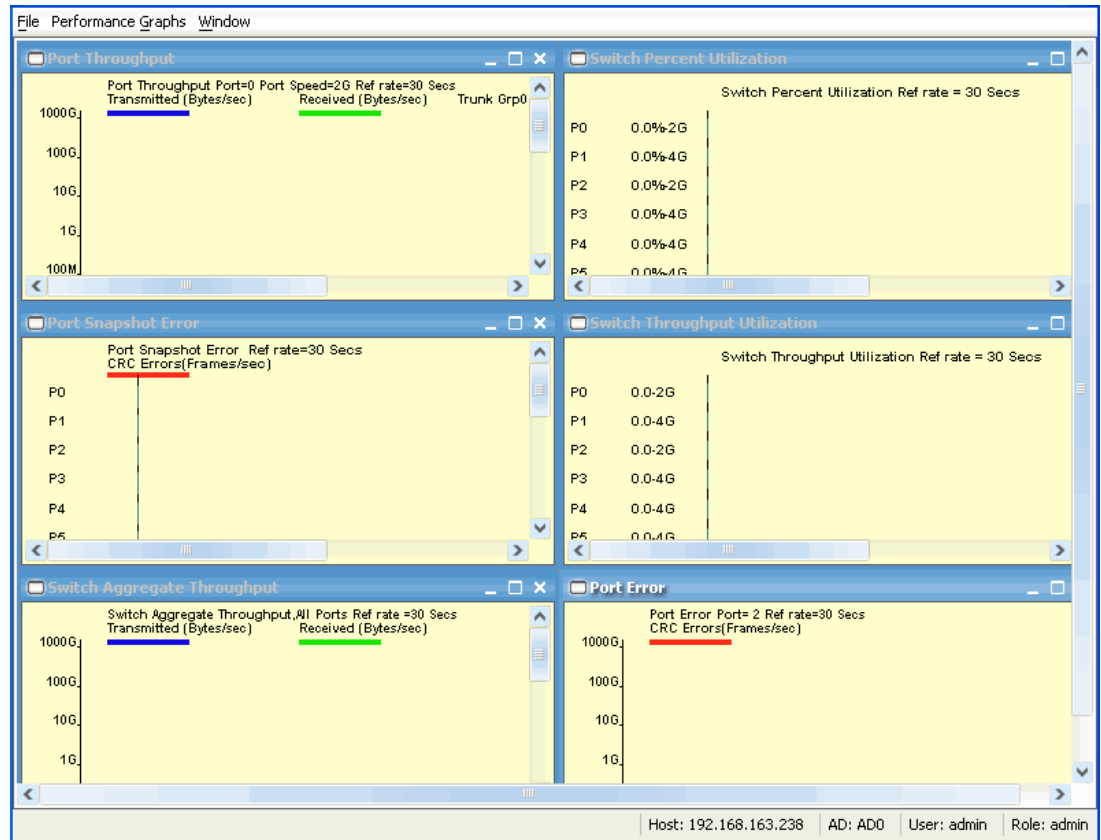

Opening the Performance Monitor window

To perform performance monitoring, you must use Web Tools with the EGM license; otherwise, access to performance monitoring is denied and an error messages displays.

To open the **Performance Monitor** window, perform the following steps.

1. Select a switch from the **Fabric Tree** and log in when prompted.
2. Click **Monitor > Performance Monitor**.

The **Performance Monitor** window displays.

Creating basic performance monitor graphs

To create the basic performance monitor graphs listed in [Predefined performance graphs](#) on page 126, perform the following steps.

1. Open the **Performance Monitor** window.
2. Select **Performance Graphs > Basic Monitoring > Graph Type** .

Depending on the type of graph you select, you might be prompted to select a slot or port for which to create a graph.

3. If prompted, drag the port into the **Enter/drag slot, port** field, or manually enter the slot and port information in the field, in the format *slot,port*.

NOTE

For the Brocade 300, 5100, 5300, 6505, 6510, 6520, VA-40FC, 7800 Extension Switch, 7840 Extension Switch, and the Encryption Switch, enter only a port number.

4. Click **OK**.

The graph is displayed in a window in the **Performance Monitor** window.

Customizing basic monitoring graphs

You can customize some of the basic performance monitoring graphs to display information for particular ports. For the Brocade 8510-8, Brocade 8510-4, and Brocade DCX and DCX-4S enterprise-class platforms, you can also customize these graphs to display information for a slot.

You can customize the following graphs:

- Switch Throughput Utilization
- Switch Percent Utilization
- Port Snapshot Error

The following procedure assumes that you already created one of these customizable graphs.

1. Create or access the graph you want to customize.

Refer to [Creating basic performance monitor graphs](#) on page 130 for instructions on creating a graph.

2. For Brocade DCX 8510-8, Brocade DCX 8510-4, and Brocade DCX and DCX-4S enterprise-class platforms, display the detailed port throughput utilization rates for each port in a slot by clicking the arrows next to a slot. The port information for that slot displays in the graph.

NOTE

For the Brocade 300, 5100, 5300, 6505, 6510, 6520, VA-40FC, 7800 Extension Switch, 7840 Extension Switch, and the Encryption Switch, proceed to step 3.

3. To display detailed port throughput utilization rates for particular ports only, right-click anywhere in the graph and click **Select Ports**.

The setup dialog box displays, as shown in the following figure.

The title of the dialog box varies, depending on the type of graph you are customizing, but the layout of the dialog box is the same. The following figure displays an example of the setup dialog box for the **Edit Switch Throughput Utilization** graph.

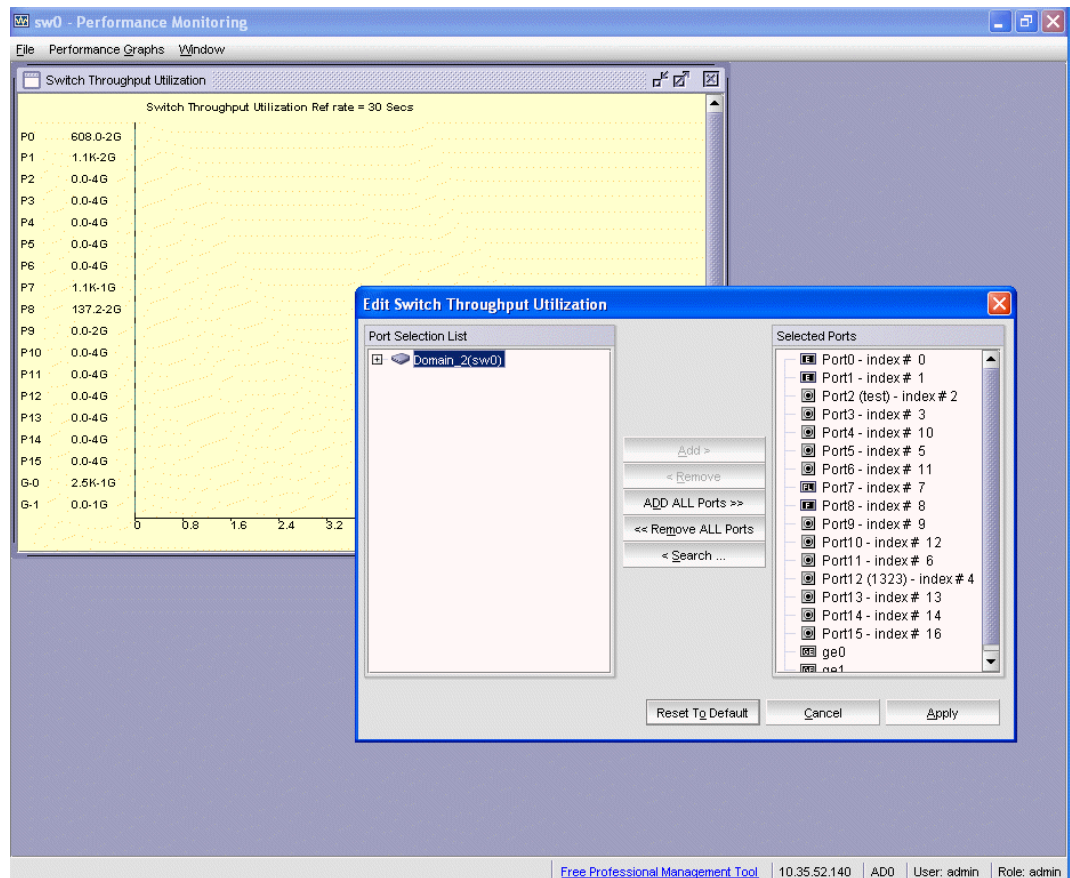
FIGURE 23 Select Ports for customizing the Switch Throughput Utilization graph

You can perform the following in the dialog box:

- a) Double-click the domain to expand the slot or port list.

NOTE

For the Brocade DCX 8510-8, Brocade DCX 8510-4, and Brocade DCX and Brocade DCX-4S enterprise-class platforms, click the plus signs (+) to expand the ports under each slot, as shown in the previous figure.

- b) Click the port you want to monitor in the graph in the **Port Selection List**.
Use **Shift+** click and **Ctrl+** click to select multiple ports.
- c) Click **Add** to move the selected ports to the **Selected Ports list**.
- d) Optional: Click **ADD ALL Ports** to add all of the ports in the **Port Selection List** to the Selected Ports list.
- e) Optional: Click **Search** to open the **Search Port Selection List** dialog box, from which you can search for all E_Ports, all F_Ports, or all port names with a defined string. Select the ports you want to add and click **Search** in the **Search Port Selection List** dialog box.
- f) Click **Apply**.

Only the selected ports are displayed in the graph.

Advanced performance monitoring graphs

This section describes how to create the advanced performance monitor graphs listed in [Predefined performance graphs](#) on page 126. Because the procedure for creating these graphs differs depending on the type of graph, each type is described separately in the sections that follow.

The advanced monitoring graphs are not supported for GbE ports.

NOTE

You must have an Advanced Performance Monitoring license installed to use the Advance Performance Monitor features. If user-defined Admin Domains are configured, Advanced Performance Monitoring works only in AD255.

Creating SID/DID Performance graphs

The SID/DID Performance graph displays the traffic between a SID/DID pair on the switch being managed.

To create a SID/DID Performance graph, perform the following steps.

1. Open the **Performance Monitoring** window.
2. Select **Performance Graphs > Advanced Monitoring > SID/DID Performance**. The **SID/DID Performance Setup** dialog box displays.
 - To see the end-to-end (EE) monitors that are currently set up on a particular port, proceed to step 3.
 - To specify the port, Source ID and Domain ID, skip to step 4.

NOTE

Only the FC ports of the launched switch display in the tree. The **All Devices** tab lists all the devices in the fabric and lets you select the source and destination. Slot and port information of other switches is not displayed in the tree.

3. Click a port from the **Slot/Port** or **Sid/Did Selection List**.
 - a) Drag the selected port into the **Enter/drag slot, port number** field.
 - b) Click **Retrieve preset EE monitors**. The current end-to-end monitors for that port are displayed in the "Current EE monitors set for selected port" table.
 - c) Optional: To display a performance graph for the current EE monitors set for the selected port, click a SID/DID pair in the table. You can select multiple Source ID and Destination IDs. Click **Select**. If you selected multiple SID/DID monitors, click **OK** in the confirmation dialog box that displays. Skip to step 6. If you do not want to display a performance graph for the current EE monitors set for the selected port, continue with step 4.
4. Select a source ID from the **Port or Sid/Did Selection List**, and click **Add Sid**.

You can also enter a source ID in the **Enter/drag SID number** field.
5. Select a destination ID from the **Port or Sid/Did Selection List**, and click **Add Did**.

You can also enter a destination ID in the **Enter/drag DID number** field.
6. Click **OK**.

If you selected multiple EE monitors, SIDs, or PIDs, a confirmation dialog box displays, reminding you that one graph is opened for each selection.

7. Click **Yes** to display the graphs.
8. When you close a graph, a dialog box asks if you want to save the monitor.
If you click **OK**, the monitor is saved, and persists if the switch is restarted.

Creating the SCSI vs. IP Traffic graph

The SCSI vs. IP Traffic graph displays the SCSI versus IP traffic for selected ports. For Brocade DCX 8510-8, Brocade DCX 8510-4, and Brocade DCX and Brocade DCX 4S enterprise-class platforms, the slot and port name are identified in the graph.

In a trunk group, the SCSI vs. IP Traffic graph displays only the master port and not the slave ports.

To create a SCSI vs. IP Traffic graph, perform the following steps.

1. Open the **Performance Monitor** window.
2. Select **Performance Graphs > Advanced Monitoring > SCSI vs. IP Traffic**.

The **SCSI vs. IP Traffic Setup** dialog box displays. This dialog box is similar to that shown in [Figure 23](#) on page 132.

3. Double-click the domain to expand the slot/port list.

NOTE

For the Brocade DCX 8510-8, Brocade DCX 8510-4, and Brocade DCX and Brocade DCX-4S enterprise-class platforms, click the plus sign (+) to expand the ports under each slot, as shown in [Figure 23](#) on page 132.

4. Click the port you want to monitor in the graph in the **Port Selection List**. Use **Shift** + click and **Ctrl** + click to select multiple ports.
5. Click **Add** to move the selected ports to the **Selected Ports** list.
6. Optional: Click **ADD ALL Ports** to add all of the ports in the **Port Selection List** to the **Selected Ports** list.
7. Optional : Click **Search** to open the **Search Port Selection List** dialog box, from which you can search for all E_Ports, all F_Ports, or all port names with a defined string. Select the ports you want to add and click **Search** in the **Search Port Selection List** dialog box.
8. Click **Apply** in the **SCSI vs. IP Traffic Setup** dialog box.

Only the selected ports are displayed in the SCSI vs. IP Traffic graph.

Creating SCSI command graphs

This graph displays the total number of read or write (or both) commands on a given port or to a specific LUN on a given port.

To create a SCSI command graph, perform the following steps.

1. Open the **Performance Monitor** window.
2. Select **Performance Graphs > Advanced Monitoring > SCSI Commands > Graph Type**.

The applicable setup dialog box displays.

3. Navigate to a **switch > slot > port** in the **Port Selection List**.
4. Click the port from the **Port Selection List** and drag it into the **Enter/drag port** field.
5. Optional: For the LUN per port graphs, enter a LUN number, in hexadecimal notation.

For the Brocade Encryption Switch, you can enter up to eight LUN masks For the Brocade 5100, 5300, 300, and 7800, you can enter up to eight LUN masks.

6. Click **OK**.

The selected graph displays in the canvas.

Tunnel and TCP performance monitoring graphs

This section describes how to generate the Tunnel and TCP performance monitor graphs. You can launch a maximum of four Tunnel and TCP graphs for a switch at a time. A total of 16 TCP connection graphs can be launched for a switch.

The TCP graphs available are:

- Sender RoundTrip
- Sender RoundTripVariance
- TCP DupAck
- TCP OOS
- TCP SlowStart
- TCP FastRetransmit
- TCP Tx(MB/sec)
- TCP Rx(MB/sec)

The Tunnel graphs available are:

- Throughput(MB/sec)
- Effective Throughput(MB/sec)
- CompressionRatio

For TCP connection graphs, tool tips are displayed only for all selected connections.

To create a Tunnel and TCP graph, perform the following steps.

1. Select **Monitor** > **Performance Monitor**.

The **Performance Monitor** window displays.

2. Select **Performance Graphs** > **Tunnel and TCP Graph**.

The **Tunnel and TCP Graph** dialog box displays.

3. Select the tunnel from the **Tunnels** list for which you want to generate the graphs.

For the Brocade 7800 Extension Switch, you can have a maximum of six circuit connections in a tunnel, and for the Brocade 7840 Extension Switch, you can have a maximum of four circuit connections in a tunnel, and for the FX8-24 extension blade, you can have a maximum of ten circuit connections in a tunnel.

4. In the **Tunnel and TCP** area at the bottom of the window, select the required check boxes for the statistic you want to graph.

Note that each column represents a different graph.

5. Click **Options** to set the display options for the graphs.

- **Range:** The range is from 3 through 30 seconds. The X axis is limited to 30 minutes. The graph scale starts with 0 minutes and auto-scales to draw the statistics. Once the 30 minutes graph is drawn, the first minute data is removed to accommodate the 31st minute values.
 - **Global auto scaling:** By default, this option is in disabled mode. You can either enable or disable this option. If enabled, the graph's X-axis scales up to 30 minutes and if it is disabled, the X-axis will scale up to 10 minutes
 - Number of graphs per row: Designate how many graphs you wish to appear in each row.
6. Click **Generate**.
 7. Click **Reset** to reset all the graphs.

NOTE

Brocade Network Advisor has an option for launching the **Tunnel and TCP Graph** dialog box from **FCIP Tunnels** dialog.

Tunnel and TCP graph chart properties

When a Tunnel and TCP graph displays, you can right-click the graph to access the display properties.

These properties include:

- Font selection
- Background color selection
- Title text
- Display zoom

These value selections are not persistent. When you close the graph, these values reset to the default settings.

In addition, you can print the graph and save the graph to a file.

Saving graphs to a canvas

Saving graphs is useful when you create customized graphs and do not want to recreate them each time you access the **Performance Monitor** window. When you save graphs, you must save them to a canvas.

The following procedure describes how to save graphs to a new canvas.

1. Open the **Performance Monitor** window.
2. Create basic or advanced Performance Monitor graphs, as described in [Creating basic performance monitor graphs](#) on page 130 and [Advanced performance monitoring graphs](#) on page 133.

The graphs display in the **Performance Monitor** window.

3. Select **File > Save Current Canvas Configuration**.

The **Save Canvas Configuration** dialog box displays.

4. Enter a name and description for the configuration and click **Save Canvas**. A message displays, confirming that the configuration was successfully saved to the switch.

Adding graphs to an existing canvas

The following procedure assumes that a canvas is already created.

To create a new canvas, you must first create graphs, as described in [Creating basic performance monitor graphs](#) on page 130 and [Advanced performance monitoring graphs](#) on page 133, and then save those graphs to a canvas, as described in [Saving graphs to a canvas](#) on page 136.

To add a graph to an existing canvas, perform the following steps.

1. Select **File** > **Display Canvas Configurations**.

The **Canvas Configuration List** displays. The error message "No Canvas configuration to display" displays if there are no saved canvas configurations.

2. Click a canvas in the list.
3. Click **Edit**.

The **Edit Canvas** dialog box displays.

4. Click **Add**.

A list of graphs displays.

5. Click a graph to add it to the canvas and click **Save**.

Printing graphs

You can print a single graph or all the graphs displayed on the selected canvas configuration. Only one canvas configuration can be opened at a time.

To print a graph, perform the following steps.

1. Open the **Performance Monitor** window.
2. Create a basic or advanced Performance Monitor graph as described in [Creating basic performance monitor graphs](#) on page 130 and [Advanced performance monitoring graphs](#) on page 133.
3. To print a single graph, right-click the graph and choose **Print**. To print all the graphs displayed on the selected canvas configuration, select **File** > **Print All Graphs**.
4. In the print dialog box, click **OK**.

Modifying graphs

To modify an existing graph that is saved in a canvas, perform the following steps.

1. Open the **Performance Monitor** window.
2. Select **File** > **Display Canvas Configurations**.

The **Canvas Configuration List** displays. A message "No Canvas configuration to display" displays if there are no saved canvas configurations.

3. Select a canvas from the list and click **Edit**.

The **Performance Monitor Canvas: Canvas Name** dialog box displays.

4. Select a graph from the list and click **Edit**.

NOTE

The **Edit** button is enabled only for the graphs that are configurable or editable.

5. Make changes in the **Edit** dialog box, as necessary.
6. Click **OK** to close the **Edit** dialog box.
7. Click **Save** to save the changes and close the **Performance Monitor Canvas** dialog box.
8. Click **Close** to close the **Canvas Configuration List**.

Administering Zoning

- [Zoning overview](#)..... 139
- [Zoning configurations](#) 140
- [Zoning management](#)..... 141
- [Zone configuration and zoning database management](#)..... 151
- [Best practices for zoning](#)..... 158

Zoning overview

This chapter describes zoning and provides the procedures for managing zoning. The **Zone Admin** window provides two zoning options on the left pane:

- Basic zones
- Traffic Isolation zones

You can perform basic zoning and Traffic Isolation zones using Web Tools and Web Tools with the EGM license.

Basic zones

Basic zoning enables you to partition a storage area network (SAN) into logical groups of devices that can access each other. For example, you can partition a SAN into two zones, winzone and unixzone, so that the Windows servers and storage do not interact with UNIX servers and storage.

Zones can be configured dynamically. They can vary in size, depending on the number of fabric-connected devices, and devices can belong to more than one zone. Because zone members can access only other members of the same zone, a device not included in a zone is not available to members of that zone.

Traffic Isolation zones

A Traffic Isolation zone (TI zone) is a special zone that creates a dedicated path for a specific traffic flow. TI zones are primarily for shaping and controlling traffic rather than partitioning access to storage.

LSAN zone requirements

An LSAN zone enables device connectivity between fabrics connected in Fibre Channel Routing (FCR) configurations without forcing you to merge fabrics. Extension switches provide multiple mechanisms to manage interfabric device connectivity. Zones that contain hosts and targets that are shared between the two fabrics need to be explicitly coordinated. To share devices between any two fabrics, you must create an LSAN zone in both fabrics considering the following:

- The name of an LSAN begins with the prefix LSAN_. The prefix is not case-sensitive.
- Members must be identified by their port WWN because port IDs are not necessarily unique across fabrics.

QoS zone requirements

A QoS zone is a special zone that assigns a Quality of Service (QoS) level for traffic flow between a given host or target pair. The members of a QoS zone are WWNs of the host or target pairs. QoS zones can contain only WWN members. A QoS zone has a special prefix, to differentiate it from a regular zone. The formats and meaning of the QoS zone name prefix are shown in the following table (the names are not case-dependent).

TABLE 17 QoS zone name prefixes

QoS name prefix	Priority	Bandwidth assignment
QoSH_	High	Five virtual circuits, 60% of available bandwidth
QoSM_	Medium	Four virtual circuits, 40% of available bandwidth
QoSL_	Low	Two virtual circuits, 10% of available bandwidth

Zoning configurations

The **Zone Administration** window is where all of the zoning tasks are performed.

When performing zoning tasks for switches in a mixed fabric—that is, a fabric containing two or more switches running different fabric operating systems—you should use the switch with the latest Fabric OS level. Refer to [Best practices for zoning](#) on page 158 for more recommendations about zoning.

Opening the Zone Admin window

Launching the **Zone Administration** window and performing any kind of zone configuration takes more time if there are a large number of entries in the zone database. If the zone count is above 10000, the time taken for completing the operation increases proportionately.

You cannot open the **Zone Administration** window from AD255 (physical fabric).

To open a **Zone Administration** window, perform the following steps.

1. Select a switch from the **Fabric Tree**.
2. Click **Configure > Zone Admin**.

The **Zone Administration** window displays, as shown in [Figure 24](#) on page 142.

Setting the default zoning mode

The default zoning mode has two options:

- **All Access** --All devices within the fabric can communicate with all other devices.
- **No Access** --Devices in the fabric cannot access any other device in the fabric.

NOTE

You should not change the default zone mode from No Access to All Access if there is no effective zone configuration and more than 120 devices are connected to the fabric.

NOTE

To use Admin Domains, you must set the default zoning mode to No Access prior to setting up the Admin Domains. To use the Admin Domain feature, the EGM license must be enabled on the switch; otherwise, access to this feature is denied. You cannot change the default zoning mode to All Access if user-specified Admin Domains are present in the fabric.

To set the default zoning mode, perform the following steps.

1. Open the **Zone Administration** window (refer to [Opening the Zone Admin window](#) on page 140).
2. Select **Zoning Actions** > **Set Default Mode**, and then select the access mode.

Zoning management

You can monitor and manage basic and Traffic Isolation zoning through the Web Tools **Zone Administration** window. The information in the **Zone Administration** window is collected from the selected switch.

If the FCS policy is activated in the fabric, zoning can be administered only from the primary FCS switch. If the selected switch has an Advanced Zoning license installed, but is not the primary FCS switch, the **Zone Admin** option is displayed, but not activated.

You must be logged in to the switch using a user name with one of the following roles associated with it to make changes to the zoning: zoneAdmin, admin, fabricAdmin, or any user-defined role with modify rights. All other roles allow only a view or read-only access. Most of the zoning operations are disabled in read-only mode.

A snapshot is taken of all the zoning configurations at the time you launch the **Zone Administration** window; this information *is not updated automatically* by Web Tools. To update this information, refer to [Refreshing Zone Administration window information](#) on page 144.

When you log in to a virtual switch, or select a virtual switch using the drop-down list under the **Fabric Tree** section in the **Switch Explorer** window, only the ports that are associated with the Virtual Fabric ID you selected are displayed in the member selection list, as shown in the following figure. You can use the **Add Other** button to add ports of other switches in the fabric.

FIGURE 24 Zone Administration window

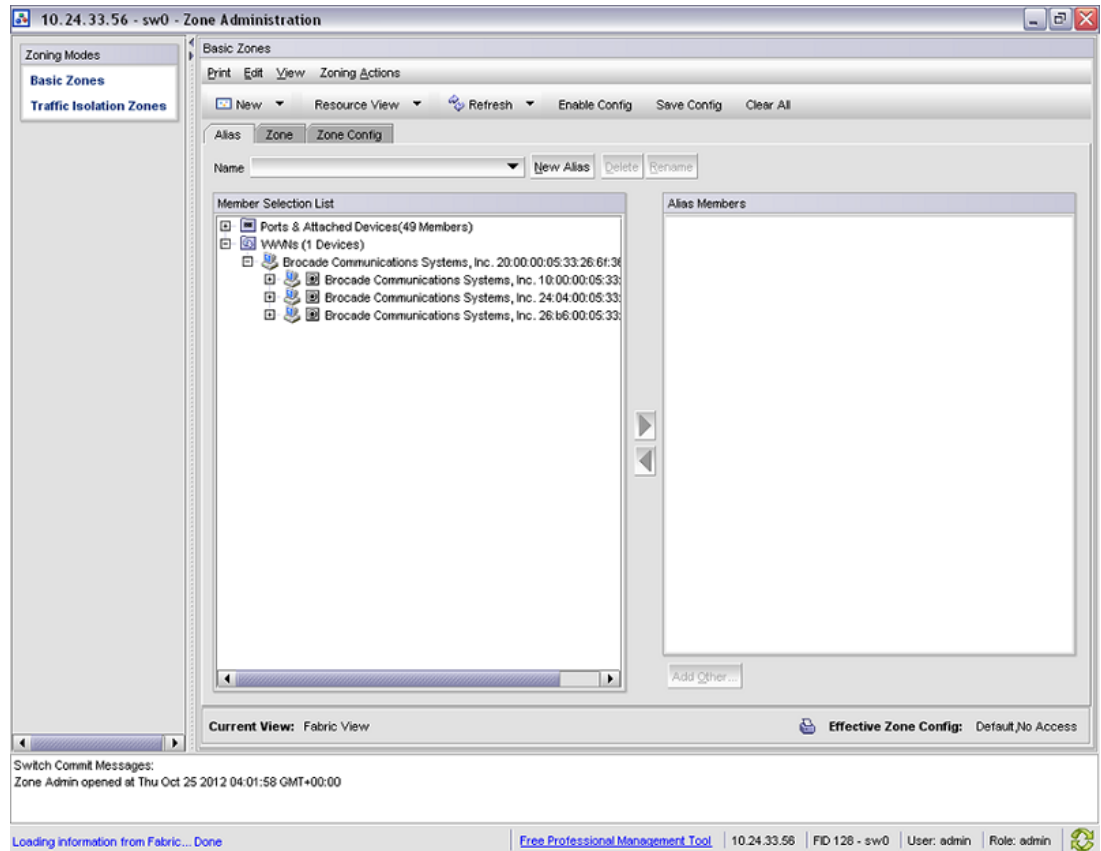

ATTENTION

Any changes you make in the **Zone Administration** window are held in a buffered environment and are not updated in the zoning database until you save the changes. If you close the **Zone Administration** window without saving your changes, your changes are lost. To save the buffered changes you make in the **Zone Administration** window to the zoning database on the switch, refer to [Saving local zoning changes](#) on page 145.

Note the following:

- "Saving" means updating the zoning database on the switch with the local changes from the Web Tools buffer.
- "Refreshing" means copying the current state of the zoning database on the switch to the Web Tools buffer, overwriting its current contents.

In the **Zone Administration** window, all WWNs also display vendor names.

The **Member Selection List** only lists the ports of the current switch and the devices of all the switches in the fabric. Slot and port information of other switches is not displayed in the tree.

Click the **Alias** tab to display which aliases the port or device is a member of. Also, you can right-click the device nodes and click **View Device Detail** to display detailed information about the selected device.

The **Member Selection List** panel displays only physical FC ports. To verify whether you have any unzoned devices, you must use Brocade Network Advisor to analyze zone configurations.

In the **Member Selection List**, you can differentiate between node WWN and port WWN by their icons, as shown in [Figure 25](#) and [Figure 26](#).

FIGURE 25 Port WWN icon for host

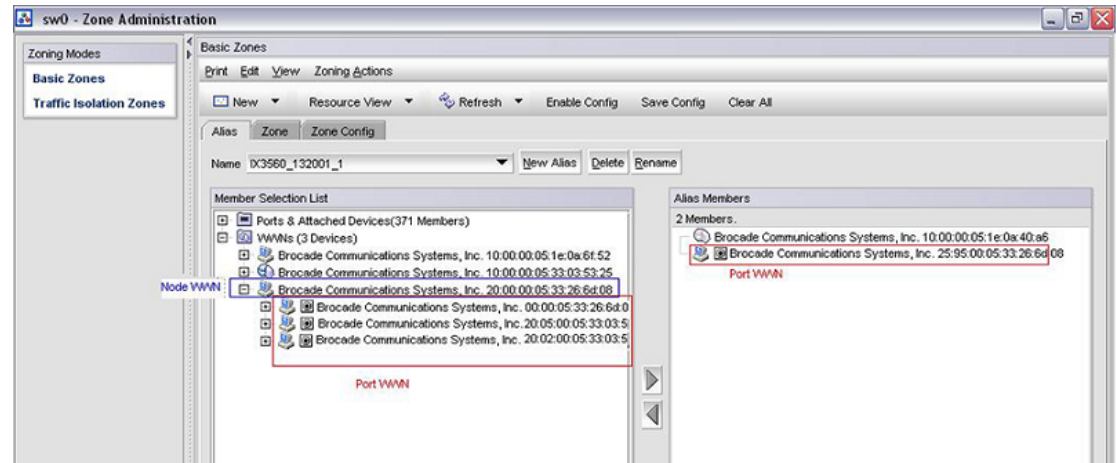
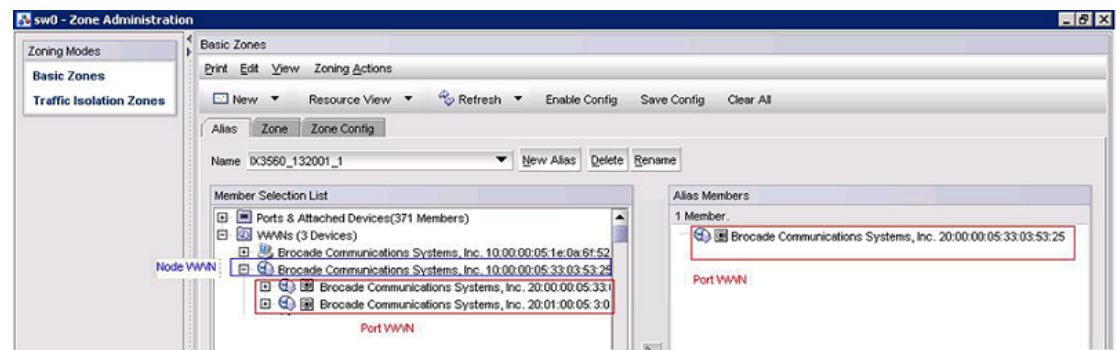

FIGURE 26 Port WWN icon for device



Admin Domain considerations: The **Member Selection List** panel displays a filtered list of ports that are:

- Direct port members that are zoneable and are displayed in the tree.
- Indirect port members to which owned devices are attached are displayed in the tree, but cannot be added to a zone or alias.
- Direct device members that are zoneable and are displayed in the tree.
- Indirect device members (devices that are currently attached to owned ports) that are also zoneable and displayed in the tree. But if such a device is later moved to a non-owned port, it will no longer be displayed or zoneable.
- Switches and blades that are displayed only if they contain owned ports or devices, regardless of switch ownership, such as the FS8-18 Encryption blade.
- Ports that are indirect members only because the switch is owned *are not displayed*.

NOTE

When no user-defined Admin Domains are present on the switch, AD0 displays the port count. If there are user-defined Admin Domains, AD0 does not show the port count and the user-defined AD displays the port count.

Refreshing fabric information

This function refreshes the display of *fabric elements* only (switches, ports, and devices). It does not affect any zoning element changes or update zone information in the **Zone Administration** window. You can refresh the fabric element information displayed at any time.

To refresh fabric information.

1. Open the **Zone Administration** window.
2. Select **View > Refresh From Live Fabric**.

This refreshes the status for the fabric, including switches, ports, and devices.

NOTE

Depending on the role associated with your user name or if the switch is owned by the current Admin Domain you are logged in to, you may not be able to modify zones or ports in other Admin Domains.

Refreshing Zone Administration window information

The information displayed in the **Zone Administration** window is initially a snapshot of the contents of the fabric zoning database at the time the window is launched. Any changes you make to this window are saved to a local buffer; but they are not applied to the fabric zoning database until you invoke one of the transactional operations listed in the **Zoning Actions** menu.

Any local zoning changes are buffered by the **Zone Administration** window until explicitly saved to the fabric. If the fabric zoning database is independently changed by another user or from another interface (for example, the CLI) while Web Tools zoning changes are still pending, the refresh icon starts to blink (after a 15-30 second polling delay). You can then decide to refresh the current Web Tools zoning view to reflect the new, externally changed contents of the fabric zoning database, in which case any pending local changes are lost, or you can ignore the blinking refresh icon and save your local changes, overwriting the external changes that triggered the icon to blink.

You can refresh zoning to back out of current, unsaved work and start over.

You can refresh the zoning information at any time, either using the refresh icon (whether it is flashing or not) or from the **View** menu.

The following procedure updates the information in the **Zone Administration** window with the information saved in the zoning database on the switch.

ATTENTION

When you refresh the buffered information in the **Zone Administration** window, any zoning configuration changes you made and not yet saved are erased from the buffer and replaced with the currently enabled zone configuration information that is saved on the switch.

To refresh the **Zone Administration** window, perform the following steps.

1. Launch the **Zone Administration** window as described in [Opening the Zone Admin window](#) on page 140.
2. Select **View > Refresh Zoning** or click **Refresh**.

This redisplay the information in the **Zone Administration** window with the information in the switch's zoning database. This action also refreshes the fabric information as described in [Refreshing fabric information](#) on page 144. Any unsaved zoning changes are deleted.

Saving local zoning changes

All information displayed and all changes made in the **Zone Administration** window are buffered until you save the changes. In that case, any other user looking at the zone information for the switch does not see the changes you have made until you save them.

Saving the changes propagates any changes made in the **Zone Administration** window (buffered changes) to the zoning database on the switch. If another user has a zoning operation in progress at the time that you attempt to save changes, a warning displays that indicates that another zoning transaction is in progress on the fabric. You can select to abort the other transaction and override it with yours.

If the zoning database size exceeds the maximum allowed, you cannot save the changes. The zoning database summary displays the maximum zoning database size.

This action updates the entire contents of the **Zone Administration** window, not just the selected zone, alias, or configuration. You can save your changes at any time during the **Zone Administration** session.

To save the local zone changes, perform the following steps.

1. Make the zoning changes in the **Zone Administration** window.
2. Select **Zoning Actions > Save Config**.

If you have made changes to a configuration, you must enable the configuration before the changes are effective. To enable the configuration, refer to [Enabling zone configurations](#) on page 153.

Selecting a zoning view

You can define how zoning elements are displayed in the **Zone Administration** window. The zoning view you select determines how members are displayed in the **Member Selection List** panel ([Figure 24](#) on page 142). The views filter the fabric and device information displayed in the **Member Selection List** for the selected view, making it easier for you to create and modify zones, especially when creating "hard zones."

Depending on the method you use to zone, certain tabs might or might not be available in the **Zone Administration** window.

There are two views of defining members for zoning:

- **Fabric View** --Displays the physical hierarchy of the fabric, a list of the attached and imported physical devices (by WWN), and a list of the FC Virtual Initiators on switches that support iSCSI. In the Fabric View, you can select ports for port-based zoning or devices for WWN-based zoning.
- **Devices Only** --Displays a list of the attached and imported physical devices by WWN. You cannot select ports for port-based or mixed zoning schemes, nor can you select virtual initiators for iSCSI FC Zone creation.

To define the view of the fabric resource, perform the following steps.

1. Launch the **Zone Administration** window as described in [Opening the Zone Admin window](#) on page 140.
2. Select **View > Choose Fabric Resources View**.
3. Define the way you want to view the fabric resource and click **OK**.

Creating and populating zone aliases

An alias is a logical group of port index numbers and WWNs. Specifying groups of ports or devices as an alias makes zone configuration easier, by enabling you to configure zones using an alias rather than providing a long string of individual members. You can specify members of an alias using the following methods:

- Identifying members by switch domain and port index number pair, for example, 2, 20.
- Identifying members by device node and device port WWNs.

For more information on enabling the configuration, refer to [Enabling zone configurations](#) on page 153.

To create a zone alias, perform the following steps.

1. Open the **Zone Administration** window as described in [Opening the Zone Admin window](#) on page 140.
2. Select a format to display zoning members in the **Member Selection List** as described in [Selecting a zoning view](#) on page 145.
3. Select the **Alias** tab and click **New Alias**.

The **Create New Alias** dialog box displays.

4. In the **Create New Alias** dialog box, enter a name for the new alias and click **OK**.

The new alias displays in the **Name** list.

5. Expand the **Member Selection List** to view the nested elements.

The choices available in the **Member Selection List** depend on the selection in the **View** menu.

6. Click elements in the **Member Selection List** that you want to include in the alias. The right arrow becomes active.
7. Click the right arrow to add alias members.

Selected members move to the **Alias Members** window.

8. Optional: Repeat steps 6 and 7 to add more elements to the alias.
9. Optional: Click **Add Other** to include a WWN or port that is not currently a part of the fabric.
10. Select **Actions** > **Save Config** to save the configuration changes.

Adding and removing members of a zone alias

For more information on enabling the configuration, refer to [Enabling zone configurations](#) on page 153.

NOTE

When you assign a node WWN to an alias or zone, all of the WWPNs associated to that node are also moved. This functionality is supported only for IM0 mode. This behavior is duplicated in Brocade Network Assistant zoning. This functionality is supported only by selecting the node WWN and assigning it to the alias or zone.

To add or remove zone alias members, perform the following steps.

1. Open the **Zone Administration** window as described in [Opening the Zone Admin window](#) on page 140.
2. Select the **Alias** tab.
3. Select the alias you want to modify from the **Name** list.

4. Select an element in the **Member Selection List** that you want to add to the alias, or select an element in the **Alias Members** list that you want to remove.
5. Click the right arrow to add the selected alias member, or click the left arrow to remove the selected alias member.

The alias is modified in the Zone Admin buffer.

6. Select **Zoning Actions** > **Save Config** to save your configuration changes.

Renaming zone aliases

The new alias name cannot exceed 64 characters and can contain alphabetic, numeric, and underscore characters.

For more information on enabling the configuration, refer to [Enabling zone configurations](#) on page 153.

To change the name of a zone alias, perform the following steps.

1. Open the **Zone Administration** window as described in [Opening the Zone Admin window](#) on page 140.
2. Select the **Alias** tab and select the alias you want to rename from the **Name** list.
3. Click **Rename**.

The **Rename an Alias** dialog box displays.

4. Enter a new alias name and click **OK**.

The alias is renamed in the Zone Admin buffer. At this point, you can either save your changes or save and enable your changes.

5. Select **Zoning Actions** > **Save Config** to save the configuration changes.

Deleting zone aliases

You can remove a zone alias from the Zone Admin buffer. When a zone alias is deleted, it is no longer a member of the zones of which it was once a member.

NOTE

If you delete the only member zone alias, an error message is issued when you attempt to save the configuration.

To delete the zone aliases, perform the following steps.

1. Open the **Zone Administration** window as described in [Opening the Zone Admin window](#) on page 140.
2. Select the **Alias** tab.
3. Select the alias you want to delete from the **Name** list. and click **Delete**.

The **Confirm Deleting Alias** dialog box displays.

4. Click **Yes**.

The selected alias is deleted from the Zone Admin buffer. At this point, you can either save your changes or save and enable your changes.

5. Select **Zoning Action** > **Save Config** to save the configuration changes.

To enable the configuration, refer to [Enabling zone configurations](#) on page 153.

Creating and populating zones

A zone is a region within the fabric where specified switches and devices can communicate. A device can communicate only with other devices connected to the fabric within its specified zone.

To create a zone, perform the following steps.

1. Open the **Zone Administration** window as described in [Opening the Zone Admin window](#) on page 140.
2. Select a format to display zoning members in the **Member Selection List** as described in [Selecting a zoning view](#) on page 145.
3. Select the **Zone** tab.
4. Click **New Zone**.

The **Create New Zone** dialog box displays.

5. In the **Create New Zone** dialog box, enter a name for the new zone, and click **OK**.

LSAN zones and QoS zones have specific naming requirements:

- For LSAN zones, refer to [LSAN zone requirements](#) on page 139.
- For QoS zones, refer to [QoS zone requirements](#) on page 140.

The new zone displays in the **Name** list.

6. Expand the **Member Selection List** to view the nested elements. The choices available in the list depend on the selection made in the **View** menu.
7. Select an element in the **Member Selection List** that you want to include in your zone.

Note that LSAN zones should contain only port WWN members. The right arrow becomes active.

8. Click the right arrow to add the zone member.

The selected member is moved to the **Zone Members** window.

9. Optional: Repeat steps 7 and 8 to add more elements to your zone.
10. Optional: Click **Add Other** to include a WWN or port that is not currently a part of the fabric. At this point, you can either save your changes or save and enable your changes.
11. Select **Zoning Actions** > **Save Config** to save the configuration changes.

To enable the configuration, refer to [Enabling zone configurations](#) on page 153.

Adding and removing members of a zone

For information on enabling the configuration, refer to [Enabling zone configurations](#) on page 153.

NOTE

When you assign a node WWN to an alias or zone, all of the WWPNS associated to that node are also moved. This functionality is supported only for IM0 mode. This behavior is duplicated in Brocade Network Assistant zoning. This functionality is supported only by selecting the node WWN and assigning it to the alias or zone.

To add or remove zone members, perform the following steps.

1. Open the **Zone Administration** window as described in [Opening the Zone Admin window](#) on page 140.
2. Select the **Zone** tab.
3. Select the zone you want to modify from the **Name** list.

The zone members for the selected zone are listed in the **Zone Members** list.

4. Highlight an element in the **Member Selection List** that you want to include in your zone, or highlight an element in the **Zone Members** list that you want to delete.
5. Click the right arrow to add a zone member, or click the left arrow to remove a zone member. The zone is modified in the Zone Admin buffer.
6. Select **Zoning Actions** > **Save Config** to save the configuration changes.

Renaming zones

For information on enabling the configuration, refer to [Enabling zone configurations](#) on page 153.

To change the name of a zone, perform the following steps.

1. Open the **Zone Administration** window as described in [Opening the Zone Admin window](#) on page 140.
2. Click the **Zone** tab.
3. Select the zone you want to rename from the **Name** list.
4. Click **Rename**.
5. In the **Rename a Zone** dialog box, enter a new zone name and click **OK**. The zone is renamed in the Zone Admin buffer.
6. Select **Zoning Actions** > **Save Config** to save the configuration changes.

Cloning zones

To perform clone operations for zoning, the EGM license must be installed on the switch; otherwise, access to cloning zones is denied and an error message displays.

The EGM license is required only for 8 Gbps platforms, such as the following:

- Brocade Encryption Switch
- Brocade 300, 5300, and 5100 switches
- Brocade VA-40FC
- Brocade 7800

For non-8 Gbps platforms, all functionalities are available without the EGM license.

To clone a zone configuration, perform the following steps.

1. Open the **Zone Administration** window as described in [Opening the Zone Admin window](#) on page 140
2. Click the **Zone** tab.
3. Select the zone you want to clone from the **Name** list.
4. Click **Clone**.
5. In the **Clone an Existing Zone** dialog box, enter a name for the copied zone.
6. Click **OK**. The selected zone is copied from the Zone Admin buffer.
7. Select **Zoning Actions** > **Save Config** to save the configuration changes. Because no changes were made to the effective configuration, you do not need to enable the configuration.

Deleting zones

For information on enabling the configuration, refer to [Enabling zone configurations](#) on page 153.

To delete a zone, perform the following steps.

1. Open the **Zone Administration** window as described in [Opening the Zone Admin window](#) on page 140.
2. Click the **Zone** tab.
3. Select the zone you want to delete from the **Name** menu and click **Delete**.
4. On the confirmation dialog box, click **Yes**.
The selected zone is deleted from the Zone Admin buffer. At this point, you can either save your changes or save and enable your changes.
5. Select **Zoning Actions** > **Save Config** to save the configuration changes.

Creating and populating enhanced Traffic Isolation zones

An enhanced Traffic Isolation zone (TI zone) is a special zone that creates a dedicated path for a specific traffic flow. When an enhanced TI zone is activated, inter-switch traffic from a zone member is directed to E_Ports that are included in the TI zone. Traffic from outside the TI zone is excluded. A maximum of 255 TI zones can be configured. LSAN devices can be added only in TI zones created in the backbone switch.

A port may be assigned to more than one enhanced TI zone in a fabric. A port can be part of more than one enhanced TI zone provided the following conditions are satisfied:

- All the switches in the fabric should have Fabric OS v 6.4 or later.
- A port can be assigned to multiple TI zones that have the same failover state.
- The fabric is composed entirely of 8 Gbps-capable FC platform or GoldenEye-2 switches.

To create and populate an enhanced TI zone, perform the following steps.

1. Open the **Zone Administration** window as described in [Opening the Zone Admin window](#) on page 140.
2. Under **Zoning Modes**, select **Traffic Isolation Zones**.
The **Traffic Isolation Zones** view displays.
3. Click **New** on the menu bar.
The **Add TI Zone** dialog box displays.
4. Expand the **Member Selection List** to view the nested elements.
5. Select an element in the **Member Selection List** that you want to include in your zone.
The right arrow becomes active.
6. Click the right arrow to add the zone member.
The selected member is moved to the **Zone Members** window.

NOTE

All switches in the fabric must be running Fabric OS v6.4.0 or later and all the ports in the TI zones must be in the same failover mode.

7. Optional: Repeat steps 5 and 6 to add more elements to your TI zone.
8. When you are finished, click **OK**. The **Traffic Isolations Zones** window displays.
9. Click **Apply** to save the TI zone configuration.

Zone configuration and zoning database management

A zone configuration is a group of zones; zoning is enabled on a fabric by enabling a specific configuration. You can specify members of a configuration using zone names.

The following figure displays a sample zoning database and the relationship between the zone aliases, zones, and zoning configuration. The database contains one zoning configuration, *myconfig*, which contains two zones: *Zone A* and *Zone B*. The database also contains four aliases, which are members of *Zone A* and *Zone B*. *Zone A* and *Zone B* also have additional members other than the aliases.

FIGURE 27 Sample zoning database

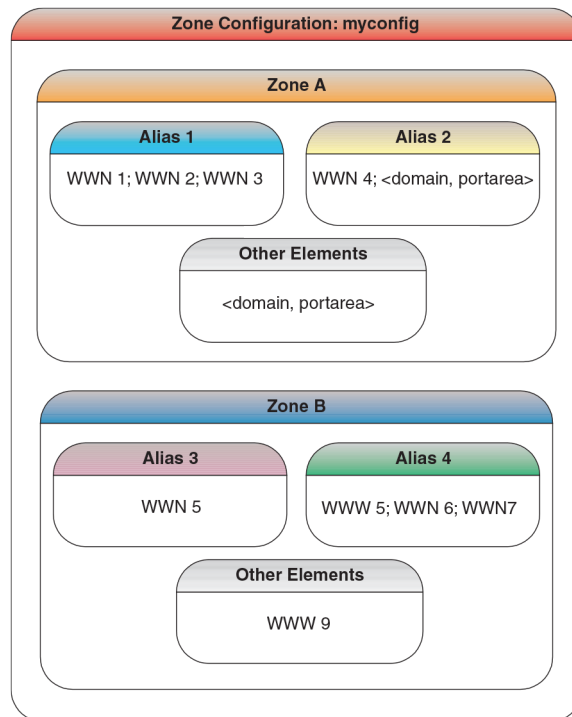

Creating zone configurations

To create a zone configuration, perform the following steps. After creating a zone configuration, you must explicitly enable it for it to take effect.

For information on enabling the configuration, refer to [Enabling zone configurations](#) on page 153.

NOTE

Any changes made to the currently enabled configuration do not display until you re-enable the configuration.

To create zone configurations, perform the following steps.

1. Open the **Zone Administration** window as described in [Opening the Zone Admin window](#) on page 140.
2. Select a format to display zoning members in the **Member Selection List** as described in [Selecting a zoning view](#) on page 145.
3. Select the **Zone Config** tab and click **New Zone Config**.
4. In the **Create New Config** dialog box, enter a name for the new configuration and click **OK**.
The new configuration displays in the **Name** list.
5. Expand the **Member Selection List** to view the nested elements.
The choices available in the list depend on the selection made in the **View** menu.
6. Select an element in the **Member Selection List** that you want to include in your configuration.
The right arrow becomes active.
7. Click the right arrow to add configuration members.
Selected members are moved to the **Config Members** window.
8. Repeat steps 6 and 7 to add more elements to your configuration.
9. Select **Zoning Actions** > **Save Config** to save the configuration changes.

Adding or removing zone configuration members

For information on enabling the configuration, refer to [Enabling zone configurations](#) on page 153.

To add or remove members of a zone configuration, perform the following steps.

NOTE

You can make changes to a configuration that is currently enabled; however, changes do not display until you re-enable the configuration.

1. Open the **Zone Administration** window as described in [Opening the Zone Admin window](#) on page 140.
2. Select the **Zone Config** tab.
3. Select the configuration you want to modify from the **Name** list.
4. Click an element in the **Member Selection list** that you want to include in your configuration or select the element in the **Config Members** list that you want to delete.
5. Click the right arrow to add a configuration member or the left arrow to remove a configuration member.
6. Select **Zoning Actions** > **Save Config** to save the configuration changes.

Renaming zone configurations

The new name cannot exceed 64 characters and can contain alphabetic, numeric, and underscore characters.

NOTE

You cannot rename the currently enabled configuration.

To rename the zone configuration, perform the following steps.

1. Open the **Zone Administration** window as described in [Opening the Zone Admin window](#) on page 140.
2. Select the **Zone Config** tab.
3. Select the configuration you want to rename from the **Name** list and click **Rename**.
4. In the **Rename a Config** dialog box, enter a new configuration name and click **OK**.
The configuration is renamed in the configuration database.
5. Select **Zoning Actions** > **Save Config** to save the configuration changes.

Cloning zone configurations

You must use Web Tools with the EGM license to perform cloning operations for zone configurations; otherwise, access to cloning operation for zone configuration is denied and an error message displays.

To clone a zone configuration, perform the following steps.

1. Open the **Zone Administration** window as described in [Opening the Zone Admin window](#) on page 140.
2. Select the **Zone Config** tab.
3. Select the zone configuration you want to clone from the **Name** list.
4. Click **Clone**.
5. In the **Copy An Existing Zone Config** dialog box, enter a name for the copied zone and click **OK**.
The selected zone is copied from the Zone Admin buffer.
6. Select **Zoning Actions** > **Save Config** to save the configuration changes.

No changes are made to the effective configuration. You do not need to enable the configuration.

Deleting zone configurations

To delete a zone configuration, perform the following steps.

NOTE

You cannot delete an enabled configuration.

1. Open the **Zone Administration** window as described in [Opening the Zone Admin window](#) on page 140.
2. Select the **Zone Config** tab.
3. Select the configuration you want to delete from the **Name** list and click **Delete**.
4. On the confirmation dialog box, click **Yes**. The selected configuration is deleted from the configuration database.
5. Select **Zoning Actions** > **Save Config** to save the configuration changes.

Enabling zone configurations

Several zone configurations can reside on a switch at the same time, and you can quickly alternate between them. For example, you might want to have one configuration enabled during the business hours and another enabled overnight. However, only one zone configuration can be enabled at a time.

When you enable a zone configuration from Web Tools, the entire zoning database is automatically saved, and then the selected zone configuration is enabled.

If the zoning database size exceeds the maximum allowed, you cannot enable the zone configuration. The zoning database summary displays the maximum zoning database size.

To enable the zone configuration, perform the following steps.

1. Open the **Zone Administration** window as described in [Opening the Zone Admin window](#) on page 140.
2. Select **Zoning Actions > Enable Config**.
3. On **Enable Config**, select the configuration to be enabled from the menu.
4. Click **OK** to save and enable the selected configuration.

Disabling zone configurations

When you disable the active configuration, the Advanced Zoning feature is disabled on the fabric, and all devices within the fabric can communicate with all other devices. This does not mean that the zoning database is deleted, however, only that there is no configuration active on the fabric.

When you disable a zone configuration from Web Tools, keep in mind that the entire zoning database is automatically saved, and then the selected zone configuration is disabled.

NOTE

When you disable the active configuration, Advanced Zoning is disabled on the fabric, and according to the default zone set, devices within the fabric can or cannot communicate with other devices.

To disable a zone configuration, perform the following steps.

1. Open the **Zone Administration** window as described in [Opening the Zone Admin window](#) on page 140.
2. Select **Zoning Actions > Disable Zoning**.
The **Disable Config** warning message displays.
3. Click **Yes** to save and disable the current configuration.

Displaying enabled zone configurations

The enabled zone configuration window displays the actual content of the single zone configuration that is currently enabled on the fabric, whether it matches the configuration that was enabled when the current **Zone Admin** session was launched or last refreshed. The zones are displayed, and their contents (ports, WWNs) are displayed next to them. Aliases are not displayed in the enabled zone configuration. If there is no active zone configuration enabled on the switch, a message displays to that effect.

NOTE

The enabled configuration is listed in the lower-right corner of the **Zone Administration** window.

Viewing the enabled zone configuration name without opening the Zone Administration window

To view the enabled zone configuration name, perform the following steps.

Select a logical switch from the **Logical Switch** list in the top-right corner of the **Switch Explorer** window.

The selected switch displays in the **Switch View**.

You can view the current zone configuration name (if one is enabled) in the lower portion of the Switch Events and Switch Information window. If no zone configuration is enabled, the field displays "No configuration in effect".

Viewing detailed information about the enabled zone configuration

To view detailed information about the enabled zone configuration, perform the following steps.

1. Open the **Zone Administration** window, as described on [Opening the Zone Admin window](#) on page 140.

The zone configuration in effect at the time you launched the **Zone Administration** window is identified in the lower-right corner. It is also updated if you manually refresh the **Zone Administration** window contents by clicking the refresh icon at the lower-right corner of the **Zone Administration** window, or when you enable a configuration through the **Zone Administration** window.



CAUTION

Clicking the refresh icon overwrites all local unsaved zoning changes. If anyone has made any changes to the zones outside of your Zone Admin session, those changes are applied.

2. To identify the most recently effective zone configuration without saving or applying any changes you made in the **Zone Administration** window, select **Print > Print Effective Zone Configuration** in the **Zone Administration** window.

NOTE

If no zone is enabled, a message displays, indicating that there is no active zoning configuration on the switch.

3. Optional: Click **Print** located in the **Print Effective Zone Configuration** dialog box to print the enabled zone configuration details.

NOTE

You must use Brocade Network Advisor to print the zone database summary configurations, display zone configuration summaries, and create configuration analysis reports.

Adding a WWN to multiple aliases and zones

This procedure enables you to configure a WWN as a member in a zone configuration prior to adding that device to the fabric. Specifically, it is useful if you want to add a WWN to all or most zoning entities. The added WWN does not need to currently exist in the fabric.

To add a WWN, perform the following steps.

1. Open the **Zone Administration** window as described in [Opening the Zone Admin window](#) on page 140.

2. Select **Edit > Add WWN**.

The **Add WWN** dialog box displays.

3. Enter a WWN value in the **WWN** field and click **OK**.

The **Add WWN** dialog box displays all the zoning elements that include the new WWNs. All of the elements are selected by default.

4. Click items in the list to select or clear, and click **Add** to add the new WWN to all the selected zoning elements.

The WWN is added to the Zone Admin buffer and can be used as a member.

Different icons are used to differentiate between node WWN and port WWN.

Removing a WWN from multiple aliases and zones

Use this procedure if you want to remove a WWN from all or most zoning entities.

1. Open the **Zone Administration** window as described in [Opening the Zone Admin window](#) on page 140.

2. Select **Edit > Delete WWN**.

The **Delete WWN** dialog box displays.

3. Enter a WWN value in the **WWN** field and click **OK**.

The **Delete WWN** dialog box displays all the zoning elements that include the WWN.

4. Click items in the list to select or unselect, and click **Delete** to delete the WWN from all the selected zoning elements.

The WWN is deleted from the selected items in the Zone Admin buffer.

Replacing a WWN in multiple aliases and zones

This procedure enables you to replace a WWN throughout the Zone Admin buffer. This is helpful when exchanging devices in your fabric and helps you to maintain your current configuration.

To replace a WWN in multiple aliases and zones, perform the following steps.

1. Launch the **Zone Administration** window as described in [Opening the Zone Admin window](#) on page 140.

2. Select **Edit > Replace WWN**.

The **Replace WWN** dialog box displays.

3. Enter the WWN to be replaced in the **Replace** field.

4. Enter the new WWN in the **By** field and click **OK**.

The **Replace WWN** dialog box displays. It lists all the zoning elements that include the WWN.

5. Click an item in the list to select or unselect, and click **Replace** to replace the WWN in all the selected zoning elements.

The former WWN is replaced in the Zone Admin buffer by the new WWN, including within any alias or zone in which the old WWN was a member.

Searching for zone members

You can search zone member selection lists for specified strings of text. If you know some identifying information about a possible member of a zoning entity, you can select the tab and view for that entity and then search through its member selection list using the **Search for Zone Member** option. If the target entity is an alias or zone, then the search domain includes elements like switch names and domain numbers, port names and "domain, port" addresses, device WWNs and manufacturer names, and also any aliases that might already have been defined. If the target entity is a configuration, then zones are also included, along with the elements they contain.

The search starts from the top of the list, and when the target element is found, it is also selected in the **Member Selection List** so it can be added or its parent or children can be found. By default, the **Member Selection List** is searched from beginning to end one time. If you select the wraparound option, the search continues to loop from the beginning to the end of the **Member Selection List**.

To search for zone members, perform the following steps.

1. Open the **Zone Administration** window as described in [Opening the Zone Admin window](#) on page 140.
2. Select **Edit > Search Member**.
3. Enter the zone member name in the **Member Name** field.
Optional: Narrow the search by selecting one or more of the check boxes, such as **Match Case**.
4. Click **Next** to begin the zone member search.

Clearing the zoning database

Use the following procedure to disable the active zoning configuration, if one exists, and delete the entire zoning database. You must disable any active configuration before you can delete the zoning database.

ATTENTION

This action not only disables zoning on the fabric, but also deletes the entire zoning database. This results in all devices being able to communicate with each other.

To clear the zone database, perform the following steps.

1. Open the **Zone Administration** window as described in [Opening the Zone Admin window](#) on page 140.
2. Select **Actions > Clear All**.
The **Disable Config** wizard displays.
3. Click **Yes** to do all of the following in the wizard:
 - Disable the current configuration.
 - Clear the entire contents of the current Web Tools Zone Admin buffer.
 - Delete the entire persistent contents of the fabric zoning database.

The wizard allows you to define one and only one name for each device port (WWN). Devices with one or more aliases are considered already named and are not displayed.

Zone configuration analysis

You must use Brocade Network Advisor to analyze the following zone configurations:

- Add unzoned devices
- Remove offline or inaccessible devices
- Replace offline devices
- Define device alias

Best practices for zoning

The following are recommendations for using zoning:

- Always zone using the latest Fabric OS-level switch.
Switches with earlier Fabric OS versions do not have the capability to view all the functionality that a newer Fabric OS provides as functionality is backwards-compatible but not forward-compatible.
- Zone using the core switch versus an edge switch.
- Zone using a director over a switch.
A director has more resources to handle zoning changes and implementations.
- Zone on the switch you connect to when bringing up Web Tools (the proxy switch).

Working with Diagnostic Features

- [Trace dumps](#)..... 159
- [Displaying switch information](#)..... 161
- [Defining switch policy](#)..... 165
- [Port LED interpretation](#)..... 166

Trace dumps

A trace dump is a snapshot of the running behavior within the Brocade switch. The dump can be used by developers and troubleshooters at Brocade to help understand what might be contributing to a specific switch behavior when certain internal events are seen. For example, a trace dump can be created each time a certain error message is logged to the system error log. Developers can then examine what led up to the message event by studying the traces.

Tracing is always "on." As software on the switch executes, the trace information is placed into a circular buffer in system RAM. Periodically, the trace buffer is "frozen" and saved. This saved information is a "trace dump."

A trace dump is generated when:

- It is triggered manually (use the **traceDump** command).
- A critical-level LOG message occurs.
- A particular LOG message occurs (use the **traceTrig** command to set up the conditions for this).
- A kernel panic occurs.
- The hardware watchdog timer expires.

For information about the **traceDump** and **traceTrig** commands, refer to the *Fabric OS Command Reference*.

The trace dump is maintained on the switch until either it is uploaded to the FTP host or another trace dump is generated. If another trace dump is generated before the previous one is uploaded, the previous dump is overwritten.

When a trace dump is generated, it is automatically uploaded to an FTP host if automatic FTP uploading is enabled.

Using the **Trace** tab of the **Switch Administration** window, you can view and configure the trace FTP host target and enable or disable automatic trace uploads.

How a trace dump is used

The generation of a trace dump causes a CRITICAL message to be logged to the system error log. When a trace dump is detected, issue the **supportSave** command on the affected switch. This command packages all error logs, the **supportShow** output, and trace dump, and moves these to your FTP server. You can also configure your switch to automatically copy trace dumps to your FTP server (refer to [Setting up automatic trace dump transfers](#) on page 160).

In addition to automatic generation of trace dumps on faults, you can also generate a trace dump manually or when certain system error messages are logged. This is normally done with assistance from Brocade customer support when diagnosing switch behavior.

For details on the commands, refer to the *Fabric OS Command Reference*.

Setting up automatic trace dump transfers

You can set up a switch so that diagnostic information is transferred automatically to a remote server. Then, if a problem occurs you can provide your customer support representative with the most detailed information possible. To ensure the best service, you should set up for automatic transfer as part of standard switch configuration, before a problem occurs.

Setting up for automatic transfer of diagnostic files involves the following tasks:

- Specifying a remote server to store the files.
- Enabling the automatic transfer of trace dumps to the server. (Trace dumps overwrite each other by default; sending them to a server preserves information that would otherwise be lost.)

Specifying a remote server

The switch must belong to your current Admin Domain before you can perform this task.

To specify a remote server, perform the following steps.

1. Open the **Switch Administration** window.
2. Click **Show Advanced Mode**, if it is not selected.
3. Select the **Trace** tab.
4. Enter the FTP host IP address, path of the remote directory for the trace dump files, FTP user name, and FTP password in the appropriate fields.

The IP address can be IPv4 or IPv6 format, or a DNS name.

The default path for Windows is *Folder Name\FileName.txt* or *FileName.txt*.

The default path for Linux is *Directory Name\FileName.txt* or *FileName.txt*.

The password is optional if you log in as an anonymous user.

5. Click **Apply**.

Enabling automatic transfer of trace dumps

The switch must belong to your current Admin Domain before you can perform this task.

To enable the automatic transfer of trace dumps, perform the following steps.

1. Open the **Switch Administration** window.
2. Click **Show Advanced Mode**, if it is not selected.
3. Select the **Trace** tab.
4. Select **Enable** in the **Auto FTP Upload** section to enable automatic uploading of the trace dump to the FTP host.
5. Click **Apply**.

Disabling automatic trace uploads

If automatic uploading of a trace dump is disabled, you must manually upload the trace dump or else the information is overwritten when a subsequent trace dump is generated.

The switch must belong to your current Admin Domain before you can perform this task.

To disable automatic trace uploads, perform the following steps.

1. Open the **Switch Administration** window.
2. Click **Show Advanced Mode**, if it is not selected.
3. Select the **Trace** tab.
4. Select **Disable** in the **Auto FTP Upload** section to disable automatic uploading of the trace dump to the FTP host.
5. Click **Apply**.

Displaying switch information

You can right-click in the table content of **Fan**, **Temperature**, and **Power Status** windows to find Export, Copy, and Search options. These options are not available if the table does not have any content.

- Click **Export Row** or **Export Table** to save the contents to a tab-delimited file.
- Click **Copy Row** or **Copy Table** to copy the contents in tab-delimited text format to a file.
- Click **Search** to search for a specific text string in the table.

NOTE

You must accept the Brocade Certificate at the beginning of the login to Web Tools to enable the functionality of Export and Copy.

Enter the text string in the box that displays on the table, as shown in the following figure, and press **Enter**. This is an incremental search and allows 24 maximum characters including wildcards question mark (?) and asterisk (*). The first row containing the text string is highlighted. To find the next match, click the down arrow. To find the previous match, click the up arrow. If the text is not found in the table, the text turns red.

FIGURE 28 Temperature Sensor States window

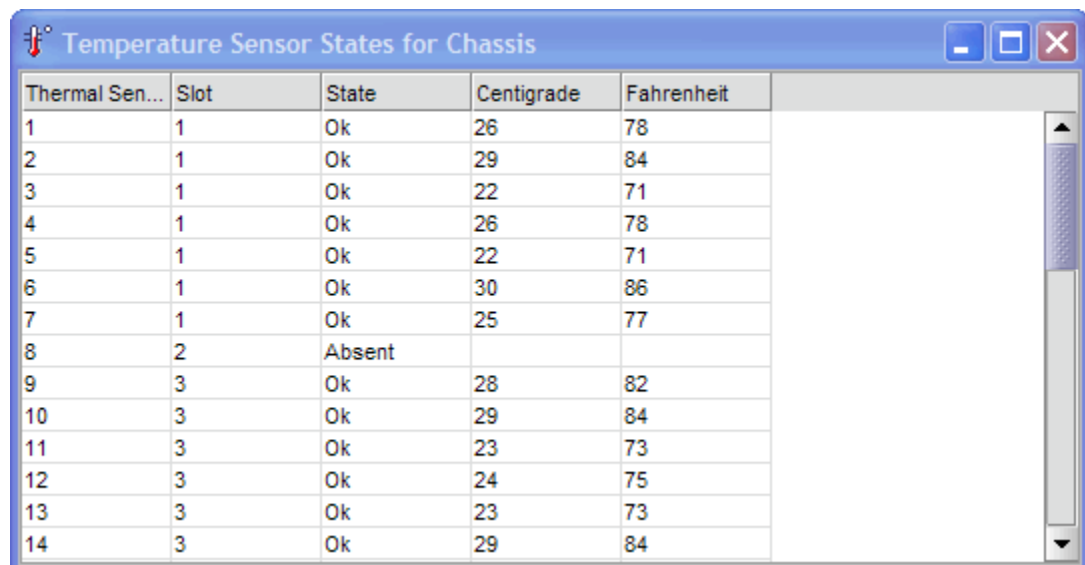

Thermal Sen...	Slot	State	Centigrade	Fahrenheit
1	1	Ok	26	78
2	1	Ok	29	84
3	1	Ok	22	71
4	1	Ok	26	78
5	1	Ok	22	71
6	1	Ok	30	86
7	1	Ok	25	77
8	2	Absent		
9	3	Ok	28	82
10	3	Ok	29	84
11	3	Ok	23	73
12	3	Ok	24	75
13	3	Ok	23	73
14	3	Ok	29	84

Viewing detailed fan hardware status

The icon on the **Fan** button indicates the overall status of the fans. For more information about the switch fan, refer to the appropriate hardware documentation.

You can display status information about the fans, as shown in the following figure.

FIGURE 29 Fan States window

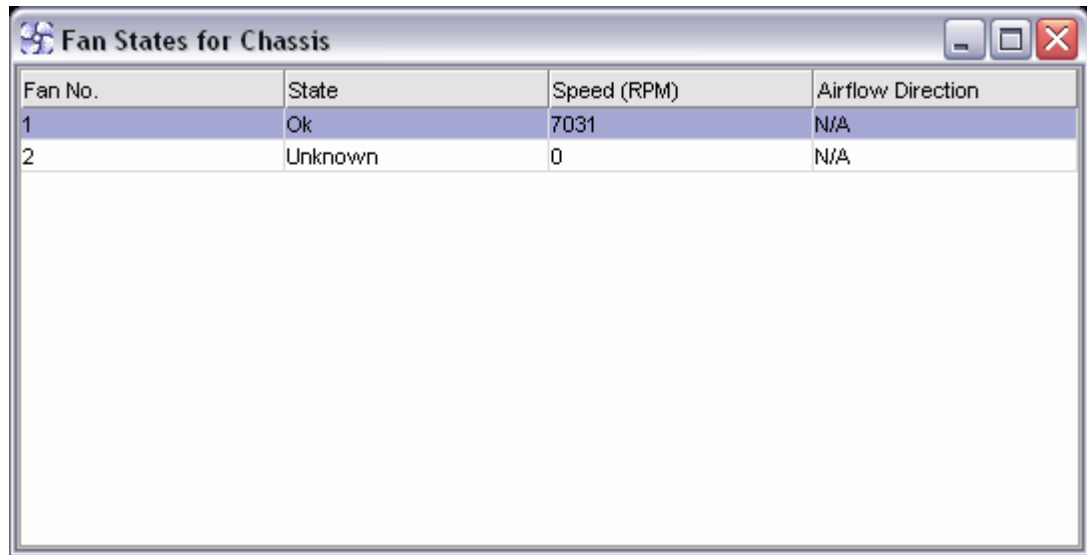

Fan No.	State	Speed (RPM)	Airflow Direction
1	Ok	7031	N/A
2	Unknown	0	N/A

The **Fan No** column indicates either the fan number or the fan FRU number, depending on the switch model. A fan FRU can contain one or more fans. The **Fan No** column indicates the fan FRU number when it is available, otherwise it displays the fan number.

The **AirFlow Direction** column displays the direction state as either **Forward** or **Backward** for the Brocade 6510 and Brocade 6520. For all other hardware, the displayed value will be **N/A**.

NOTE

If the Fan States window has no "Fan Speed" column, *the speed is not monitored*

To view the detailed fan status of a switch, perform the following steps.

1. Select a logical switch from the **Logical Switch** list in the top-right corner of the **Switch Explorer** window.

The selected switch displays in the **Switch View**. The icon on the **Fan** button indicates the overall status of the fan.

2. Click the **Fan** button.

The detailed fan status for the switch displays, as shown in the previous figure.

Viewing the temperature status

The icon on the **Temp** button indicates the overall status of the temperature. For more information regarding switch temperature, refer to the appropriate hardware documentation.

To view the temperature status, perform the following steps.

1. Select a logical switch from the **Logical Switch** list in the top-right corner of the **Switch Explorer** window.

The selected switch displays in the **Switch View** . The icon on the **Temp** button indicates the overall status of the temperature.

2. Click **Temp** on the **Switch View** .

The detailed temperature sensor states for the switch are displayed, as shown in [Displaying switch information](#) on page 161.

Viewing the power supply status

The icon on the **Power** button indicates the overall status of the power supply status. For more information regarding switch power modules, refer to the appropriate hardware documentation.

FIGURE 30 Power States window

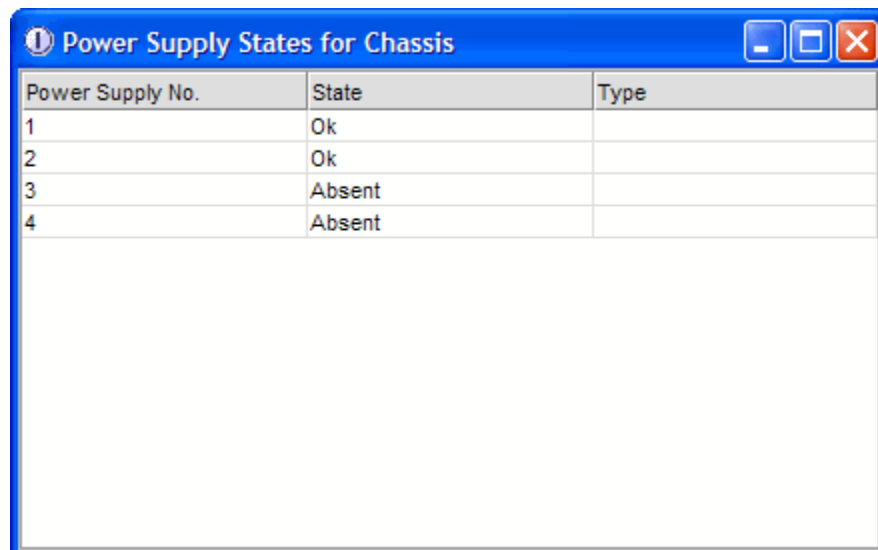

Power Supply No.	State	Type
1	Ok	
2	Ok	
3	Absent	
4	Absent	

To view the power supply status, perform the following steps.

1. Select a logical switch from the **Logical Switch** list in the top-right corner of the **Switch Explorer** window.
2. The selected switch displays in the **Switch View**. The icon on the **Power** button indicates the overall status of the power supply.
3. Click **Power** on the **Switch View**. The detailed power supply states are displayed in the previous figure. If you are using the Brocade 6510 or Brocade 6520, the **Type** column displays either **AC** or **DC**. For all other hardware the value will be **N/A**.

Checking the physical health of a switch

The **Status** button displays the operational state of the switch. The icon on the button displays the real-time status of the switch.

If no data is available from a switch, the most recent background color remains displayed.

Any error-based status message that is based on a per-time interval cause the status to show faulty until the entire sample interval has passed.

If the switch status is marginal or critical, information on the trigger that caused that status displays in the **Switch Information** view.

Click the **Status** button to display a detailed, customizable switch status report, shown in the following figure. Note that this is a static report and not a dynamic view of the switch.

FIGURE 31 Switch Report window

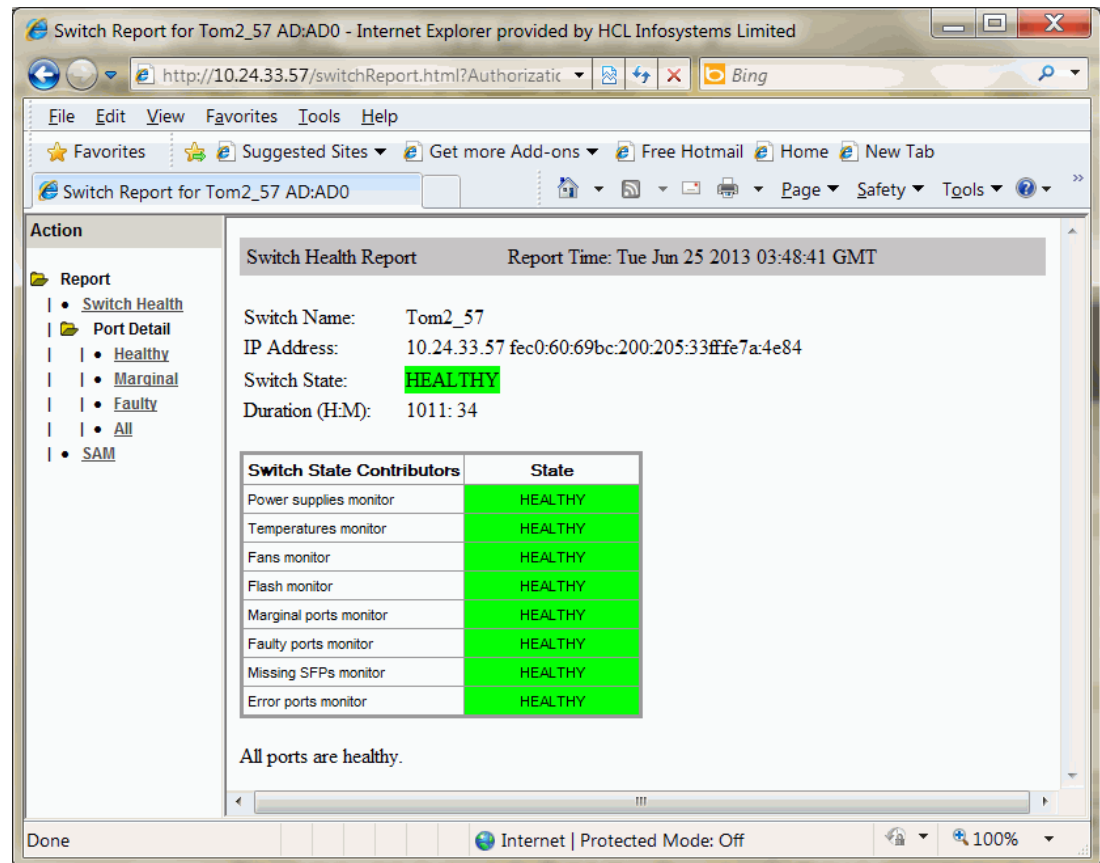

To check the physical health of the switch, perform the following steps.

1. Select a logical switch from the **Logical Switch** list in the top-right corner of the **Switch Explorer** window.

The selected switch displays in the **Switch View**. The icon on the **Status** button indicates the overall status of the switch.

2. Click **Status** on the **Switch View**.

The detailed switch health report displays, as shown in the previous figure.

3. Optional: Click the underlined links in the left panel to display detailed information about ports and Switch Availability Monitoring (SAM).

NOTE

You must have the Fabric Watch or Fabric Vision license to view the Port Detail Report. The Port Detail Report and Switch Availability Monitor (SAM) reports display the details of only those ports that are members of the current Admin Domain context and the E_Ports of the switch.

4. Optional: Hold the pointer on the **Action** bar and click an action to perform one of the following options:

- Refresh the information displayed in the report
- Customize the report
- View the data in raw XML format
- View the style sheet for the report
- View the XML schema for the report

Defining switch policy

The **Switch Status Policy** dialog box lets you define the values for what you consider a healthy switch. The parameters for Switch Policy define whether the unit is listed as being "Healthy", "Marginal", or "Down".

Use this dialog box to set policy parameters for calculating the overall status of the switch. The policy parameter values determine how many failed or faulty units of each contributor are allowed before triggering a status change in the switch from "Healthy" to "Marginal" or "Down". The existence of policies such as WWN, CP, and Blade might differ from platform to platform. Numerical and percentage values that are above "Marginal" are considered to be "Healthy."

Any single contributor can force the overall status of the switch to "Marginal" or "Down". For example, assuming that the switch contributor values are set to the default values, if there is one faulty port in a switch, then this contributor would set the overall switch status to "Marginal". If two ports were faulty, then this contributor would set the overall switch status to "Down".

Percentages are configured from a maximum of 100 percent. For example, setting the **Marginal** value to 6 means the percentage is 94 percent and up; setting the **Marginal** value to 12 means the percentage is 88 percent and up.

NOTE

Entering the value zero (0) for a parameter means that it is *not* used in the calculation. In addition, if the range of configurable values in the prompt is zero (0..0), the policy parameter is *not* applicable to the switch.

To define the Switch Status Policy, perform the following steps.

1. Open the Web Tools main page.
2. Click **Configure** > **Switch Status Policy**.

The **Switch Status Policy** dialog box displays.

NOTE

The options available in the dialog box may differ, depending on the options available on your switch, including CP, core blades, blades, and WWN.

FIGURE 32 Switch Status Policy dialog box

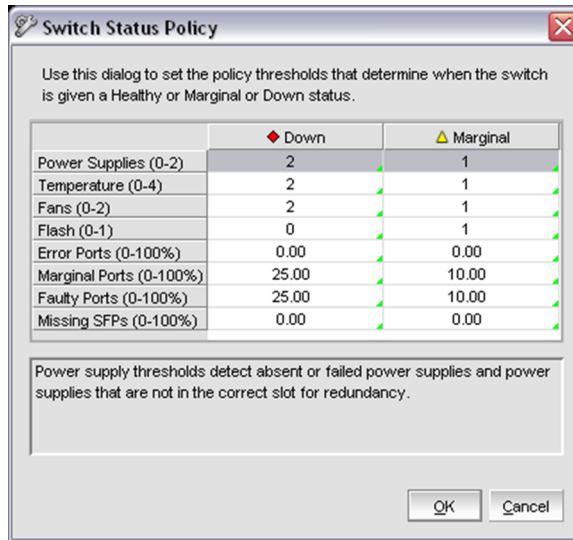

3. Configure the numerical and percentage values to conform to your definition of a healthy switch.
For the selected row, the corresponding field description is displayed in the panel underneath.
4. Optional: Right-click a row in the table to access options to copy the values to your clipboard, or to export the values to a file.
5. Click **OK**.

Port LED interpretation

The [Switch View](#) on page 41 displays port graphics with blinking LEDs, simulating the physical appearance of the ports. One of the LEDs indicates port status; the other indicates port speed. For LED information, refer to the hardware documentation for the switch you are viewing. (The blink rate of the LEDs in the **Switch View** does not necessarily match the blink rate of the LEDs on the physical switch.)

NOTE

All 8 Gbps and 16 Gbps Brocade switches and port blades do not have port speed LEDs, but only port status LEDs.

Port icon colors

The background color of the port icon indicates the port status, as follows:

- Green (healthy)
- Yellow (marginal)
- Red (critical)
- Gray (unmonitored)
- Blue (buffer-limited)
- Dimmed (unlicensed)

Using the FC-FC Routing Service

- [Fibre Channel Routing overview](#)..... 167
- [Supported switches for Fibre Channel Routing](#)..... 168
- [Setting up FC-FC routing](#)..... 168
- [FC-FC routing management](#)..... 169
- [Viewing EX_Ports](#)..... 170
- [Configuring an EX_Port](#)..... 171
- [Configuring FCR router port cost](#)..... 172
- [Viewing LSAN zones](#)..... 172
- [Configuring the backbone fabric ID](#)..... 173

Fibre Channel Routing overview

Fibre Channel Routing (FCR) provides connectivity to devices in different fabrics without merging the fabrics.

For example, Fibre Channel Routing allows you to share tape drives across multiple fabrics without the administrative problems, such as change management, network management, scalability, reliability, availability, and serviceability that might result from merging the fabrics.

Fibre Channel Routing lets you create logical storage area networks (LSANs) that can span fabrics. These LSANs allow Fibre Channel zones to cross physical SAN boundaries without merging the fabrics while maintaining the access controls of zones.

Note the following terminology for Fibre Channel Routing:

backbone fabric	An FC Router can connect two edge fabrics; a backbone fabric connects FC Routers. The FC Router fabric is the backbone fabric. A backbone fabric consists of at least one FC Router and possibly a number of Fabric OS-based Fibre Channel switches. Initiators and targets in the edge fabric can communicate with devices in the backbone fabric through the FC Router.
edge fabric	A standard Fibre Channel fabric with targets and initiators connected through an FC Router to another Fibre Channel fabric.
EX_Port	A type of port that functions somewhat like an E_Port, but does not propagate fabric services or routing topology information from one fabric to another.
FC Router	A switch running FC-FC Routing Service.
interfabric link (IFL)	The link between an E_Port and an EX_Port, or a VE_Port and a VEX_Port.
metaSAN	The collection of all SANs interconnected with FC Routers.
VEX_Port	A virtual port that enables routing functionality through an FCIP tunnel. A VEX_Port is similar to an EX_Port.

A device is shared between:

- The backbone fabric and edge fabric 1
- Edge fabric 1 and edge fabric 2
- Edge fabric 2 and edge fabric 3

Supported switches for Fibre Channel Routing

The FC-FC Routing Service is supported only on the following switch models:

- Brocade VA-40FC
- Brocade 6510
- Brocade 6520
- Brocade 5100 and 5300 switches
- Brocade 7800 Extension Switch
- Brocade 7840 Extension Switch
- Brocade DCX and DCX-4S enterprise-class platforms, when configured with FC8-16, FC8-32, FC8-48, FC8-64, FS8-18, or FX8-24 blades.
- Brocade DCX 8510-4 and DCX 8510-8, when configured with FS8-18, FX8-24, FC8-64, FC8-32E, FC8-48E, FC16-32, FC16-48, FC16-64 blades or CR16-8 blades.

Setting up FC-FC routing

The following procedure provides the basic steps for setting up FC-FC Routing using an FC Router.

1. Ensure that the backbone fabric ID of the FC Router is the same as that of other FC Routers in the backbone fabric. Refer to [Configuring the backbone fabric ID](#) on page 173.
2. On the FC Router, ensure that the ports to be configured as EX_Ports are either not connected or are disabled.
3. Configure EX-Ports by clicking the **EX_Ports** tab and then clicking **New**.
Follow the instructions in the wizard. Refer to [Viewing EX_Ports](#) on page 170.
4. Connect the cables from the EX_Ports on the FC Router to the edge fabrics, if they were not connected before.

NOTE

For a multi-FC Router backbone fabric, make sure that each FC Router is connected to a switch in the backbone fabric.

5. Configure LSAN zones on the fabrics that share devices.
Refer to [Viewing LSAN zones](#) on page 172.
6. View the information in the **EX-Ports**, **LSAN Fabrics**, **LSAN Zones**, and **LSAN Devices** tabs to make sure that your configuration succeeded.

FC-FC routing management

You can perform Fibre Channel Routing operations using Web Tools, Web Tools with the EGM license, and Integrated Routing license. You can manage FC-FC Routing through the FC Routing module. The FC Routing module has tabbed panes that display EX-Ports, LSAN fabrics, LSAN zones, LSAN devices, and general FCR information.

NOTE

In Fabric OS 7.0.1, Integrated Routing (IR) license is not required to configure a port as EX_Port with Network OS mode.

The FC Routing module provides a dynamic display. Any changes in the FCR configuration on the switch are automatically updated in the FC Routing module within 30 to 90 seconds, depending on the network traffic. The last refresh time is displayed in the lower-left corner of the subtabs.

The switch must be FC Router-capable, as described in [Fibre Channel Routing overview](#) on page 167.

You need to configure only EX_Ports and the backbone fabric ID on the FC Router. You can configure LSAN zones on the fabrics from where devices need to be shared. You can configure LSAN zones on the backbone fabric to allow edge fabrics to share devices in the backbone fabric.

To modify the data, you must log in as switchadmin, fabricadmin, basicswitchadmin, operator, or any user-defined role configured with modify rights. If you log in as user, zoneadmin, or securityadmin, you can only view the data.

If the FC-FC Routing service is disabled, the LSAN zones, LSAN fabric, and devices tabs continue to display the existing entries, but display the entries related to the backbone fabric only. All of the EX_Ports are disabled and you cannot enable them until FC-FC routing is enabled.

Opening the FC Routing module

The **FCR** submenu under **Configure** launches the FC Routing module. This module is displayed only for the following switches:

- Brocade VA-40FC
- Brocade 6510
- Brocade 6520
- Brocade 5100 and 5300 switches, 7800 Extension Switch, and the 7840 Extension Switch
- Brocade DCX, DCX-4S and DCX 8510 enterprise-class platforms, when configured with FC8-16, FX8-24, FC8-32, FC8-48, FC8-64, FC16-32, FC16-48 or FC16-64 blades
- Brocade DCX 8510-4 and DCX 8510-8, when configured with FC8-16, FC8-32, FC8-48, FC8-64, FC8-32E, FC8-48E, or CR16-8 blades

NOTE

When the Virtual Fabrics capability is enabled on the switch, Fabric ID cannot be set using the **Set Fabric ID** button.

To open the FC Routing module, perform the following steps.

1. Select a logical switch from the **Logical Switch** list in the top-right corner of the **Switch Explorer** window.

The selected switch displays in the **Switch View**.

2. Click **Configure** > **FCR**

The FC Routing module displays. If FC-FC Routing is disabled, a message to that effect displays on all the tabs in the module.

Viewing and managing LSAN fabrics

The **LSAN Fabric** tab displays all the LSAN fabrics visible to your switch, in both a tabular and tree form. (If FC-FC Routing is disabled, the table and tree nodes in this tab are empty and the tree displays only the backbone switch.)

For more detailed information about a specific LSAN fabric, click a fabric name in the table and then click **View Details** in the task bar. You can also click the fabric name in the tree on the left side of the window.

When there is more than one router present in the backbone fabric with different backbone Fabric IDs, the routers with the conflicting IDs are shown in a separate table on the LSAN Fabric tab.

To manage an LSAN fabric, select the fabric to manage and click **Manage LSAN Fabric** in the task bar. A browser window is launched with the following URL:

<http://ip-address-of-lsan-fabric-switch>

For Brocade switches, this launches Web Tools. For non-Brocade fabrics, this launches the Element Manager for that switch.

Viewing EX_Ports

The **EX_Ports** tab displays all of the EX-Ports on the switch, including configuration and status information. The ports are sorted by slot number, and then by row number within each slot. IP address information is displayed in IPv4 and IPv6 formats.

NOTE

To disable FC Routing, you must disable all EX_Ports and VEX_Ports. You cannot enable these ports until FC Routing is enabled.

For more detailed information about a specific port, click a port name in the table, and select **Properties** from the **Actions** list. You can also click the port name in the tree on the left side of the window.

From the **EX_Ports** tab, you can perform the following port management tasks by selecting a port in the table, and then clicking a task in the task bar:

- Configure EX_Ports
- Edit an EX_Port configuration
- Rename an EX_Port
- Swap the Port Index of an EX_Port (described in [Port swapping index](#) on page 110)
- Enable or disable an EX_Port
- Persistently enable or disable an EX_Port
- Enable or disable trunking
- Configure router port cost

ATTENTION

During EX_Port configuration, the port is automatically disabled, and then re-enabled when the changes are applied. Be sure that you do not physically connect a port to a remote fabric before configuring it as an EX_Port; otherwise, the two fabrics merge and you lose the benefit of Fibre Channel Routing.

You can enable or disable multiple ports at one time. Use **Shift** + click and **Ctrl** + click to select multiple ports in the table, and then click one of the enable or disable tasks in the task bar.

You can select multiple ports in the table, but you can select only one port at a time in the tree.

Configuring an EX_Port

NOTE

With Fabric OS v7.0.1, Web Tools supports interoperability between a Fabric OS fabric and a Brocade Network OS fabric through an FC router. You can select this interoperability mode in the FC Port Configuration wizard. From Fabric OS v7.2.0 and later, EX_Ports can be configured on ICL ports (only in the base switch) as well.

To configure an EX_Port, perform the following steps.

1. Select **Configure** > **FCR**.
2. Select the **EX_Ports** tab.
3. Click **New** in the task bar to configure one or more EX_Ports.

This launches the port configuration wizard, which guides you through the port configuration process.

You must specify the Fabric ID and, if configuring an FC port, the speed and long distance mode. You can select any unique fabric ID as long as it is consistent for all EX_Ports that connect to the same edge fabric.

Editing the configuration of an EX_Port

To edit the configuration of an EX_Port, perform the following steps.

1. Select **Configure** > **FCR**.
2. Select the **EX_Ports** tab.
3. Select a port to configure, by clicking the row.
4. Click **Edit Configuration** in the task bar. This launches the port configuration wizard, which guides you through the port configuration process. The current configuration values are displayed in the wizard steps.

NOTE

If you decide to configure a disabled port, the wizard provides the **Enable Port after configuration** check box. If you select this check box, the disabled port is automatically enabled after configuration. If you leave this box cleared, the port remains in the same state after configuration.

Configuring FCR router port cost

In FCR, EX_Ports can be assigned router port cost. The cost of the link is a positive number. The router port path or tunnel path is chosen based on the minimum cost per connection. If multiple paths exist with the same minimum cost, there will be load sharing over these paths. If multiple paths exist where one path costs less than the others, then the lowest cost path is used.

Every link has a default cost. For an EX_Port 1 Gbps, 2 Gbps, 4 Gbps, 8 Gbps, 10 Gbps, and 16 Gbps links, the default cost is 1000. For a VEX_Port, the default cost is 10000. If the cost is set to 0, the default cost are be used for that link.

To configure the FCR router port cost, perform the following steps.

1. Click **Configure** > **FCR**.
2. Click the **EX_Ports** tab.
3. Disable the EX_Port.
4. Click the **Router Port Cost** button.

Viewing LSAN zones

The **LSAN Zones** tab displays all the LSAN zones, in both a tabular and tree form. If FC-FC Routing is disabled, the table and the tree node in this tab display only the LSAN zones present in the backbone fabric.

For more detailed information about a specific LSAN zone, click a zone name in the table and then click the **View Details** button in the task bar. You can also click the zone name in the tree on the left side of the window.

The LSAN matrix is mapping of LSAN Zones with the edge fabric they are going to communicate with. When an LSAN matrix is created in the backbone fabric, only the LSAN zones mapped in the edge fabrics are displayed in the LSAN Zones tab.

Follow the procedure described in [Creating and populating zones](#) on page 148 to create LSAN zones.

Viewing LSAN devices

The **LSAN Devices** tab displays information about the physical and proxy devices and displays these devices in a tree on the left side of the window. (If FC-FC Routing is disabled, the tables and tree nodes in this tab are empty.)

Click the **LSAN Devices** element in the tree to display a count of all the physical and proxy LSAN devices. Note that this count is for all of the LSAN fabrics.

Click the **Physical Devices** or **Proxy Devices** element in the tree to see a detailed list of the physical or proxy devices. Click the device name in the tree for more detailed information about a specific device.

Configuring the backbone fabric ID

Web Tools automatically disables FC-FC Routing before setting the fabric ID. You should manually enable FCR after setting backbone FID. However, you must first disable all of the EX_Ports before you begin this operation. After the fabric ID is changed, you must re-enable these ports.

NOTE

When the Virtual Fabrics capability is enabled on the switch, Fabric ID cannot be set using the **Set Fabric ID** button.

To configure the backbone fabric ID, perform the following steps.

1. Select **Configure > FCR**.
2. Select the **EX_Ports** tab.
3. Select all the EX_Ports in the table, and click **Disable**.
4. Select the **General** tab.
5. Click **Set Fabric ID** in the task bar.

The **Configure Backbone Fabric ID** window displays.

6. Select a fabric ID from the drop-down menu.

NOTE

The fabric ID is a number from 1 through 128. Web Tools warns you if you select a fabric ID that is already in use.

7. Click **OK**.
8. Click **Enable FCR** in the task bar.
9. Select all the EX_Ports in the table, and click **Enable**.

Using the Access Gateway

- Access Gateway overview..... 175
- Viewing Switch Explorer for Access Gateway mode..... 175
- Access Gateway mode 176
- Enabling Access Gateway mode..... 177
- Disabling Access Gateway mode..... 177
- Viewing the Access Gateway settings..... 178
- Port configuration..... 178
- Access Gateway policy modification..... 182
- Enabling the Automatic Port Configuration policy..... 183

Access Gateway overview

Access Gateway is a software feature that allows multiple host bus adapters (HBAs) to access the fabric using fewer physical ports. You can set a switch in Access Gateway mode to transform them into a device management tool that is compatible with different types of fabrics, including Brocade Enterprise OS (EOS), and Cisco-based fabrics.

When a switch is in Access Gateway mode, it is logically transparent to the host and the fabric. Brocade Access Gateway mode allows hosts to access the fabric without increasing the number of switches and simplifies configuration and management in a large fabric by reducing the number of domain IDs and ports.

For detailed descriptions of the Access Gateway, refer to the *Brocade Access Gateway Administrator's Guide*.

NOTE

When Access Gateway mode is enabled on switches managed through Web Tools, only a limited subset of menus and options related to device management are available. A switch in Access Gateway mode is considered a device management tool and not a fabric switch, therefore fabric related options are disabled, fabric management menus are unavailable, and fabric-related service requests are forwarded to the fabric switches.

Viewing Switch Explorer for Access Gateway mode

The Switch Explorer for Access Gateway mode displays as shown in the following figure.

FIGURE 33 Switch Explorer view for Access Gateway mode

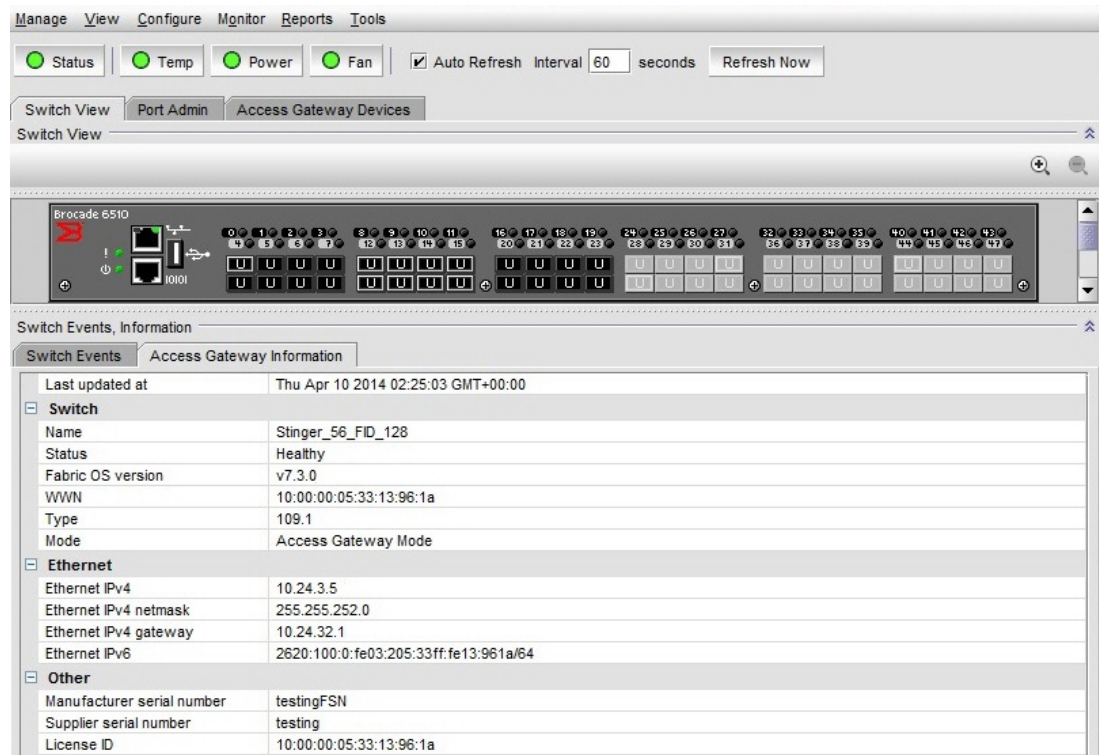

The Access Gateway mode Switch Explorer is divided into the following areas:

- Menu bar
- **Switch View** buttons
- **Switch View**, **Port Admin**, and **Access Gateway Devices** tabs
- **Switch Events** and **Access Gateway** information
- Indicator bar
- Professional Management Tool offering

Access Gateway mode

The Access Gateway feature on the Brocade Encryption switch enables interoperability with the Cisco fabrics. The Access Gateway mode of the switch presents standard F_Ports to the hosts, but it connects to the Enterprise fabric as an N_Port (rather than as an E_Port in the case of a regular switch).

Restricted access in the Port Admin tab

When Access Gateway mode is enabled, the following options can be configured in access gateway mode:

- **Port Configuration Policy** -- You can select Auto or Advanced mode (default mode). When auto mode is selected, options like Configure N-Port Groups, Configure F-N Port Mappings, and N Port configuration are disabled.
- **Trunking** -- You can enable and disable N_Port trunking.
- **Configure N-Port Groups** -- You can configure the port group details from the Port Group Configuration window.
- **Configure F-N Port Mappings** -- Add (right arrow) and Remove (left arrow) buttons are disabled for primary mappings and secondary failover mapping.
- **N Port Configuration** -- By default all the ports are set to N_Ports and failover and fallback are disabled. You can edit the speed. The following options are enabled in the N Port Configuration window:
 - Lock as N Port
 - Allow as F, U Port
 - Enable N Port Failover Policy
 - Enable N Port Fallback Policy

Enabling Access Gateway mode

When you enable Access Gateway mode some fabric information, such as the zone and security databases, is erased. To recover this information, save the switch configuration before enabling Access Gateway mode.

To save the switch configuration using Web Tools, in the **Switch Explorer** window, click **Configure > Switch Admin**, and then select the **Configure > Upload/Download** subtab and upload the configuration file.

You cannot enable Access Gateway mode if Management Server is enabled. To disable Management Server, enter the **MsplmgmtDeactivate** command.

Access Gateway mode is unavailable when VF is enabled.

NOTE

If any error is encountered while enabling the AG mode, the switch gets disabled and remains in the disabled state until you manually enable it.

To enable Access Gateway mode, perform the following steps.

1. Select a switch.
2. Click **Configure > Switch Admin**.
 - The **Switch Administration** dialog box displays.
3. Click **Enable** in the **Access Gateway Mode** section.
4. Click **Apply**.
5. Click **Yes** to restart the switch in Access Gateway mode.

Disabling Access Gateway mode

To disable Access Gateway mode, perform the following steps.

1. Select a switch.
2. Click **Configure** > **Switch Admin**.
The **Switch Administration** dialog box displays.
3. Click **Disable** in the **Access Gateway Mode** section.
4. Click **Apply**.
5. Click **Yes** to restart the device in native switch mode.

Viewing the Access Gateway settings

You can view the effective Access Gateway settings for the selected switch. The view can be customized. To view the Access Gateway settings select the **Access Gateway Devices** tab.

Port configuration

You can configure the port types (N_Port, F_Port) on each individual port on an Access Gateway enabled switch. When you configure ports, you can specify a global configuration policy using the **Port Configuration Policy** button. By default, Advanced is selected and sets the initial defaults for port types, groups, and the F_Port-to-N_Port mappings. When the policy is Automatic, the port type assignments and mappings are configured automatically based on device and switch connections and internal load-balancing and grouping; user controls are disabled.

When you configure ports, perform the tasks in the following order:

1. Configure N_Ports, if necessary. Use the **Port Configuration** wizard to configure a port.
2. Configure N_Port groups.
3. Configure F_Port-to-N_Port mappings. You can set up primary and secondary mappings. The secondary mapping is the N_Port to which an F_Port is mapped when the primary N_Port mapping goes offline.
4. Configure WWN-N_Port mappings

Editing a Port

Editing a port allows you to configure port types, port speed, and ingress rate limit.

With the **Edit** dialog, you can configure allowed port types, port speed, and ingress rate limit for physical ports. To edit a port, perform the following steps.

1. Click a port in the **Switch View** to open the **Port Admin** tab.
2. Select the **FC Ports** tab.
3. Select the port you want to configure from the tree on the left.
4. Select **Edit** from **Actions** list.
The **Edit** dialog displays as shown in the following figure.

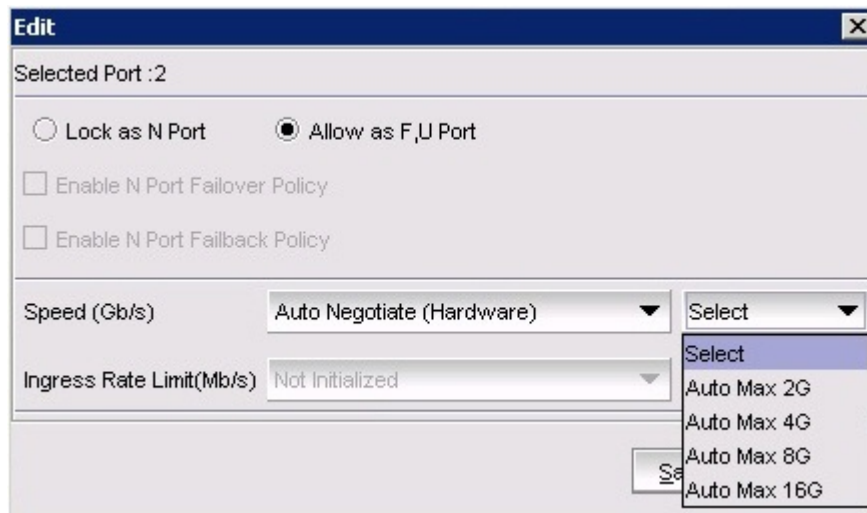
FIGURE 34 Edit dialog

5. Select the port to configure allowed port types, port speed, and ingress rate limit.
6. Click **OK** to save the changes.

NOTE

- Long distance is not displayed from the **Edit** window.
- The Auto Max speed levels are displayed only when you set the port speed as Auto Negotiate and these options allow you to set the speed limit the port can auto-negotiate.

Creating port groups

You can group a number of N_Ports (and its mapped F_Ports) together to connect to multiple independent fabrics or to create performance optimized ports. To group a number of ports, you must create a new port group and assign desired N_Ports to it. The N_Port grouping option is enabled by default, and all N_Ports are members of a default port group 0 (pg0). Access Gateway prevents failover of F_Ports across N_Port groups.

NOTE

If you want to distribute F_Ports among groups, you can leave all ports in the default port group 0, or you can disable N_Port grouping.

To create port groups, perform the following steps.

1. Click a port in the **Switch View** to open the **Port Admin** tab.
2. Select **Advanced** from **Configure > Port Configuration Policy**.
3. Select a port or ports to configure.
4. Select **Configure N-Port Groups** from the **Actions** list.

NOTE

Configure N-Port Groups is unavailable if you select **Automatic** from the **Port Configuration Policy**.

5. In the **Port Group Configuration** dialog box, click **Add**.
The **Add Port Group** window displays.
6. Enter the ID for the new port group in the **Port Group ID*** field.
7. Enter the name for the new port group in the **Port Group Name** field.
8. Select the **Login Balancing** check box to enable login balance for the port group.
9. Select the **Fabric Name Monitoring** check box to manually configure the managed fabric name monitoring.
10. Under the **Select Members(N-Port)*** section, select the required ports you want to group.
11. Click **Save**.

Editing or viewing port groups

To edit port groups, perform the following steps.

1. Click a port in the **Switch View** to open the **Port Admin** tab.
2. Select **Configure N-Port Groups** from the **Actions** list.
3. On the **Port Group Configuration** dialog box, select the group that you want to edit and click **Edit/View**.
The **Edit/View Port Group** window displays.
4. Edit the name of the port group in the **Port Group Name** field.
5. Select the **Login Balancing** check box and the **Fabric Name Monitoring** check box if you want to enable these features. Clear the check boxes to disable these features.
Upon selecting the **Login Balancing** check box, the **F Port Auto Rebalancing** and **N-Port Auto Rebalancing** check boxes and **Manual Balancing** button become enabled.
6. Click **Failover Enable**.
A confirmation dialog box displays.
7. Click **Yes** to enable failover to all the ports in the port group or click **No** if you do not want to enable failover.
8. Click **Failover Disable**.
A confirmation dialog box displays. Click **Yes** to disable failover to all the ports in the port group or click **No** if you do not want to disable failover.
9. Click **Failback Enable**.
A confirmation dialog box displays.
10. Click **Yes** to enable failback to all the ports in the port group or click **No** if you do not want to enable failback.
11. Click **Failback Disable**.
A confirmation dialog box displays. Click **Yes** to disable failback to all the ports in the port group or click **No** if you do not want to disable failback.
12. Under the **Select Members(N-Port)*** section, select the required ports you want to group and clear the check boxes for the ports you want to remove from the port group.
13. Click **Save**.
14. Click **Close** on the **Port Group Configuration** dialog box.

Deleting port groups

NOTE

You cannot delete the default port group 0 (pg0).

To delete port groups, perform the following steps.

1. Click a port in the **Switch View** to open the **Port Admin** tab.
2. Select **Configure N-Port Groups** from the **Actions** list.
3. In the **Port Group Configuration** dialog box, select the group that you want to delete and then click **Delete**. A confirmation dialog box displays.
4. Click **Yes** to confirm the action.

Defining custom primary F-N port mapping

To manually change primary F-N port mappings, perform the following steps.

1. Click a port in the **Switch View** to open the **Port Admin** tab.
2. Click the **FC Ports** tab.
3. Select **Configure F-N Port Mappings** from the **Actions** list.
4. Select the **Primary Mappings** subtab on the right side of the dialog box.
5. In the **Primary Mappings** area, select ports and use the **Add** (right arrow) button to map F_Ports or U_Ports to N_Ports.
6. Optional: Use the **Remove** (left arrow) button to delete an F_Port mapping from an N_Port.
7. Optional: Define a secondary N_Port in the **Secondary Failover Mappings** area, by selecting the ports using the **Add** and **Remove** buttons to set up the secondary mappings.

The secondary mappings must be to a different port in the same group as the primary mapping. If a secondary port is not defined, the failover moves to any online ports within the same port group.

8. After you have made the appropriate changes, click **Save**.

Defining custom static F-N port mapping

In Fabric OS v7.0.0 and later, the **Static F port mapping** and **Static N port mapping** columns have been added to the **Port Admin** GUI to display static mapping information.

NOTE

Static mappings and custom WWN-N port mappings are mutually exclusive.

To manually change static F-N port mappings, perform the following steps.

1. Click a port in the **Switch View** to open the **Port Admin** tab.
2. Click the **FC Ports** tab.
3. Select **Configure F-N Port Mappings** from the **Actions** list.
4. Select the **Static Mappings** subtab on the right side of the dialog box.
5. In the **Primary Mappings** area, select ports and use the **Add** (right arrow) button to map F_Ports or U_Ports to N_Ports.
6. Optional: Use the **Remove** (left arrow) button to delete an F_Port mapping from an N_Port.
7. After you have made the appropriate changes, click **Save**.

Defining custom WWN-N port mappings

NOTE

Static mappings and custom WWN-N port mappings are mutually exclusive.

To manually change WWN-N port mappings, perform the following steps.

1. Select the **Port Admin** tab.
2. Click the **FC Ports** tab.
3. Select **Configure WWN-N Port Mappings** from the **Actions** list.
4. In the **Primary Mappings** area, select a WWN from the left pane and a group or port from the right pane.
5. Click the **Add** (right arrow) button to map the WWN to the port or port group.
6. Optional: Expand the port in the right page and select the WWN and then use the **Remove** (left arrow) to remove the mapping.
7. Optional: Define a failover in the **Secondary Failover Mappings** area, by selecting the ports using the **Add** (right arrow) and **Remove** (left arrow) buttons to set up the secondary mappings.

The WWN fails over to the secondary mapping if the primary mapped port is offline. If a secondary port is not defined, the failover moves to any online ports.

8. Optional: To create a detached WWN-N port mapping, enter the WWN value into the **WWN** field and click **Add**.

The detached WWN port is now available for mapping.

9. After you have made the appropriate changes, click **Save**.

Any unused WWNs are discarded.

Access Gateway policy modification

Although you can control a number of policies on switches in Access Gateway mode, Web Tools only provides the ability to enable and disable the policies. For more information on these policies, please refer to the *Access Gateway Administrator's Guide*.

Path Failover and Failback policies

The Path Failover and Failback policies determine the behavior of the F_Port if the primary mapped N_Port they are mapped to goes offline or is disabled. The Path Failover and Failback policies are attributes of the N_Port. By default, the Path Failover and Failback policies are enabled for all N_Ports.

Modifying Path Failover and Failback policies

To modify Path Failover and Failback policies, perform the following steps.

1. Click a port in the **Switch View** to open the **Port Admin** tab.
2. Select the N_Port for which you want to modify the policy.
3. Select **Edit** from the **Actions** list.

4. Select the appropriate check box to modify the policy.
5. Click **Save**.

Enabling the Automatic Port Configuration policy

The Automatic Port Configuration (APC) policy is a global configuration policy for a switch in Access Gateway mode. By default, this policy is disabled. If you created an N_Port grouping and switching over to the automatic mode, those port groups are lost. After you enable the APC policy, you cannot define custom port type configurations, port mappings, Path Failover, and Failback settings.

NOTE

When port configuration is in auto mode, the **Configure N-Port Groups**, **Configure F-N Port Mappings**, and **Configure WWN-N Port Mappings** options are unavailable.

To enable auto rebalancing from the **Switch Administration** window, perform the following steps.

1. Click a port in the **Switch View** to open the **Port Admin** tab.
2. Select **Automatic** from **Configure** > **Port Configuration Policy**.

NOTE

When **Port Configuration Policy** is set to **Advanced**, you can enable the auto-rebalancing options from the **Configure N-Port Groups** dialog box through the **Port Admin** tab.

3. Click **Yes** in the confirmation window.
4. In the **Switch Explorer** window, click **Configure** > **Switch Admin**. The **Switch Administration** window displays.

FIGURE 35 Access Gateway Auto Rebalancing

The screenshot shows the 'SW300_155 - Switch Administration' web interface. The page title is 'SW300_155 - Switch Administration'. The interface includes a navigation bar with tabs for 'Switch', 'Network', 'Firmware Download', 'License', 'User', and 'Trunking'. The 'Switch' tab is active. The main content area is divided into several sections:

- Switch Name:** Name: SW300_155, Manufacturer Serial #: ALJ0613D04K, Supplier Serial #: none.
- Switch Status:** Enable, Disable.
- DNS Configuration:** DNS Server 1: 10.32.2.10, DNS Server 2: 10.32.2.11, Domain Name: englab.brocade.com. A 'Remove All' button is present.
- Report:** A 'View Report' button.
- Reboot/Fastboot:** 'Reboot' and 'Fastboot' buttons.
- Access Gateway Mode:** Enable, Disable, N Port Auto Rebalancing, F Port Auto Rebalancing, and a 'Manual Balancing' button.

At the bottom right of the main content area are 'Apply', 'Close', and 'Refresh' buttons. A status bar at the bottom of the window shows: 'Change current switch settings | Mode: Basic | Free Professional Management Tool | 10.35.52.155 | User: admin | Role: admin | ✓'. A message at the bottom left of the main content area reads: '[Switch Administration opened]: Thu Jul 09 2009 19:49:21 GMT+00:00'.

5. Click **Refresh**.
6. Under the **Access Gateway Mode** section, do the following:
 - Select the **N Port Auto Rebalancing** check box to enable N_Port rebalancing.
 - Select **F Port Auto Rebalancing** check box to enable F_Port rebalancing.
 - Click **Manual Balancing** and a confirmation dialog box displays. Click **Yes** to change F Port-N Port Mapping or click **No** to cancel the changes.
7. Click **Apply** to apply the changes.

Administering Fabric Watch

- [Fabric Watch overview](#)..... 185

Fabric Watch overview

Fabric Watch is an optional Brocade licensed feature that monitors the performance and status of switches. Fabric Watch can automatically alert you when problems arise, before they become costly failures.

NOTE

If you do not own the switch, Fabric Watch is view-only. Owning ports on a switch is not enough to enable Fabric Watch on that switch. To use Fabric Watch, you must have the Fabric Watch license or Fabric Vision license installed on the switch.

Fabric Watch tracks a number of SAN fabric elements, events, and counters. For example, Fabric Watch monitors the following:

- Fabric resources, including fabric reconfigurations, zoning changes, new logins, domain ID changes, E_Port failures, and segmentation changes
- Switch environmental functions, such as temperature, flash, CPU and memory usage, along with security violations
- Port state transitions, errors, and traffic information for multiple port classes, as well as operational values for supported models of Finisar "Smart" GBICs/SFPs

Fabric Watch lets you define how often to measure each switch and fabric element and allows you to specify notification thresholds. Whenever fabric elements exceed these thresholds, Fabric Watch automatically provides notification using several methods, including e-mail messages, SNMP traps, and log entries.

For detailed information regarding Fabric Watch, refer to the *Fabric Watch Administrator's Guide*.

Administering Extended Fabrics

- [Extended link buffer allocation overview.....](#) 187
- [Configuring a port for long distance.....](#) 189

Extended link buffer allocation overview

If the link is used over long distances, use the **Extended Fabric** tab of the **Switch Administration** window to configure the long-distance setting of a port. Because buffer credits are a switch resource, you must own the switch in order to modify extended fabric settings on a port. The EGM license must be enabled on the switch; otherwise, access to configuring long distance is denied and an error message displays.

The **Extended Fabric** tab displays information about the port speed, long-distance settings, and buffer credits, as shown in the following figure. For detailed information on managing extended fabrics, refer to the *Fabric OS Administrator's Guide*.

The **Extended Fabric** tab displays the following columns:

- **Port Number**
- **Buffer Limited** --Indicates whether the port is buffer limited. A buffer-limited port can come online with fewer buffer credits allocated than its configuration specifies, allowing it to operate at a reduced bandwidth instead of being disabled for lack of buffers.

Buffer-limited operation is supported for the LS and LD extended ISL modes only and is persistent across reboots, switch disabling and enabling, and port disabling and enabling.
- **Port Speed** --The port speed is displayed as follows:
 - 1G--1 Gbps
 - 2G--2 Gbps
 - 4G--4 Gbps
 - 8G--8 Gbps
 - 10G--10 Gbps
 - N1--Negotiated 1 Gbps
 - N2--Negotiated 2 Gbps
 - N4--Negotiated 4 Gbps
 - N8--Negotiated 8 Gbps
 - N16--Negotiated 16 Gbps
 - Auto-Negotiation
- **Buffer Needed** --The number of buffers needed. You can edit the buffer needed for LD and LS modes. When you change **Buffer Needed** value, **Frame Size** and **Desired Distance(km)** value cannot be changed.
- **Buffer Allocated** --The number of buffers actually allocated.
- **Recommended Buffer**-- The number of recommended buffers. The recommended buffer value is non-editable. The default port configuration value displays when the Extended Fabric is launched for the first time. When you change **Frame Size** and **Desired Distance(km)**, the recommended buffer value changes according to the current port configuration. When the number of buffers needed is configured for a port, the recommended buffer value is set to N/A for the same port.

- **Remaining Buffer**--The number of remaining buffers. The remaining buffer value is non-editable. If the **Buffers Needed** value exceeds the remaining buffer value, a warning message displays.
- **Frame Size** --The size of the frame. When you edit the frame size value, the desired distance value can also be changed for LD and LS modes and vice versa. But the buffer value cannot be changed.
- **VC Link Init** --The fill words used on long distance links. When set to IDLE (0) mode, the link uses IDLE fill words. When set to ARB (1) mode, the link uses the default ARB fill words.
- **Fill Word** --Fill word comprises of the following modes:
 - **Mode 0** : Use IDLE in link init and IDLE as Fill word
 - **Mode 1**: Use ARB in link init and ARB as Fill word
 - **Mode 2** : Use IDLE in link init and ARB as Fill word
 - **Mode 3** : Try Mode 1 first; if it fails, then try Mode 2.

NOTE

Fill word is not supported in 16 Gbps capable FC platforms. You must configure **Fill Word** and then **configure Long Distance** and **VC Link Init** . Make sure **Fill Word** is always equal to or greater than the **VC Link Init** value.

- **Link Distance(km)** --The actual distance of the link.
- **Desired Distance (km)** -- Required for a port configured in LD or LS mode (as shown in the following table), the desired distance, in kilometers, for the link.

For an LD-mode link, the desired distance is used as the upper limit of the link distance to calculate buffer availability for other ports in the same port group. If the measured distance is more than the desired distance, the desired distance is used to allocate the buffers. In this case, the port operates in degraded mode instead being disabled due to insufficient buffers.

For an LS-mode link, the actual distance is not measured; instead the desired distance is used to calculate the buffers required for the port.

- **Long Distance** -- The following table describes the long-distance settings and identifies which settings require a Brocade Extended Fabrics license.

FIGURE 36 Extended Fabric tab

Port Number	Buffer Limited	Port Speed	Buffer Needed	Buffer Allocated	Recommended Buffer	Remaining Buffer	Frame Size	VC Link Init	Fillword	Link Distance(km)	Desired Distance(km)	Long Distance
0	No	NS	0	0	26	4960	0	IDLE(0)	N/A	-	N/A	L0 Normal
1	No	NS	0	0	26	4960	0	IDLE(0)	N/A	-	N/A	L0 Normal
2	No	NS	0	0	26	4960	0	IDLE(0)	N/A	-	N/A	L0 Normal
3	No	NS	0	0	26	4960	0	IDLE(0)	N/A	-	N/A	L0 Normal
4	No	NS	0	0	26	4960	0	IDLE(0)	N/A	-	N/A	L0 Normal
5	No	NS	0	0	26	4960	0	IDLE(0)	N/A	-	N/A	L0 Normal
6	No	NS	0	0	26	4960	0	IDLE(0)	N/A	-	N/A	L0 Normal
7	No	NS	0	0	26	4960	0	IDLE(0)	N/A	-	N/A	L0 Normal
8	No	NS	0	0	26	4960	0	IDLE(0)	N/A	-	N/A	L0 Normal
9	No	NS	0	0	26	4960	0	IDLE(0)	N/A	-	N/A	L0 Normal
10	No	NS	0	0	26	4960	0	IDLE(0)	N/A	-	N/A	L0 Normal
11	No	NS	0	0	26	4960	0	IDLE(0)	N/A	-	N/A	L0 Normal
12	No	NS	0	0	26	4960	0	IDLE(0)	N/A	-	N/A	L0 Normal
13	No	NS	0	0	26	4960	0	IDLE(0)	N/A	-	N/A	L0 Normal
14	No	NS	0	0	26	4960	0	IDLE(0)	N/A	-	N/A	L0 Normal
15	No	NS	0	0	26	4960	0	IDLE(0)	N/A	-	N/A	L0 Normal
16	No	NS	0	0	26	4960	0	IDLE(0)	N/A	-	N/A	L0 Normal
17	No	NS	0	0	26	4960	0	IDLE(0)	N/A	-	N/A	L0 Normal
18	No	NS	0	0	26	4960	0	IDLE(0)	N/A	-	N/A	L0 Normal

For the Brocade DCX, DCX-4S, DCX 8510-4, and DCX 8510-8 the slots for CPs are not available.

The Brocade Encryption Switch and the FS8-18 Encryption blade support auto-negotiated link speeds of 1, 2, 4, and 8 Gbps.

TABLE 18 Long-distance settings and license requirements

Value	Description	Extended Fabrics License Required?
L0	No long-distance setting is enabled. The maximum supported link distance is: <ul style="list-style-type: none"> • 10 kilometers at 1 Gbps • 5 kilometers at 2 Gbps • 2.5 kilometers at 4 Gbps • 1 kilometers at 10 Gbps • 500 meters at 16 Gbps 	No
LE	Extended normal setting is enabled, 10 km (6 miles) or less.	No
LD	Dynamic setting is enabled. Buffer credits for the given E_Port are dynamically configured based on the actual link distance, as long as this is less than the desired distance. If the actual link distance exceeds the desired distance, the desired distance is used to allocate the buffers. The LD-level link can operate at distances up to 500 km at 1 Gbps, 250 km at 2 Gbps, or 125 km at 4 Gbps, depending on the switch platform and the availability of frame buffers within the port group.	Yes
LS	Static setting is enabled. Buffer credits for the given E_Port are statically configured based on the desired link distance. The LS-level link can operate at distances up to 500 km at 1 Gbps, 250 km at 2 Gbps, or 125 km at 4 Gbit/sec, depending on the switch platform and the availability of frame buffers within the port group. For the Brocade DCX 8510-8, Brocade 6510, Brocade 6520, and Brocade DCX 8510-4, the buffer credits are 10 through X; where X is proportional to the available buffers.	Yes

Configuring a port for long distance

When you configure a long-distance ISL, ensure that the ports on both sides of the ISL have the same configuration in order to avoid fabric segmentation.

To configure a port for long distance, perform the following steps.

1. Open the **Switch Administration** window as described in [Opening the Switch Administration window](#) on page 52.
2. Click **Show Advanced Mode**.
3. Select the **Extended Fabric** tab.
4. This step is switch-specific:

For the Brocade DCX 8510-8, Brocade DCX 8510-4, DCX, and DCX-4S platforms, click the slot subtab that corresponds to the correct slot for the logical switch.

For the Brocade 300, 5100, 5300, VA-40FC, 6505, 6510, 6520, 7800 Extension Switch, 7840 Extension Switch, and the Encryption Switch, proceed to the next step.

5. Select a distance that corresponds to the port from the **Long Distance** menu.

Depending on the distance selected, this might require a license. For information about the various distances, refer to [Table 18](#) on page 189.

If you select a long-distance setting of LD or LS, you must also enter a value in the **Desired Distance** column for that port number. For LD or LS options, the **Buffer Needed** column is made editable to specify the buffer needed value. On changing the buffer needed value, the **Frame Size** and **Desired Distance** values cannot be changed.

- a) Double-click the **Desired Distance** field for the port, as shown in [Figure 36](#) on page 188.
- b) Enter a number in the field to indicate the distance in kilometers. The allowed values depend on the port capability:
 - If the port capability is 8 GB, type a number between 10 and 63 inclusive.
 - If the port capability is 4 GB, type a number between 10 and 125, inclusive.
 - If the port capability is 2 GB, type a number between 10 and 250, inclusive.
 - If the port capability is 1 GB, type a number between 10 and 500, inclusive.
 - For the Brocade 6510, Brocade 6520, Brocade DCX 8510-8 and Brocade DCX 8510-4, the buffer credits are 10 through X; where X is proportional to the available buffers.

This value is the upper limit for calculating buffer availability for other ports in the same port group. If the actual distance is more than the desired distance, the port operates in buffer-limited mode.
- c) Press **Enter** or click another port entry for the value to be accepted.

6. Click **Apply**.

7. Click **Yes** to apply the changes, or click **No** to close the confirmation message window.

Routing Traffic

- Routing overview..... 191
- Viewing fabric shortest path first routing..... 192
- Configuring dynamic load sharing..... 193
- Specifying frame order delivery..... 194
- Configuring the link cost for a port..... 194

Routing overview

NOTE

To perform routing operations and Dynamic Load Sharing (DLS) configurations, the EGM license must be installed on the switch; otherwise, access to these features is denied and an error message displays.

For Fabric OS v7.0.0 and later, the supported routing policies are:

- Port-based routing -- Port-based routing assigns a "static route," in which the path chosen for traffic never changes.
- Exchange-based routing -- Exchange-based routing policy is the default. Exchange-based routing policy always employs "dynamic path selection," in which the software defines a path based on current traffic conditions.
- Device-based routing -- Device-Based Routing (DBR) is a read-only option. If DBR is set in the switch, then the DBR radio button appears auto-selected and is unavailable in Web Tools.

Refer to the *Fabric OS Administrator's Guide* for more information.

To optimize port-based routing, the DLS can be enabled to balance the load across the available output ports within a domain. Exchange-based routing *requires* the use of DLS; when this policy is in effect, you cannot disable the DLS feature.

Use the **Routing** tab of the **Switch Administration** window to view and modify routing information. The following figure displays the **Routing** tab.

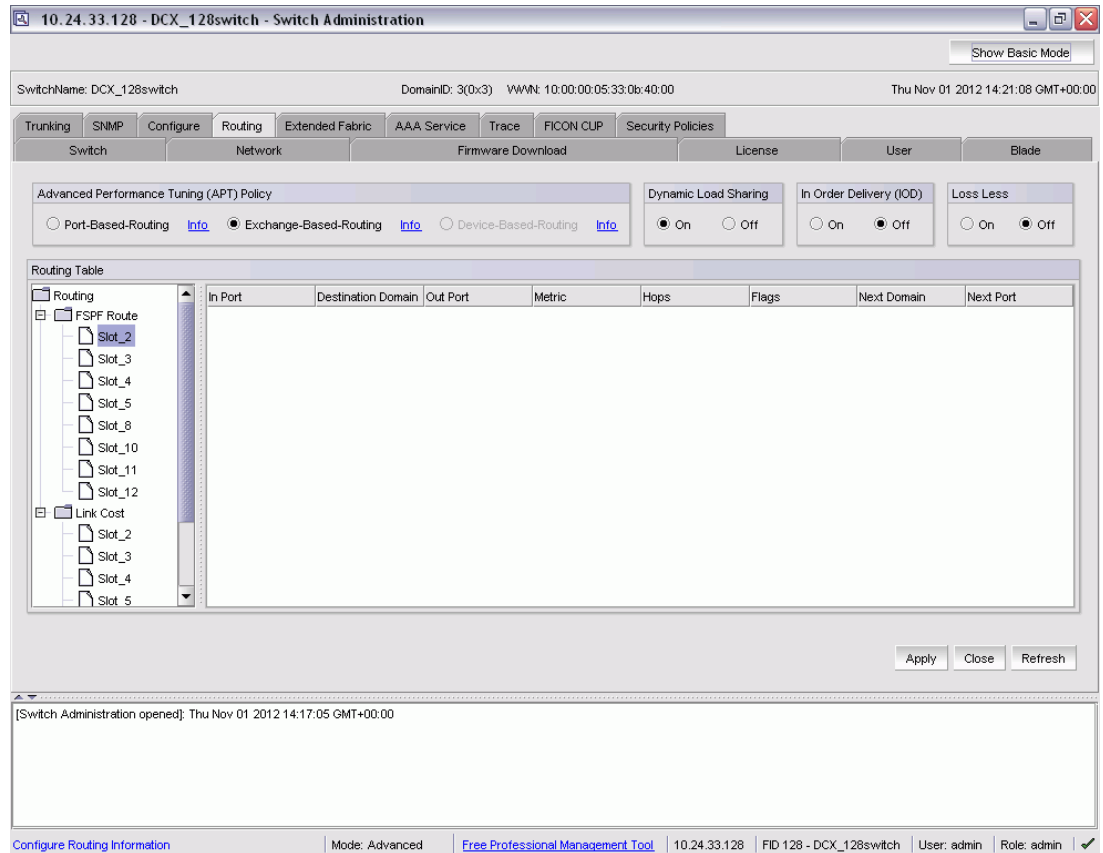
FIGURE 37 Routing tab

Viewing fabric shortest path first routing

The **Routing** tab of the **Switch Administration** window displays information about routing paths.

To view the fabric shortest path first routing, perform the following steps.

1. Open the **Switch Administration** window as described in [Opening the Switch Administration window](#) on page 52.
2. Select the **Routing** tab.
3. This step is switch-type specific:
 - For the Brocade DCX 8510-8, DCX 8510-4, DCX or DCX-4S enterprise-class platforms, click a slot number under the FSPF Route category in the navigation tree.
 - For the Brocade 300, 5100, 5300, 6505, 6510, 6520, 7800 Extension switch, VA-40FC, and the Encryption Switch, click the FSPF Route category in the navigation tree.

Configuring dynamic load sharing

The exchange-based routing policy depends on the Fabric OS Dynamic Load Sharing feature (DLS) feature for dynamic routing path selection. When this policy is in force, DLS is always enabled and cannot be disabled.

When the port-based policy is in force, you can enable DLS to optimize routing. When DLS is enabled, it shares traffic among multiple equivalent paths between switches. DLS recomputes load sharing either when a switch boots up or each time an E_Port or FX_Port goes online or offline. Enabling this feature allows a path to be discovered automatically by the FSPF path-selection protocol.

For more information regarding DLS, refer to the **dlisset** command in the *Fabric OS Command Reference*.

To configure dynamic load sharing, perform the following steps.

1. Open the **Switch Administration** window as described in [Opening the Switch Administration window](#) on page 52.
2. Select the **Routing** tab.
3. Select **On** in the **Dynamic Load Sharing (DLS)** area to enable dynamic load sharing or select **Off** to disable dynamic load sharing.

When the exchange-based routing policy is in effect, the DLS radio buttons display on the **Routing** tab

4. Click **Apply**.

The warning message, "Credit Recovery for Long distance links should be turned off using CLI while enabling DLS" displays.

5. Click **OK**.

Lossless dynamic load sharing

Lossless dynamic load sharing (DLS) is supported in following platforms:

- Brocade 300
- Brocade 5100
- Brocade 5300
- Brocade 6505
- Brocade 6510
- Brocade 6520
- Brocade 7800 on FC ports
- Brocade 7840 on FC ports
- Brocade DCX 8510-4 Backbone
- Brocade DCX 8510-8 Backbone
- Brocade DCX Backbone
- Brocade DCX-4S Backbone

NOTE

For the Brocade FX8-24 Extension blade, lossless feature is supported only on FC ports.

You can enable this lossless feature from Web Tools. If you try to enable lossless when DLS is off, an error message displays.

To enable or disable lossless DLS, perform the following steps.

1. Open the **Switch Administration** window as described in [Opening the Switch Administration window](#) on page 52.
2. Select the **Routing** tab.
3. Select **On** in the **Loss Less** area to enable the mode, or select **Off** to disable dynamic load sharing.
When the exchange-based routing policy is in effect, the Lossless DLS buttons display on the **Routing** tab.
4. Click **Apply**, and then click **OK**.

Specifying frame order delivery

In a stable fabric, frames are always delivered in order, even when the traffic between switches is shared among multiple paths. However, when topology changes occur in the fabric (for example, if a link goes down), traffic is rerouted around the failure, and some frames could be delivered out of order.

By default, frame delivery is out-of-order across topology changes. However, if the fabric contains destination devices that do not support out-of-order delivery, you can force in-order frame delivery across topology changes.

Enabling in-order delivery (IOD) guarantees that frames are either delivered in order or dropped. For more information regarding IOD, refer to the *Fabric OS Administrator's Guide*.

NOTE

Enabling in-order delivery can cause a delay in the establishment of a new path when a topology change occurs, and therefore should be used with care.

To specify frame order delivery, perform the following steps.

1. Open the **Switch Administration** window as described in [Opening the Switch Administration window](#) on page 52.
2. Select the **Routing** tab.
3. Click **On** in the In Order Delivery (IOD) area to force in-order frame delivery across topology changes or click **Off** to restore out-of-order frame delivery across topology changes.
4. Click **Apply**.

Configuring the link cost for a port

This section describes how to set the cost of an interswitch link (ISL). The cost of a link is a dimensionless positive number. The fabric shortest path first (FSPF) protocol compares the cost of various paths between a source switch and a destination switch by adding the costs of all the ISLs along each path. FSPF defines the path with minimum cost. If multiple paths exist with the same minimum cost, FSPF employs load sharing over these paths.

Every ISL has a default cost that is inversely proportional to its bandwidth.

Use this procedure to set a non-default, "static" cost for any port.

1. Open the **Switch Administration** window as described in [Opening the Switch Administration window](#) on page 52.
2. Select the **Routing** tab.
3. This step is switch-specific:

- For the Brocade DCX, DCX-4S, DCX 8510-8, and DCX 8510-4 enterprise-class platforms, click the slot number of the logical switch under **Link Cost** in the navigation tree.
 - For Brocade 300, 5100, 5300, 6505, 6510, 6520, 7800, 7840, VA-40FC, and the Encryption Switch, click **Link Cost** in the navigation tree.
4. Double-click in the row in the **Cost** column that corresponds to the appropriate port.
 5. Enter the link cost. Valid values for link cost are from 1 through 65534. Setting the value to 0 sets the link cost to the default value for that port.
 6. Click **Apply**.

Configuring Standard Security Features

- User-defined accounts..... 197
- User-defined roles..... 206
- Access control list policy configuration..... 209
- Fabric-Wide Consistency Policy configuration..... 212
- Authentication policy configuration..... 213
- SNMP configuration..... 215
- RADIUS management..... 217
- Active Directory service management..... 220
- TACACS+ management..... 221
- IPsec concepts..... 223
- IPsec over management ports..... 228
- Establishing authentication policies for HBAs..... 233

User-defined accounts

In addition to the default accounts--root, factory, admin, and user--Fabric OS v7.0.0 and later support up to 256 user-defined accounts in each logical switch (domain). These accounts expand your ability to track account access and audit administrative activities.

When the Virtual Fabrics capability is enabled, each user-defined account is associated with the following:

- Virtual Fabric ID--Specifies the accessible Virtual Fabrics for a user account.
- Home Virtual Fabric--Specifies the default Virtual Fabric for a user account.
- Role--Determines functional access levels within the Virtual Fabric.

When the Admin Domain capability is enabled, each user-defined account is associated with the following:

- Admin Domain list--Specifies the accessible Admin Domains for a user account.
- Home Admin Domain--Specifies the default Admin Domain for a user account. The home Admin Domain must be a member of the user's Admin Domain list.
- Role--Determines functional access levels within the bounds of the user's current Admin Domain.

NOTE

Virtual Fabrics and Admin Domains are mutually exclusive.

Access rights for any user session are determined by the user's role-based access rights. Refer to [Introducing Web Tools](#) on page 19 for additional information about Role-Based Access Control (RBAC).

The **User** tab of the **Switch Administration** window ([Figure 38](#) on page 199) displays account information. You can create and manage accounts depending on your role. The roles and permissions are listed in the following table.

TABLE 19 User role and permissions

Role	Permissions
admin	Create and manage all predefined and user-defined accounts
operator	Change your own password and cannot create, modify, or view predefined or user-defined accounts
securityadmin	Create and manage all security roles
switchadmin	Change your own password and cannot create, modify, or view predefined or user-defined accounts
zoneadmin	Change your own password and cannot create, modify, or view predefined or user-defined accounts
fabricadmin	Change your own password and cannot create, modify, or view predefined or user-defined accounts
basicswitchadmin	Change your own password and cannot create, modify, or view predefined or user-defined accounts
user	Change your own password and cannot create, modify, or view predefined or user-defined accounts

Virtual Fabrics considerations

If no home logical fabric ID is specified for a user, the system provides a default home ID. The default home ID is 128.

Admin Domain considerations

For legacy users with no Admin Domain specified, the user has access to AD 0 through 255 (physical fabricadmin) if their current role is Admin. Otherwise, the user has access to AD0 only.

If some Admin Domains were defined for the user and all of them are inactive, the user is not allowed to log in to any switch in the fabric.

If no Home Domain is specified for a user, the system provides a default home domain. The default home domain for predefined account is AD0. User-defined accounts, the default home domain is the Admin Domain in the user's Admin Domain list with the lowest ID.

NOTE

The **User** tab displays and changes information in the switch database. If you have RADIUS configured, note that this tab displays the logged-in RADIUS account information but does not allow the user to modify the RADIUS host server database.

FIGURE 38 User tab

The screenshot shows the 'User' tab in the Switch Administration interface. At the top, there is a 'Show Advanced Mode' button. Below it, the switch name 'wt-5100-46' and WWN '10:00:00:05:1e:41:5e:41' are displayed, along with the date and time 'Mon Jan 31 2011 16:34:27 GMT+00:00'. The 'User' tab is selected among other tabs like 'Switch', 'Network', 'Firmware Download', 'License', and 'Trunking'. The main area is titled 'Switch User Account' and contains a table of user accounts. Above the table are buttons for 'Add...', 'Modify...', 'Remove', 'Change Password...', 'Expire Password', 'Unlock Password', and 'Set Password Rule...'. Below the table are 'User' and 'Role' tabs, and 'Apply', 'Close', and 'Refresh' buttons. A status bar at the bottom indicates '[Switch Administration opened]: Mon Jan 31 2011 16:32:27 GMT+00:00' and shows 'Add up to 256 User defined accounts', 'Mode: Basic', 'Free Professional Management Tool', '10.24.51.46', 'User: admin', and 'Role: admin'.

User Name	Role	Description	Status	Expiration Date	Expiration Status	Lockout
root	root	root	Enabled		No	No
factory	factory	Diagnostics	Enabled		No	No
admin	admin	Administrator	Enabled		No	No
user	user	User	Enabled		No	No
qwewq	user	weqwe	Enabled		No	No
fabric	zoneadmin		Disabled		No	No
swadmin	switchadmin	switch admin	Enabled		No	No
fadmin	fabricadmin		Enabled		No	No
zadmin	zoneadmin		Enabled		No	No
bswadmin	basicswitchadmin		Enabled		No	No
secadmin	securityadmin		Enabled		No	No
irul	switchadmin	test	Enabled		No	No

Viewing user account information

To view user account information, perform the following steps.

1. Open the **Switch Administration** window as described in [Opening the Switch Administration window](#) on page 52.
2. Select the **User** tab.

A list of the default and user-defined accounts displays. If you are logged in using the switchadmin role, only your account information displays.

Creating user-defined accounts

To create user-defined accounts, perform the following steps.

1. Open the **Switch Administration** window as described in [Opening the Switch Administration window](#) on page 52.
2. Select the **User** tab.
3. Click **Add**.

The **Add User Account** dialog box displays. For switches that support Virtual Fabrics, refer to the following figure.

FIGURE 39 Add User Account dialog box (VF)

The dialog box is titled "Switch Admin: Add User Account". It contains the following fields and controls:

- User Name: [Text Input]
- Description: [Text Input]
- Status: Enabled Disabled
- New Password: [Text Input]
- Confirm Password: [Text Input]
- Logical Fabric Table:

Logical Fabric ID	User Role
1	No Access
2	No Access
3	No Access
4	No Access
5	No Access
6	No Access
7	No Access
- Home Logical Fabric Id: [Dropdown Menu] (Value: 128)
- Chassis Access Role: [Dropdown Menu] (Value: No Access)
- Buttons: OK, Cancel, Help...

For switches that support Administrative Domains (AD), refer to the following figure.

FIGURE 40 Add User Account dialog box (AD)

4. Enter the user name.

The user name must begin with an alphabetic character. The name can be up to 40 characters long. It is case-sensitive and can contain alphabetic and numeric characters, the period (.) and the underscore (_). It must be different from all other account names on the logical switch.

5. Select a role from the drop-down menu.

For VF-enabled switches, the selection is done per logical fabric ID. (Refer to [Role-Based Access Control](#) on page 32 for information about these roles.)

6. Optional: Enter a description of the account.
7. Click **Enabled** or **Disabled** to enable or disable the account.
8. Enter the password for the account.

The password is not displayed when you enter it on the command line. Passwords can be from 8 through 40 characters long. They must begin with an alphabetic or numeric character. They can include alphanumeric characters, the period (.), and the underscore (_). They are case-sensitive.

Passwords must also meet any additional password rules that were set up. (Refer to the procedure [Setting the rules for passwords](#) on page 204 for more information.)

9. Retype the password in the **Confirm Password** field for confirmation.

10. Check the available Virtual Fabrics or Admin Domains that you can access.

For Virtual Fabrics, all logical fabrics IDs (1-128) are displayed, even if they have not all been created. Only Admin Domains that were created and are accessible to you display.

If all the Admin Domains in the list are inactive, then you cannot log in to the switch.

The **All** option does not mean all of the listed Admin Domains; it means all Admin Domains from AD0 through AD255, regardless of whether they were already created.

The **All** button is disabled unless the following conditions are met:

- The selected role for the target user must be admin or securityadmin.
- You must be a physical fabric administrator.

Selecting **All** makes the target user account a physical fabric administrator.

11. Select a home logical fabric ID if Virtual Fabrics are enabled, or select a home domain for the user from the **Home AD** menu if Admin Domains are enabled.

The default home logical fabric ID is 128.

NOTE

If AD0 is deselected in the user's Admin Domain list and no other Admin Domains are selected, the next available Admin Domain becomes the user's default home Admin Domain.

12. For Virtual Fabrics environments, select a **Chassis Role**.

The chassis role determines the RBAC role and permissions of the user for performing all chassis-level operations in all logical fabrics.

13. Click **OK**.

14. On the **User** tab, click **Apply** to apply your changes.

Deleting user-defined accounts

To delete user-defined accounts, perform the following steps.

1. Open the **Switch Administration** window as described in [Opening the Switch Administration window](#) on page 52.
2. Select the **User** tab.
3. Select the account to remove and click **Remove**.
4. Click **Apply** to save your changes.

You cannot delete the default accounts. An account cannot delete itself. All active command line interface (CLI) sessions for the deleted account are logged out.

Changing user account parameters

You cannot change the user name of the account using this procedure. To change the user name, you must delete the account and create a new account.

Users can select their own accounts in the user account table and change the password. All other buttons are unavailable.

To change the user account parameters, perform the following steps.

1. Open the **Switch Administration** window as described in [Opening the Switch Administration window](#) on page 52.
2. Select the **User** tab.
3. Select the account to modify.

NOTE

You cannot modify the default root and factory accounts, even if you are logged in as root.

4. Click **Modify**.

The **Modify User Account** dialog box displays.

NOTE

If the user account you are modifying does not have a subset of your Admin Domains, a warning message displays to inform you of the permissions conflict.

5. Select a role from the menu.

You can change the role only on user-level accounts. You cannot change the role on the admin or root accounts. You cannot change the role of your own account.

6. Enter a new description.

You can change the description only on user-level accounts. You cannot change the description of the default accounts. You cannot change the description of your own account.

7. Click **Enabled** or **Disabled** to enable or disable the account.

You can enable and disable user- and admin-level accounts, but not your own account. You cannot enable or disable your own account or the factory account. Only the root account can disable itself. If you disable an account, all active CLI sessions for that account are logged out.

8. Check the available Admin Domains that the user can access.

Only Admin Domains that have already been created and are accessible to you display. If all the Admin Domains in the list are inactive then you cannot log in to the switch.

NOTE

The **All** option does not mean all of the listed Admin Domains; it means all Admin Domains from AD0 through AD255, regardless of whether they were already created.

The **All** button is disabled unless the following conditions are met:

- The selected role for the target user must be admin or securityadmin.
- You must be a physical fabric administrator.

Selecting **All** makes the target user account a physical fabric administrator.

9. Select a home domain for the user from the **Home AD** menu.

If AD0 is deselected in the user's Admin Domain list and no other Admin Domains are selected, the next available Admin Domain becomes the user's default home Admin Domain.

10. Click **OK** and click **Apply** to apply your changes.

Maintaining passwords

When a password expires, the next time that user logs in, Web Tools requires the user to provide a new password.

NOTE

You have to own the switch in order to modify password rules.

A password becomes locked if a user has exceeded the maximum number of failed login attempts. This number is specified in the **Lockout Threshold** field. To unlock a locked password, refer to the unlock procedure in [Unlocking a password](#) on page 205.

Changing the password of an account

If you are logged in as admin, you can change the password of your own account, peer admin accounts, switchadmin accounts, and user accounts. You can also change the root or factory account passwords.

If you are changing the password of an admin account, you must also provide the current password. You do not need to provide the current password if you are changing the password of a lower-level user account.

Passwords can be from 8 through 40 characters long. They must begin with an alphabetic or numeric character. They can include alphanumeric characters, the period, and the underscore (_). They are case-sensitive.

Passwords must also meet any additional password rules that were set up. (Refer to [Setting the rules for passwords](#) on page 204 for more information.)

To change the password of an account, perform the following steps.

1. Open the **Switch Administration** window as described in [Opening the Switch Administration window](#) on page 52.
2. Select the **User** tab.
3. Select the account to modify.

If you are logged in as a switchadmin, you can only change the password of your own account.

4. Click **Change Password**.

The **Set User Account Password** dialog box displays.

5. Enter the current password of the account.

This step is required only if you are changing the password of your own or a peer admin account.

6. Enter the new password of the account.

The new password must have at least one character different from the old password.

7. Retype the new password in the **Confirm Password** field.
8. Click **OK**.
9. Click **Apply** to save your changes.

Setting the rules for passwords

To set rules for passwords, perform the following steps.

1. Open the **Switch Administration** window as described in [Opening the Switch Administration window](#) on page 52.
2. Select the **User** tab.
3. Click **Set Password Rule**.

The **Configure Password Rule** dialog box displays.

4. Fill out the dialog box for the password rules you want to enforce.

The available options are:

- Minimum number of days (0-999) before you can change the password again
- Number of days (0-999) before a password expires
- Number of password changes before you can reuse a password
- Minimum password length (8-40 characters)
- Minimum number of uppercase and lowercase characters required
- Minimum number of digits and punctuation characters required
- Number of characters that can be repeated in the password
- Number of failed login attempts (0-999) before the password is locked from further change attempts, and the amount of time the password is locked (0-99999 minutes)
- Number of days to warn user before password expiration (0-999)

5. Select whether to enable or disable the lockout administration features.

If you select to disable the lockout administration, the user is never locked out of the system.

6. Click **OK** to close the dialog box.
7. Click **Apply** to save your changes.

Setting a password as expired

To set a password as expired, perform the following steps.

1. Open the **Switch Administration** window as described in [Opening the Switch Administration window](#) on page 52.
2. Select the **User** tab.
3. Select the account.
4. Click **Expire Password**.

If the button is unavailable, the password is already expired.

5. Click **Apply** to save your changes.

Unlocking a password

To unlock a password, perform the following steps.

1. Open the **Switch Administration** window as described in [Opening the Switch Administration window](#) on page 52.
2. Select the **User** tab.
3. Select the account.
4. Click **Unlock Password**.

If the button is unavailable, the password is already unlocked or was not locked out.

5. Click **Apply** to save your changes.

Displaying roles and assigned logical fabrics

You can display user role assignments for logical fabrics.

1. Open the **Switch Administration** window as described in [Opening the Switch Administration window](#) on page 52.
2. Select the **User** tab.
3. Select an account.
4. Select **Show Role and VF**. The role mapping for that user displays.

User-defined roles

User-defined roles provide the ability to create roles dynamically on the switch. The default roles, such as Root, Factory, Admin, User, SwitchAdmin, ZoneAdmin, FabricAdmin, BasicSwitchAdmin, SecurityAdmin, and Operator, are defined by giving different permissions for different features, or by restricting access to various features. The default roles cannot be edited for assigning different privileges. However, user-defined roles provide the ability to create new roles and define permissions for the RBAC classes.

Guidelines and restrictions

Follow these guidelines and restrictions when creating and configuring user-defined roles:

- In order for the user-defined role to be able to edit the Port Admin and FCR configuration, you must assign the RBAC_SwitchPortManagement and RBAC_SwitchPortConfiguration RBAC classes to the role.
- In order for the user-defined role to be able to set the Fabric ID, you must assign the RBAC_FabricRouting and RBAC_SwitchConfiguration RBAC classes to the role.
- In order for the user-defined role to be able to view reports, you must assign the RBAC_SwitchManagement, RBAC_SwitchConfiguration, and RBAC_FRUManagement RBAC classes to the role.

For some functionality and operations, which needs chassis level access, the user-defined role privileges must be assigned at both the chassis level and the Logical Fabric level to have the corresponding tab enabled:

- In order for the user-defined role to have access to the **System Monitor** which displays **CPU** and **Memory Usage** under the **Monitor** tab, you must assign read/write RBAC_FabricWatch permission and CHASSIS_CONTEXT context type to the Chassis Access Role.
- In order for the user-defined role to have access to the **Configure** tab, you must assign either the RBAC_ConfigManagement, RBAC_SwitchConfiguration, or RBAC_Configure classes to the user-defined role, which is applied at the Logical Fabric level. Any of these three classes are sufficient.
- In order for the user-defined role to have access to the **Security Policy** tab, you must assign either the RBAC_Authentication, RBAC_FabricDistribution, RBAC_Security, RBAC_IPSec, RBAC_AG, or RBAC_IPfilter classes to the user-defined role, which is applied at the Logical Fabric level. Any of these six classes is sufficient.
- In order for the user-defined role to have access to the **Switch** tab, you must assign either the RBAC_SwitchConfiguration, RBAC_SwitchManagement, RBAC_FRUManagement, RBAC_AG, or RBAC_Configure classes to the user-defined role, which is applied at the Logical Fabric level. Any of these five classes is sufficient.

Creating a user-defined role

To add a user-defined role, perform the following steps.

1. Open the **Switch Administration** window as described in [Opening the Switch Administration window](#) on page 52.
2. Select the **User** tab.
3. Select the **Role** subtab.
4. Click the **Add** button.

The **Switch Admin: Add User Defined Role** dialog box displays.

FIGURE 41 Switch Admin: Add User Defined Role dialog box

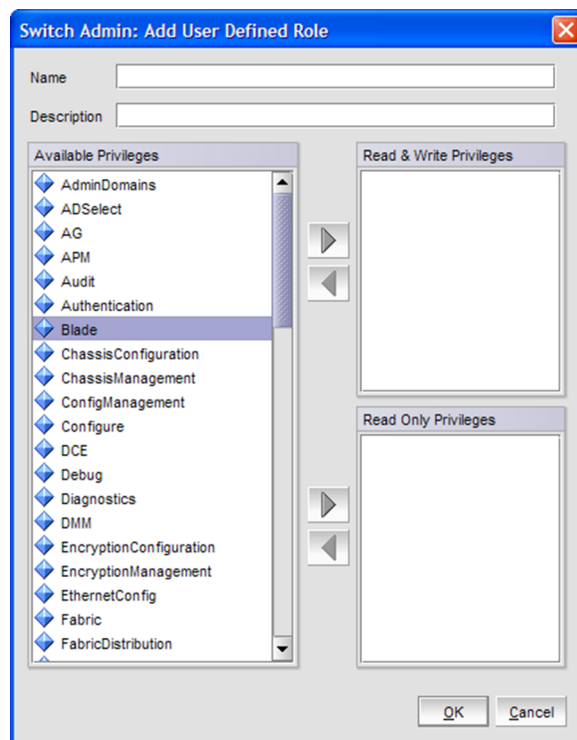

5. Enter a role name in the **Name** field.
6. Enter a description of the role in the **Description** field.
7. To grant the role a read/write privilege, select the privilege and click the right arrow next to the **Read & Write Privileges** section.

You can select multiple privileges.

8. To grant the role a read privilege, select the privilege and click the right arrow next to the **Read Privileges** section.

You can select multiple privileges.

9. To delete a privilege, select it and click the left arrow.
10. Click **OK** to save your changes.

Editing a user-defined role

To edit a user-defined role, perform the following steps.

1. Open the **Switch Administration** window as described in [Opening the Switch Administration window](#) on page 52.
2. Select the **User** tab.
3. Select the **Role** subtab.
4. Select an existing user-defined role.
5. Click the **Edit** button.

The **Switch Admin: Edit User Defined Role** dialog box displays.

FIGURE 42 Switch Admin: Add User Defined Role dialog box

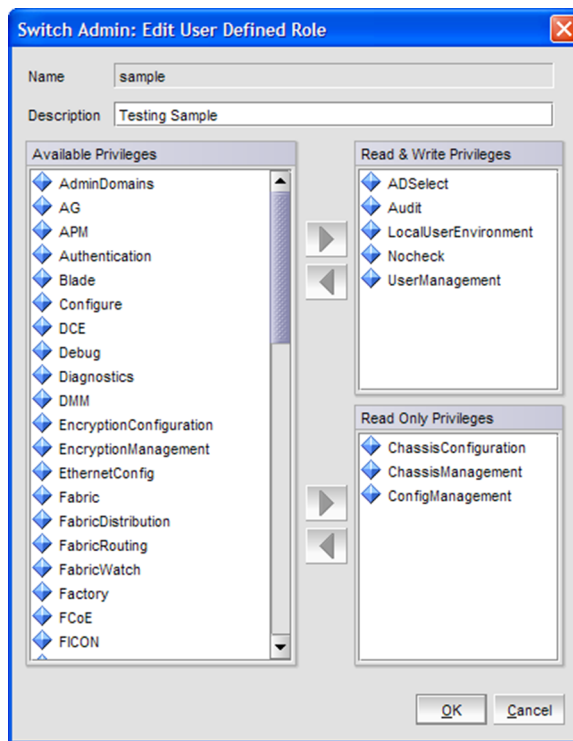

6. To grant the role a read/write privilege, select the privilege and click the right arrow next to the **Read & Write Privileges** section.

You can select multiple privileges.

7. To grant the role a read privilege, select the privilege and click the right arrow next to the **Read Privileges** section.

You can select multiple privileges.

8. To delete a privilege, select it and click the left arrow.
9. Click **OK** to save your changes.

Access control list policy configuration

Support for the Access Control List (ACL) policies is currently defined in the Switch Connection Control (SCC) and Device Connection Control (DCC) policies. SCC and DCC policy configuration in base Fabric OS is performed on a switch-local basis.

Fabric Configuration Server (FCS) Policy can be created only once. While creating the FCS policy, the local switch WWN is automatically included in the list. In the FCS list, the switch in the first position becomes the primary FCS switch. If the first switch in the FCS list is not reachable, the next switch becomes the primary switch. You can also explicitly specify the primary FCS switch.

If there is no SCC, DCC, or FCS policy, the defined and active list is blank.

Virtual Fabrics considerations

ACL policies can be implemented at the logical switch/logical fabric level.

Admin Domain considerations

ACL management can be done on AD255 and in AD0 only if there are no other user-defined Admin Domains. Both AD0 (when no other user-defined Admin Domains exist) and AD255 provide an unfiltered view of the fabric. If there are user defined Admin Domains, then ACL management can be done on AD255 only.

Creating an SCC, DCC, or FCS policy

You can create the FCS policy only once.

To create an SCC, DCC, or FCS policy, perform the following steps.

1. Open the **Switch Administration** window as described in [Opening the Switch Administration window](#) on page 52.
2. Select the **Security Policies** tab.
3. Select the **ACL** subtab.
4. Select a policy by clicking on the appropriate tab (**SCC**, **DCC**, or **FCS**).
5. Click **Edit**.

This launches the **ACL Policy Configuration** wizard.

6. Select the policy type you want to edit.
7. Click **Next** and click **Create**.
8. SCC Option: Add switches to an SCC policy by selecting one or more switches and clicking **Add** or **Add All**.
9. SCC Option: To add an offline switch, click **Add other Switch** and enter the WWN.
10. DCC Option: Select the ports to add to a DCC policy.

When you launch the **DCC Policy Configuration** wizard, only the launched switch and its ports are listed in the tree. All the devices in the fabric are also listed in the tree.

11. In the **ADD Domain, Port Index** field, enter the value in the Domain, Index format and click **Add**.
12. Click **OK** to confirm the changes to the switch.
13. Activate the policy in order to implement it. Refer to [Activating all SCC, DCC, or FCS policies](#) on page 210 for instructions.

Editing an SCC, DCC, or FCS policy

To edit an SCC, DCC, or FCS policy, perform the following steps.

1. Open the **Switch Administration** window as described in [Opening the Switch Administration window](#) on page 52.
2. Make sure the **Show Advanced Mode option** is selected.
3. Select the **Security Policies** tab.
4. Select a policy by clicking on the appropriate tab.
5. Click **Edit**.

This launches the **ACL Policy Configuration** wizard.

6. Select the policy type you want to edit.
7. Click **Next** and click **Modify**.
8. Select a switch or highlight multiple switches to add to the policy by clicking **Add** or **Add All**.
9. Select a switch or highlight multiple switches to remove a policy by clicking **Remove**.
10. Click **Next** and click **Finish** to confirm the changes to the switch.

Deleting all SCC, DCC, or FCS policies

You cannot delete the FCS policy from non-primary or non-FCS switches.

The **Delete All** button is enabled only when there is at least one policy activated.

To delete all SCC, DCC, or FCS policies, perform the following steps.

1. Open the **Switch Administration** window as described in [Opening the Switch Administration window](#) on page 52.
2. Select the **Security Policies** tab.
3. Click **Delete All**.

A warning message displays.

4. Click **OK** to delete all the policies.

Activating all SCC, DCC, or FCS policies

After a policy is created or modified, you can distribute it to the remaining fabric.

To delete a policy, you must activate a new or empty policy.

To activate all SCC, DCC, or FCS policies, perform the following steps.

1. Open the **Switch Administration** window as described in [Opening the Switch Administration window](#) on page 52.
2. Select the **Security Policies** tab.
3. Click **Activate All** to activate all the policies.

NOTE

Activating the policy moves it into the **Activate Policy Set** window.

Distributing an SCC, DCC, or FCS policy

Perform this procedure to distribute an SCC, DCC, or FCS policy.

NOTE

SCC and DCC policy can be distributed only for a primary switch.

To distribute an SCC, DCC, or FCS policy, perform the following steps.

1. Open the **Switch Administration** window as described in [Opening the Switch Administration window](#) on page 52.
2. Select the **Security Policies** tab.
3. Select the appropriate tab (**SCC**, **DCC**, or **FCS**).
4. Click **Distribute Policy**.
5. Select the switches that will receive the policy.
6. Select **OK**.

If the policy distribution fails, an error dialog box displays.

Moving an FCS policy switch position

You can move the position of a primary switch in the FCS policy list.

To move an FCS policy switch position, perform the following steps.

1. Open the **Switch Administration** window as described in [Opening the Switch Administration window](#) on page 52.
2. Click **Show Advanced Mode**.
3. Select the **Security Policies** tab.
4. Select the **FCS** tab.
5. Click **Move FCS Switch**.
6. Select the appropriate from and to positions.
7. Click **Apply**.
8. After you move all the member switches, click **Apply** and **Close**.

Configuring Advanced Device Security policy

The ADS policy allows you to restrict devices that are logged into the fabric using a particular F_Port. When this policy is enabled only authorized devices are allowed to log in the fabric. This can be achieved by allowing all the devices, blocking all the devices, or giving access to selected devices. ADS is supported only in Access Gateway mode.

The restrictions to device login are:

- **All Access** --Allows all the devices to log in to the fabric through that F_Port.
- **No Access** --Blocks all the devices trying to log in to the fabric through that F_Port.
- **WWNs** --Allows only selected WWNs to log in to the fabric through that F_Port. NPIV-capable device port WWNs can also be added to the allowed list of device port WWNs for the particular F_Port.

When the ADS policy is enabled the first time, all the F_Ports are set to **All Access** and all the devices are allowed to log in to the fabric. This configuration persists for subsequent logins from all devices. Existing devices that are already logged in to the fabric are not affected.

When the ADS policy is disabled, all the allowed lists are cleared and all the devices are allowed to log in to the fabric.

To configure ADS policy, perform the following steps.

1. Open the **Switch Administration** window as described in [Opening the Switch Administration window](#) on page 52.
2. Click **Show Advanced Mode**.
3. Select the **Security Policies** tab to configure the ADS policy in Access Gateway mode.
4. Select the **ADS** option.
5. Select the **Enable ADS Policy** option.

The **Configure Advanced Device Security Port WWN** table displays.

6. Optional: Select an F_Port from the table and click the **Edit** button.

The **ADS Port WWN Configuration** dialog box displays. You can configure device port WWNs that can be allowed to log in to a particular F_Port by adding them to the **Selected WWN** list.

7. Select either **All Access**, or a list of selected WWNs.
8. Optional: You can add the detached port WWN to the selected WWNs list by adding the WWN in the **detached WWN** text field and clicking **Add**.
9. Optional: For a selected F_Port, if you select the **Show device WWN connected to this port** check box of the **ADS Port WWN Configuration** dialog box, only connected devices are listed in the **Available WWNs** list. When you clear the check box, all the connected device port WWNs and detached WWNs added to the AG are listed in the **Available WWNs** list.

Fabric-Wide Consistency Policy configuration

Fabric-Wide Consistency Policy (FWCP) configures the Fabric Wide Consistency behavior of distributable ACL policies. The policy ensures that the switches in the fabric enforce the same policies. Set a strict or tolerant fabric-wide consistency policy for each ACL policy type (SCC, DCC, FCS) to automatically distribute that database when a policy change is activated. If a fabric-wide consistency policy is not set, then the policies are managed on a per switch basis.

To set the fabric-wide consistency policy for an SCC, DCC or FCS policy, perform the following steps.

1. Open the **Switch Administration** window as described in [Opening the Switch Administration window](#) on page 52.
2. Select the **Security Policies** tab.
3. Under **Security Policies**, click **FWCP**.
4. Select one of the following consistency behavior for the required policy type (**SCC, DCC, FCS**).
 - Absent
 - Tolerant
 - Strict

NOTE

You can change the consistency behaviors of SCC, DCC, or FCS policy only for a primary switch.

5. Click **Apply**.
6. Click **Yes** to accept the changes.

NOTE

If the switch is not a primary switch, an error message dialog box displays.

7. Click **No** to discard the changes and click **Refresh** in the **FWCP Configuration** window to manually refresh the window.
8. Click **Close**.

Authentication policy configuration

You can configure an authentication protocol policy for E_Port and F_Port authentication, and then distribute the authentication policy to other switches in the fabric. You can also set shared secret keys.

Configuring authentication policies for E_Ports

To configure authentication policies for E_Ports, perform the following steps.

1. Open the **Switch Administration** window as described in [Opening the Switch Administration window](#) on page 52.
2. Select the **Security Policies** tab.
3. Select **Authentication** on the **Security Policies** menu.
4. In the **Authentication Type** field, select **FCAP** or **DHCHAP**.
5. Select the switch authentication policy mode:

On	Strict authentication is enforced on all E_Ports.
Active	The switches can be connected to a switch with any type of policy.
Passive	The switch does not initiate authentication but participates if the connecting switch initiates authentication.
Hash	A hash function (like SHA, SHA 256, or MD5) is used for authentication.
Off	The switch does not support authentication. Any authentication negotiation is rejected.

6. Select a **DH-Group** type.
7. Optional: Set the **device authentication policy mode** to either **off** or **passive** and click **Apply**.

Configuring authentication policies for F_Ports

To configure authentication policies for F_Ports, perform the following steps.

1. Open the **Switch Administration** window and click **Show Advanced Mode** , if not selected.
2. Select the **Security Policies** tab.
3. Select **Authentication** on the **Security Policies** menu.
4. In the **Authentication Type** field, select **DHCHAP**.

NOTE

You must select **DHCHAP** when you are configuring authentication for an F_Port.

5. Set the **switch authentication mode** to either **off** or **passive** and click **Apply**.

Distributing authentication policies

Authentication policies are distributed only if all the selected switches accept the distribution. Only the policy mode is distributed to the selected switches. The switch initiating the distribution must accept distribution.

NOTE

You cannot distribute authentication policies in AD0 unless it is the only Admin Domain.

To distribute authentication policies, perform the following steps.

1. Open the **Switch Administration** window as described in [Opening the Switch Administration window](#) on page 52.
2. Select the **Security Policies** tab.
3. Select **Authentication** on the **Security Policies** menu.
4. Click **Distribute Policy**.
5. Select the switches or click the button to distribute to all.
6. Click **OK**.

Re-authenticating policies

A user who has changed authentication policy parameters or a shared secret key pair can re-initialize the authentication.

To re-authenticate policies, perform the following steps.

1. Click a port in the **Switch View** to open the **Port Admin** tab.
The **Port Admin** tab displays with the port selected.
2. Select **Re-Authenticate** (active only for F_Ports and E_Ports) from the **Actions** list.
3. Close the window.

Setting a shared secret key pair

DH-CHAP requires a shared secret key pair between two entities to authenticate with each other. A key pair consists of a local secret and a peer secret. The local secret identifies the local switch. The peer secret identifies the entity to which the local switch may authenticate.

To set a shared secret key pair, perform the following steps.

1. Open the **Switch Administration** window as described in [Opening the Switch Administration window](#) on page 52.
2. Select the **Security Policies** tab.
3. Select **Authentication** on the **Security Policies** menu.
4. Select the **Shared Secret Keys** subtab.
5. Click **Add**.

The **Add Shared Secret Keys** dialog box displays.

6. Enter the Switch or HBA WWN, name, or domain ID, or use the **Browse** button to select a switch.
7. In the **Peer Secret** and **Confirm Peer Secret** fields, enter the peer secret value.
8. In the **Local Secret** and **Confirm Local Secret** fields, enter the local secret value.
9. Click **Add**.
10. When you are finished adding secret key pairs for switches, click **Apply**.

Modifying a shared secret key pair

You can edit and modify the secret key pairs by switch.

To modify a shared secret pair, perform the following steps.

1. Open the **Switch Administration** window as described in [Opening the Switch Administration window](#) on page 52.
2. Select the **Security Policies** tab.
3. Select **Authentication** on the **Security Policies** menu.
4. Select the **Shared Secret Keys** subtab.
5. Select a secret key pair and click **Edit**.
6. Make the appropriate changes and click **OK**.

Setting the Switch Policy Authentication mode

This setting determines whether or not authentication is required when a switch logs in to a fabric.

To set the Switch Policy Authentication mode, perform the following steps.

1. Open the **Switch Administration** window as described in [Opening the Switch Administration window](#) on page 52.
2. Select the **Security Policies** tab.
3. Select **Authentication** on the **Security Policies** menu.
4. Use the **Switch Policy Authentication Mode** option to select the authentication policy.

SNMP configuration

This section describes how to manage the configuration of the SNMP agent in the switch. The configuration includes SNMPv1 and SNMPv3 configuration, accessControl, and systemGroup configuration parameters.

Access is read-only if you do not have admin or security admin authority.

For more information, refer to the **snmpConfig** command in the *Fabric OS Command Reference*.

Setting SNMP trap levels

To set SNMP trap levels, perform the following steps.

1. Open the **Switch Administration** window as described in [Opening the Switch Administration window](#) on page 52.
2. Select the **SNMP** tab.

3. Select a trap level for a recipient from the corresponding **Trap Level** menu in the **SNMPv1** and **SNMPv3** sections.

The level you select identifies the minimum event level that prompts a trap.

NOTE

Adding or editing the user name can be done only through the CLI and by selecting a user name from the **User Name** menu in the **SNMPv3** section.

4. Click **Apply**.

Changing the systemGroup configuration parameters

To change the systemGroup configuration parameters, perform the following steps.

1. Open the **Switch Administration** window as described in [Opening the Switch Administration window](#) on page 52.
2. Select the **SNMP** tab.
3. Enter a contact name, description, and location in the **SNMP Information** section.
4. Optional: Select the **Enable Authentication Trap** check box to allow authentication traps to be sent to the reception IP address.
5. Click **Apply**.

Setting SNMPv1 configuration parameters

To set SNMPv1 configuration parameters, perform the following steps.

1. Open the **Switch Administration** window as described in [Opening the Switch Administration window](#) on page 52.
2. Select the **SNMP** tab.
3. Double-click a community string in the **SNMPv1** section and enter a new community string.
4. Double-click a recipient IP address in the **SNMPv1** section and enter a new IP address.
5. Click **Apply**.

Setting SNMPv3 configuration parameters

NOTE

The port number is not included.

To set SNMPv3 configuration parameters, perform the following steps.

1. Open the **Switch Administration** window as described in [Opening the Switch Administration window](#) on page 52.
2. Select the **SNMP** tab.
3. Select a user name from the **User Name** menu in the **SNMPv3** section.

NOTE

The list is scrollable. If you do not see your user name, scroll down using the scroll bar or by clicking the **User Name** heading.

4. Double-click a recipient IP address in the **SNMPv3** section and enter a new IP address.
5. Select a trap level from the **Trap Level** menu.
6. Optional: Select the **Enable SNMPv3 Informs for all Trap Recipients** check box to enable or disable inform requests for all trap recipients.
7. Enabling SNMPv3 informs allows you to enter the **Engine ID**.
The Engine ID is required to authenticate the inform request. If informs request is disabled, the SNMP manager does not send a response to the sender.
8. Click **Apply**.

Changing the access control configuration

NOTE

The port number is not included.

To change the access control configuration, perform the following steps.

1. Open the **Switch Administration** window as described in [Opening the Switch Administration window](#) on page 52.
2. Select the **SNMP** tab.
3. Double-click an access host IP address in the **Access Control List** section and enter a new host IP address. You can enter an IP address in either IPv4 or IPv6 format. When you use the IPv6 format, you must include a prefix; for example, `fec0::2002/64`.

NOTE

The list is scrollable. If you do not see your user name, scroll down using the scroll bar or by clicking the **Access Host** heading.

4. Select a permission for the host from the **Access Control List** menu.
Options are **Read Only** and **Read Write**.
5. Click **Apply**.

RADIUS management

Fabric OS supports RADIUS authentication, authorization, and accounting service (AAA). When configured for RADIUS, the switch becomes a Network Access Server (NAS) that acts as a RADIUS client. In this configuration, authentication records are stored in the RADIUS host server database. Login and logout account name, assigned role, and time accounting records are also stored on the RADIUS server.

You should set up RADIUS through a secure connection such as SSH.

The following are the three choices in the drop-down menu when RADIUS is selected as the primary service:

- Switch Database when RADIUS Authentication Fails--When selected, the switch user login database is checked whenever RADIUS authentication fails.
- Switch Database When RADIUS Times Out--Switch user login database is checked only if the physical connection to the RADIUS server fails.
- None--Switch user login database is never checked. Only a RADIUS server can be used for authentication.

If the switch database is selected as primary, there is no secondary option. The RADIUS server cannot be configured as a backup for the switch user login database.

When the primary AAA service is RADIUS, you have three secondary service choices:

- None
- Switch Database when RADIUS authorization fails
- Switch Database when RADIUS times out

When RADIUS login fails, even though RADIUS server is available, the additional service allows you the option to use the Switch Database as backup authentication service when the RADIUS server is not available. Alternatively, you can have no secondary AAA service, which means that only the primary service is used for authentication.

Use the **AAA Service** tab of the **Switch Administration** window to manage RADIUS.

Enabling and disabling RADIUS

At least one RADIUS server must be configured before you can enable RADIUS.

To enable or disable RADIUS, perform the following steps.

1. Open the **Switch Administration** window as described in [Opening the Switch Administration window](#) on page 52.
2. Select the **AAA Service** tab.
3. To enable RADIUS, select **RADIUS** from the **Primary AAA Service** menu.
4. Select **None**, **Switch Database when RADIUS Login Failed**, or **Switch Database when RADIUS Login Timeout** from the **Secondary AAA Service** menu.

NOTE

To disable RADIUS, select **Switch Database** from the **Primary AAA Service** menu and select **None** from the **Secondary AAA Service** menu.

5. Click **Apply**.

Configuring RADIUS

The configuration is chassis-based, so it applies to all logical switches (domains) on the switch and it is replicated on a standby CP, if one is present. It is saved in a configuration upload, and can be applied to other switches in a configuration download. You should configure at least two RADIUS servers so that if one fails, the other server assumes the service.

You can configure RADIUS even if it is disabled. You can configure up to five RADIUS servers. You must be logged in as admin, switchadmin, or securityadmin to configure RADIUS.

To configure RADIUS, perform the following steps.

1. Open the **Switch Administration** window as described in [Opening the Switch Administration window](#) on page 52.
2. Select the **AAA Service** tab.

3. Click **Add**.

The **RADIUS/ADLDAP/TACACS+ Configuration** dialog box displays. You can configure up to five RADIUS servers. If five RADIUS servers are already configured, the **Add** button is disabled.

4. Select **RADIUS** from **Server Type**.
5. Enter the RADIUS server name, as a valid IP address (in either IPv4 or IPv6 format) or Dynamic Name Server string.

Each RADIUS server must have a unique IP address or DNS name for the RADIUS server.

6. Enter the port number.
7. Enter the secret string.
8. Enter the timeout time in minutes.
9. Select either **CHAP** or **PAP** as the authentication protocol.

The default value is CHAP, and if you do not change it, CHAP becomes the authentication protocol.

10. Click **OK** to return to the **AAA Service** tab.
11. Click **Apply**.

Modifying the RADIUS server

To change the parameters of a RADIUS server that is already configured, perform the following steps.

1. Open the **Switch Administration** window as described in [Opening the Switch Administration window](#) on page 52.
2. Select the **AAA Service** tab.
3. Select a RADIUS server from the **RADIUS Configuration** list.
4. Click **Modify**.

The **RADIUS/ADLDAP/TACACS+ Configuration** dialog box displays.

5. Enter new values for the port number, timeout time (in minutes), and secret string.
6. Select either **CHAP** or **PAP** as the authentication protocol.

The default value is CHAP, and if you do not change it, CHAP becomes the authentication protocol.

7. Click **OK** to return to the **AAA Service** tab.
8. Click **Apply**.

Modifying the RADIUS server order

The RADIUS servers are contacted in the order they are listed, starting from the top of the list and moving to the bottom.

To modify the RADIUS server order, perform the following steps.

1. Open the **Switch Administration** window as described in [Opening the Switch Administration window](#) on page 52.
2. Select the **AAA Service** tab.
3. Select a RADIUS server from the RADIUS Configuration list.
4. Click the up and down arrows to rearrange the order of the RADIUS servers.
5. Click **Apply**.

Removing a RADIUS server

To remove a RADIUS server, perform the following steps.

1. Open the **Switch Administration** window as described in [Opening the Switch Administration window](#) on page 52.
2. Select the **AAA Service** tab.
3. Select a RADIUS server from the **RADIUS Configuration** list.
4. Click **Remove**.

If there is no RADIUS server configured, the **Remove** button is disabled. You cannot remove the only RADIUS server if RADIUS is the primary AAA service.

The RADIUS server is not deleted until you apply the changes from the **AAA Services** tab.

5. Click **Apply** in the **AAA Services** tab.

A confirmation displays, warning you that you are about to remove the selected RADIUS server.

6. Click **Yes** in the confirmation.

Active Directory service management

Active Directory is the directory server that holds all the user profiles. Active Directory provides user authentication and authorization using LDAP as authentication protocol. Active Directory provides better security while using remote authentication mechanism.

You can add, remove, and modify settings of Active Directory Server.

Enabling Active Directory service

For adding a new Active Directory server, you must provide the server IP address, port number, secret string, timeout value, and LDAP as the authentication protocol. The server IP address may be in either IPv4 or IPv6 format. Select **Active Directory** as the server type; the dialog box displays LDAP as the only authentication protocol.

To enable Active Directory service, perform the following steps.

1. Open the **Switch Administration** window as described in [Opening the Switch Administration window](#) on page 52.
2. Select the **AAA Service** tab.
3. To enable Active Directory service, select **Active Directory** from the **Primary AAA Service** menu.
4. Select **None**, **Switch Database when Active Directory authentication failed**, or **Switch Database when Active Directory timeout** from the **Secondary AAA Service** menu.

NOTE

To disable **Active Directory** service, select **Switch Database** from the **Primary AAA Service** menu and select **None** from the **Secondary AAA Service** menu.

5. Click **Apply**.

Modifying Active Directory service

To change the parameters of a Active Directory service that is already configured, perform the following steps.

1. Open the **Switch Administration** window as described in [Opening the Switch Administration window](#) on page 52.
2. Select the **AAA Service** tab.
3. Select a server from the **ADLDAP Configuration** list.
4. Click **Modify**.

The **RADIUS/ADLDAP/TACACS+ Configuration** dialog box displays.

5. Enter new values for the port, timeout, and domain.
6. Click **OK** to return to the **AAA Service** tab.
7. Click **Apply**.

Removing Active Directory service

To remove an Active Directory server, perform the following steps.

1. Open the **Switch Administration** window as described in [Opening the Switch Administration window](#) on page 52.
2. Select the **AAA Service** tab.
3. Select a server from the **ADLDAP Configuration** list.
4. Click **Remove**.

NOTE

The server is not deleted until you apply the changes from the **AAA Services** tab.

5. Click **Apply** in the **AAA Services** tab.

A confirmation dialog box displays, warning you that you are about to remove the selected server.

6. Click **Yes** in the confirmation dialog box.

TACACS+ management

TACACS+ provides user authentication and authorization using TACACS as the authentication protocol. You can add, remove, and modify settings of TACACS+ Server.

Enabling and disabling TACACS+

At least one TACACS+ server must be configured before you can enable TACACS+.

To enable or disable TACACS+, perform the following steps.

1. Open the **Switch Administration** window as described in [Opening the Switch Administration window](#) on page 52.
2. Select the **AAA Service** tab.
3. To enable TACACS+, select **TACACS+** from the **Primary AAA Service** menu.

4. Select **None**, **Switch Database when TACACS+ Login Failed**, or **Switch Database when TACACS+ Login Timeout** from the **Secondary AAA Service** menu.

NOTE

To disable TACACS+, select **Switch Database** from the **Primary AAA Service** menu and select **None** from the **Secondary AAA Service** menu.

5. Click **Apply**.

Configuring TACACS+

To enable TACACS+, perform the following steps.

1. Open the **Switch Administration** window as described in [Opening the Switch Administration window](#) on page 52.
2. Select the **AAA Service** tab.
3. Click **Add** to configure TACACS+ service.
4. Select **TACACS+** from **Server Type**.
5. Enter the **Server**, **Port**, **Timeout(s)**, **Secret String** details in the appropriate fields.
6. Select **CHAP** or **PAP** from the **Authentication** list.
7. Click **OK**.

The server details display in the **TACACS+ Configuration** list.

8. Click **Apply**.

Modifying TACACS+

To change the parameters of a TACACS+ service that is already configured, perform the following steps.

1. Open the **Switch Administration** window as described in [Opening the Switch Administration window](#) on page 52.
2. Select the **AAA Service** tab.
3. Select a server from the **TACACS+ Configuration** list.
4. Click **Modify**.

The **RADIUS/ADLDAP/TACACS+ Configuration** dialog box displays.

5. Enter new values for the fields you want to modify.
6. Click **OK** to return to the **AAA Service** tab.
7. Click **Apply**.

Removing TACACS+

To remove a TACACS+ server, perform the following steps.

1. Open the **Switch Administration** window as described in [Opening the Switch Administration window](#) on page 52.
2. Select the **AAA Service** tab.
3. Select a server from the **TACACS+ Configuration** list.
4. Click **Remove**.

NOTE

The server is not deleted until you apply the changes from the **AAA Services** tab.

- Click **Apply** in the **AAA Service** tab.

A confirmation dialog box displays, warning you that you are about to remove the selected server.

- Click **Yes** in the confirmation dialog box.

IPsec concepts

Internet Security Protocol (IPsec) is a set of open standards that provide cryptographic security services for IP networks. Several protocols are available for providing authentication and secure transmission of data.

From Web Tools, you can establish IPsec policies for FCIP implementations on 7800 extension switches with the upgrade license, the 7500 extension switches and FR4-18i blades, and you can establish IPsec policies for IP interfaces that provide management access to switches and control processors.

There are several protocols and algorithms that can be applied. Choosing the protocols and algorithms you want to use may be a matter of adapting to an implementation that is already in place in your LAN, or you may need to do a significant amount of research and planning. The supported protocols and algorithms are defined and described in the RFCs listed in the following table.

TABLE 20 Relevant RFCs

RFC number	Title
RFC 4301	Security Architecture for the Internet Protocol
RFC 4302	IP Authentication Header
RFC 4303	IP Encapsulating Security Payload
RFC 4304	Extended Sequence Number (ESN) Addendum to IPsec Domain of Interpretation (DOI) for Internet Security Association and Key Management Protocol (ISAKMP)
RFC 4305	Cryptographic Algorithm Implementation Requirements for Encapsulating Security Payload (ESP) and Authentication Header
RFC 4869	Suite B Cryptographic Suites for IPsec
RFC 4309	Using Advanced Encryption Standard (AES) CCM Mode with IPsec Encapsulating Security Payload (ESP)
RFC 4306	Internet Key Exchange Version 2 (IKEv2) Protocol
RF C4307	Cryptographic Algorithms for Internet Key Exchange Version 2 (IKEv2)
RFC 3971	Secure Neighbor Discovery
RFC 3972	Cryptographically Generated Addresses
RFC 3041	Privacy Extensions for Stateless Address Auto configuration in IPv6

Transport mode and tunnel mode

Transport mode adds an authentication header (AH) before the IP header. Only a single pair of addresses is used (those in the IP header). When transport mode is used, both endpoints implement IPsec.

Tunnel mode encapsulates an IP datagram in a new datagram, with a new IP header specifying the addresses of the tunnel end points. IPsec is implemented between tunnel endpoints. IPsec is transparent to the actual endpoints within the IP header in the original packet.

The following figure provides a basic visual comparison of how transport mode and tunnel mode modify an IP datagram.

FIGURE 43 Transport mode and tunnel mode comparison

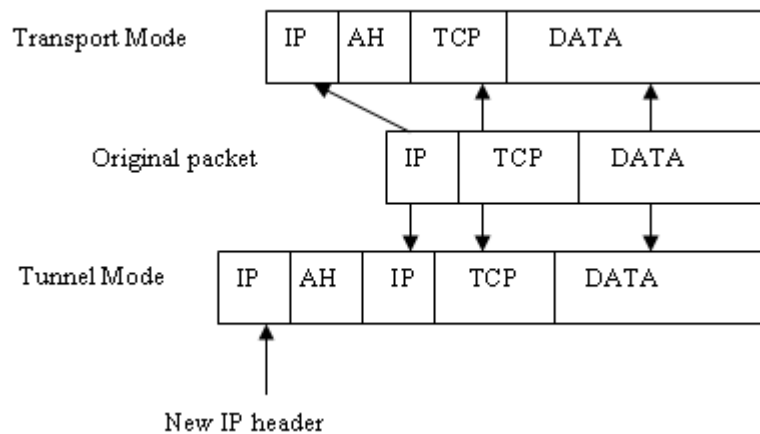

IPsec header options

IPsec adds headers to an IP datagram to enable authentication and privacy. There are two options:

- Authentication Header (AH)
- Encapsulating Security Payload (ESP)

Authentication Header

AH can be used to authenticate a data stream, but does not provide encryption needed for privacy. The AH contains a message authentication code (MAC). The MAC is created by a hash algorithm calculation. The MAC is transmitted in an IP datagram. The same hash algorithm is then used by the receiver to verify the integrity of the packet. AH can be used in either transport mode or tunnel mode, as shown in [Figure 44](#).

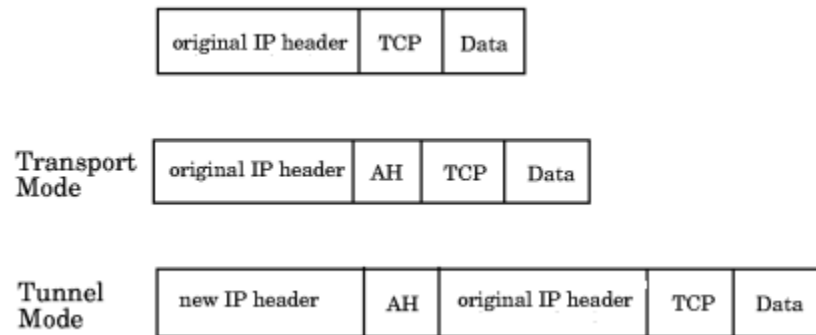
FIGURE 44 AH header in transport mode and tunnel mode

Encapsulating Security Payload

ESP provides authentication, and also provides privacy by encrypting the IP datagram. The use of an ESP header is similar to the use of the AH header. A hash algorithm is used to calculate an authentication value, the authentication value is sent in an IP datagram, and the same hash algorithm is used by the receiver to verify the authentication value. ESP can be used in either transport mode or tunnel mode, as shown in the following figure.

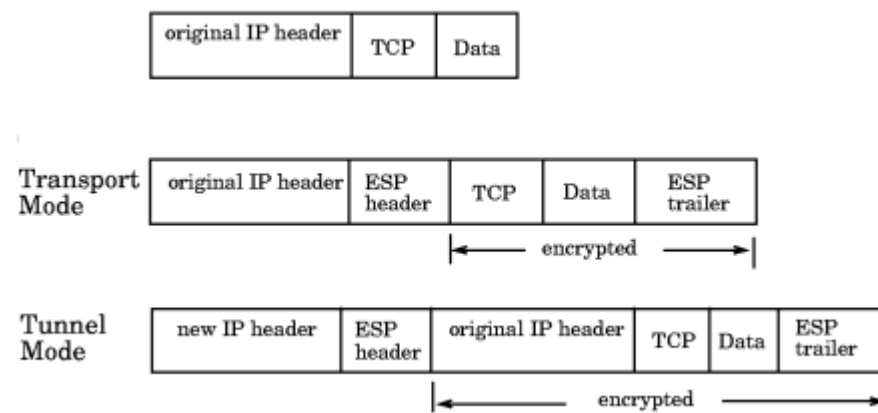
FIGURE 45 ESP header in transport mode and tunnel mode

Basic IPsec configurations

There are three basic configurations for IPsec use:

- Endpoint to Endpoint
- Gateway to Gateway
- Endpoint to Gateway

Endpoint to Endpoint

In an endpoint to endpoint configuration, both endpoints implement IPsec. Transport mode is commonly used in endpoint to endpoint configurations, and only a single pair of addresses is used. Typically, this

kind of configuration would be used for direct communication between hosts. There are two drawbacks to consider:

- If network address translation (NAT) is used on the connection, one or both endpoints may be behind a NAT node. If that is the case, UDP must be used to encapsulate the tunneled packets. Port numbers in the UDP headers can then be used to identify the endpoint behind the NAT node.
- Packets cannot be inspected or modified in transit. This means that QoS, traffic shaping, and firewall applications cannot access the packets, and does not work.

Gateway to Gateway

In a gateway to gateway configuration, IPsec protection is implemented between network nodes. Tunnel mode is commonly used in a gateway to gateway configuration. A tunnel endpoint represents a set of IP addresses associated with actual endpoints that use the tunnel. IPsec is transparent to the actual endpoints.

Endpoint to Gateway

In an endpoint to gateway configuration, a protected endpoint connects through an IPsec protected tunnel. This can be used as a virtual private network (VPN) for connecting a roaming computer, like a service laptop, to a protected network.

Internet Key Exchange concepts

Internet Key Exchange (IKE) is used to authenticate the end points of an IP connection, and to determine security policies for IP traffic over the connection. The initiating node proposes a policy based on the following:

- An encryption algorithm to protect data.
- A hash algorithm to check the integrity of the authentication data.
- A Pseudo-Random Function (PRF) algorithm that can be used with the hash algorithm for additional cryptographic strength.
- An authentication method requiring a digital signature, and optionally a certificate exchange.
- A Diffie-Hellman exchange that generates prime numbers used in establishing a shared secret key.

Encryption algorithms

An encryption algorithm is used to encrypt messages used in the IKE negotiation. The following table lists the available encryption algorithms. A brief description is provided. If you need further information, please refer to the RFC.

TABLE 21 Encryption algorithm options

Encryption algorithm	Description	RFC number
3des_cbc	3DES processes each block three times, using a unique 56-bit key each time.	RFC 2451
null_enc	No encryption is performed.	
aes128_cbc	Advanced Encryption Standard (AES) 128 bit block cipher.	RFC 4869
aes256_cbc	Advanced Encryption Standard (AES) 256 bit block cipher.	RFC 4869

Hash algorithms

Hash message authentication codes (HMAC) check data integrity through a mathematical calculation on a message using a hash algorithm combined with a shared, secret key. The following table lists the available encryption algorithms. The sending computer uses the hash function and shared key to compute a checksum or code for the message, and sends it to the receiving computer. The receiving computer must perform the same hash function on the received message and shared key and compare the result. If the hash values are different, it indicates that a third party may have tampered with the message in transit, and the packet is rejected.

TABLE 22 Hash algorithm options

Hash algorithm	Description	RFC/Publication number
aes_xcbc	Uses a cypher block and extended cypher block chaining (CBC).	RFC 3566
hmac_md5	The MD5 computation produces a 128-bit hash.	RFC 1321
hmac_sha1	The SHA1 computation produces a 160-bit hash.	FIPS Pub 180-1

Pseudo-Random Function algorithm

The Pseudo-Random Function (PRF) algorithm generates output that appears to be random data, using the HMAC chosen as the hash algorithm as the seed value. PRF is used to strengthen security.

Public key certificate-based authentication

Industry standard X.500 database servers are available as certificate authority servers to enable certificate-based authentication of computers.

SA lifetime

The SA lifetime may be defined as the number of bytes transmitted before the SA is rekeyed, or as a time value in seconds, or both. When both are used, the SA lifetime is determined by the threshold that is first reached. Whenever an SA lifetime expires, the security association (SA) is renegotiated and the key is refreshed or regenerated.

For example, if a 200 MB file is transferred with a 100 MB lifetime, at least two keys are generated. If a communication takes one hour, and you specify a lifetime of 300 seconds (five minutes), more than 12 keys may be generated to complete the communication.

The SA lifetime limits the length of time a key is used before it is replaced by a new key, thus limiting the amount of time a given key is available to a potential attacker. Part of a message may be protected by an old key, while new keys protect the remainder of the message, so even if an attacker deciphers one key, only a portion of the message is vulnerable.

Diffie-Hellman groups

Diffie-Hellman (DH) groups are used to determine the length of the base prime numbers for the Diffie-Hellman exchange. Diffie-Hellman key exchange is a cryptographic protocol that allows two parties that have no prior knowledge of each other to jointly establish a shared secret key over an insecure communications channel.

DH group choices are 1(modp768), 2(modp1024), 14(modp2048), and 18(modp8192). Each group provides an incrementally more secure key exchange by providing more bits (768, 1024, 2048, 8192).

Authentication methods

The methods used to authenticate the IKE peer are preshared key (psk), DSS digital signature (dss), and RSA digital signature (rsasig):

- A Preshared key (PSK) is a shared secret that is shared between two parties over a secure channel before it is used. Typically, the PSK is a password or pass phrase. PSKs are created in the end systems used by the two parties. There are several tools available to help select a strong key that will work with various operating systems. When choosing a tool and creating a PSK, keep in mind that the cryptographic strength of a key generally increases with length.
- The Digital Signature Standard (DSS) makes use of a private key to generate a digital signature. Each user possesses a private and public key pair. Signature generation can be performed only by the possessor of the user's private key. The digital signature is sent to the intended verifier in a message. The verifier of the message and signature verifies the signature by using the sender's public key.
- The RSA digital signature process uses a private key to encrypt only the message digest. The encrypted message digest becomes the digital signature and is attached to the original data. To verify the contents of digitally signed data, the recipient generates a new message digest from the data that was received, decrypts the original message digest with the originator's public key, and compares the decrypted digest with the newly generated digest. If the two digests match, the integrity of the message is verified. The identity of the originator also is confirmed because the public key can decrypt only data that has been encrypted with the corresponding private key.

IPsec over management ports

IPsec can be applied to the management port on a switch or a CP blade to establish a secure connection between a PC or workstation and Web Tools. The connection can be used as a virtual private network (VPN) interface to Web Tools.

At a high level, the steps to take are:

- Access the **Ethernet IPsec Policies** dialog box.
- Enable IPsec.
- Create an IKE policy for authentication.
- Create an security association (SA).
- Create an SA proposal.
- Add a IPsec Transform policy, referencing the IKE policy and the SA proposal.
- Add an IPsec selector that allows you to apply a Transform policy to a specific IP flow.

Enabling the Ethernet IPsec policies

To access the **Ethernet IPsec Policies** dialog box, perform the following steps.

1. Open the **Switch Administration** window.
2. Select **Show Advanced Mode**.
3. Select the **Security Policies** tab.
4. Under **Security Policies**, select **Ethernet IPsec**.

The **Ethernet IPsec Policies** dialog box displays.

5. Ethernet IPsec policies can be configured only after enabling IPsec by clicking the **Enable** button below the **Ethernet IPsec policies** table.

Establishing an IKE policy

When you establish an IKE policy, you identify a set of algorithms and authentication rules and parameters to use in a key exchange. Refer to the *Fabric OS Administrator's Guide* for details on IKE functionality.

To establish an IKE policy, perform the following steps.

1. Select the **IKE** tab on the **IPsec Policies** window for Ethernet IPsec.

The **Add IKE Policy** dialog box displays.

2. Enter an **IKE Policy Name**.
3. Enter the IP address of the authentication partner in the **Peer IP Address** field.
4. Enter the switch's local identifier in the **Local Identifier** field.

This is normally the IP address in IPv4 or IPv6 format, but it may also be a DNS name.

5. Enter the identifier of the remote peer switch in **Peer Identifier**.

This is normally the IP address in IPv4 or IPv6 format, but it may also be a DNS name.

6. Select the **Encryption Algorithm** option.
7. Select the **Hash Algorithm** option.
8. Select the **PRF Algorithm** option.
9. Select the **DH Group Number** option.
10. Select the **Authentication Method** option.
11. If PSK is chosen as the authentication method, enter the name of the file that holds the pre-shared key in the **Pre-Shared Key filename** field.
12. If you are using an X.509 certificate for authentication, enter the appropriate file names in the **Public Key filename**, **Private Key filename**, and **Peer Public Key filename** fields in PEM format.
13. Use the **PFS** selector to turn Perfect Forward Secrecy (PFS) on or off.

PFS provides additional security by means of a Diffie-Hellman shared secret value. With PFS, if one key is compromised, previous and subsequent keys are secure because they are not derived from previous keys.

Creating a security association

A security association (SA) describes a set of parameters for providing secure communications between two endpoints.

To create a security association, perform the following steps.

1. Select the **IPsec** tab.

The **IPsec Policies** windows displays.

2. Select the **SA** tab.
3. Select **Add**.

The **Add SA** dialog box displays.

4. Enter a name for the SA in the **SA Name** field.
5. Select the **IPsec Protocol** option.

The choices are ah (for authentication header) and esp (for encapsulated security protocol).

6. Select the **Authentication Algorithm** option.
7. Select the **Encryption Algorithm** option.
8. Optionally, enter a value in the **SPI number** field.

A Security Parameter Index (SPI) number is automatically assigned, but may be manually overridden.

9. Click **OK**.

Creating an SA proposal

An SA proposal is sent from one endpoint to another to negotiate IKE and IPsec policies. An SA proposal contains one or more security associations (SA). The endpoints must find a match for each of the following in the SAs sent in the SA proposal:

- The IKE authentication method.
- The IKE encryption algorithm.
- The IKE hash algorithm.
- The Diffie-Hellman group number.
- The IKE SA lifetime.
- The IP addresses of the endpoints.
- The IPsec protocol (AH or ESP).
- The IPsec Transform policy.

To create an SA proposal, perform the following steps.

1. Select the **SA Proposal** tab on the **IPsec Policies** window.
2. Select **Add**.

The **Add-SA Proposal** dialog box displays.

3. Enter a name in the **SA Proposal Name** field.
4. Enter the SAs in the **SA(s) to use** field.
5. Optionally, define SA lifetime parameters.

The SA lifetime may be defined as a time value in seconds (**LifeTime in seconds**), as the number of bytes transmitted before the SA is rekeyed (**LifeTime in bytes**), or both. When both are used, the SA lifetime is determined by the threshold that is first reached.

6. Click **OK**.

Adding an IPsec transform policy

The IPsec transform policy is the combination of protocols and algorithms applied to a flow of IP packets. IPsec unidirectional, and policies need to be applied to both inbound and outbound flows.

Part of adding an IPsec transform policy is to select an IPsec Protection Type. The choices are discard, bypass, and protect:

- Discard causes data packets to be rejected if there is an invalid pair of source and destination addresses or invalid port addresses.
- Bypass allows a data packet to be transmitted or received without IPsec protection.
- Protect indicates a data packet is processed using IPsec encryption, IKE authentication, or both, using encapsulation security protocol (ESP) processing, or authentication header (AH) protocol processing.

To add an IPsec transform policy, perform the following steps.

1. Select the **Transforms** tab.

The **Transforms** window displays.

2. Select **Add**.

The **Add Transform** dialog box displays.

3. Enter a name in the **Transform Name** field.
4. Select the **IPsec Mode**.

The choices are **Transport** or **Tunnel**.

5. Enter the **SA Proposal** name.
6. Select the **IPsec Protection Type** option.
7. Select the **IKE Policy Name** option.

IKE policies need to be created before adding a transform policy. If there are no names to select from, you must create an IKE policy.

8. Optional: Enter a local and peer IP address.
9. Click **OK**.

Adding an IPsec selector

Selectors are used to apply transform policies to an IP flow. Flows are unidirectional. Selectors are associated with a specific source IP address, a specific peer IP address, and a specific transform.

1. Select the **Selectors** tab.

The **Selectors** window displays.

2. Select **Add**.

The **Add Selector** dialog box displays.

3. Enter a name in the **Selector Name** field.
4. Select the **Traffic Flow Direction** (in or out).

IPsec policies are unidirectional, and must be applied separately to inbound and outbound flows.

5. Enter the IP address of the sender in the **Source IP Address** field.
6. Enter the IP address of the receiver in the **Peer IP Address** field.
7. Enter the **Transform Name** value.
8. The **Protocol Name** selector allows you to select a specific protocol.
9. Click **OK**.

Manually creating an SA

Part of manually creating an security association (SA) is to select an IPsec Protection Type. The choices are discard, bypass, and protect:

- Discard causes data packets to be rejected if there is an invalid pair of source and destination addresses or invalid port addresses.
- Bypass allows a data packet to be transmitted or received without IPsec protection.
- Process indicates a data packet is processed using IPsec encryption, IKE authentication, or both, using encapsulation security protocol (ESP) processing, or authentication header (AH) protocol processing.

To manually create a SA, perform the following steps.

1. Select the **SA(Manual)** tab.
2. Select **Add**.

The **Add Manual-SA** dialog box displays.

3. Enter a security parameter index number in the **SPI (Hexadecimal)** field.

The SPI must be manually applied when manually adding an SA.

4. Enter the IP address of the endpoint that sends the SA in the **Source IP Address** field.
5. Enter the IP address of the endpoint that receives the SA in the **Peer IP Address** field.
6. Select the protocol used to carry the transmission using the **Protocol Name** selector.
7. Select the **Traffic Flow Direction** (in or out).

IPsec policies are unidirectional, and must be applied separately to inbound and outbound flows.

- For the flow from peer to source, select **in**.
- For the flow from source to peer select **out**.

8. Select the **IPsec Mode**.

The choices are **Transport** or **Tunnel**. Refer to [Transport mode and tunnel mode](#) on page 224 if you are unfamiliar with Transport and Tunnel modes.

9. Select the **IPsec Protocol**.

The choices are **ah** (for authentication header) and **esp** (for encapsulated security protocol).

10. Select the **IPsec Protection Type** option.

11. Select the **Authentication Algorithm** option.

12. Enter or copy a generated encryption key in the **Encryption Key** field.

13. Select the **Encryption Algorithm**.

14. Enter or copy a generated authentication key in the **Authentication Key** field.

15. Optional: Enter a local and peer tunnel IP address.

16. Click **OK**.

Editing an IKE or IPsec policy

An existing IKE or IPsec policy can be edited.

To edit an IKE or IPsec policy, perform the following steps.

1. Open the **Switch Administration** window.
2. Click **Show Advanced Mode**.
3. Select the **Security Policies** tab.
4. Under **Security Policies**, select **Ethernet IPsec** or **Ethernet IPsec**.
5. Select the policy you want to edit.
6. Select **Edit**.

An **Edit Policy** dialog box displays.

7. Edit the policy as needed.
8. Click **OK**.

Deleting an IKE or IPsec policy

You can delete one or more IKE or IPsec policies.

To delete an IKE or IPsec policy, perform the following steps.

1. Open the **Switch Administration** window.
2. Select **Show Advanced Mode**.
3. Select the **Security Policies** tab.
4. Under **Security Policies**, select **Ethernet IPsec** or **Ethernet IPsec**.
5. Select the policy or policies you want to delete.
6. Select **Delete**.

The policy is deleted from the SA database (SADB), and is removed from the list.

Establishing authentication policies for HBAs

To establish and enable authentication policies for HBAs as the log in to a fabric, perform the following steps.

1. Open the **Switch Administration** window.
2. Click **Show Advanced Mode**.
3. Select the **Security Policies** tab.
4. Select **Authentication** under Security Policies.

The **Authentication Policy Settings** window displays.

5. Under **Configure Authentication Policy**, do the following.
 - Select the **Authentication Type**. The choices are FCAP, DHCHAP, or both.
 - Select the **Switch Authentication Policy Mode**. The choices are Passive, Active, On, or Off.
 - Select the **Hash Type** used. The choices are SHA1, SHA 256, MD5, SHA 1 and MD5, or all.
 - Select the **DH-Group Type**. The choices are 0, 1, 2, 3, 4; 0 (DH Null option), 1 (1024 bit key), 2 (1280 bit key), 3 (1536 bit key), or 4 (2048 bit key).
 - Use the **Device Authentication Policy Mode** selector to set the desired mode. The choices are On, Off, or Passive.
 - Click **Apply**.
6. If your authentication method uses a shared secret, select the **Shared Secret Keys** tab.

The **Shared Secret Keys** window displays.

7. Select **Add**.

The **Add Shared Secret Keys** dialog box displays.
8. Enter or browse to select the switch/HBA WWN or name or domain ID in the **Switch or HBA WWN/Name/Domain ID** field.
9. Enter the shared secret key for the peer device (an HBA in this case) in the **Peer Shared Secret** and **Confirm Peer Shared Secret** fields.
10. Enter the shared secret for switch in the **Local Shared Secret** and **Confirm Local Shared Secret** fields.
11. Click **Add**.

An entry is added in the **Switch WWN** box.
12. Click **OK**.
13. Add more shared secrets, if needed.

Administering FICON CUP Fabrics

- FICON CUP fabrics overview..... 235
- Enabling port-based routing..... 236
- Enabling or disabling FICON Management Server mode..... 237
- FMS parameter configuration..... 237
- Displaying code page information..... 239
- Viewing the control device state..... 239
- Allow / Prohibit Matrix configuration..... 240
- CUP logical path configuration..... 243
- Link Incident Registered Recipient configuration..... 244
- Displaying Request Node Identification Data 245

FICON CUP fabrics overview

Control Unit Port (CUP) is a protocol for managing FICON directors. Host-based management programs manage the switches using CUP protocol by sending commands to the emulated control device implemented by Fabric OS. A Brocade switch or director that supports CUP can be controlled by one or more host-based management programs or director consoles, such as Brocade Web Tools or Brocade Network Advisor. (Refer to the *Brocade Network Advisor SAN User Manual* for more information about the Brocade Network Advisor.) The director allows control to be shared between host-based management programs and director consoles.

NOTE

To perform FICON CUP operations, the EGM license must be enabled on the switches using the CUP protocol. Also, the EGM license must be enabled to set the Allow/Prohibit Matrix parameters.

The EGM license is required only for 8 Gbps platforms, such as the following:

-
- Brocade Encryption Switch
 - Brocade 300, 5300, 5100 and 5432 switches
 - Brocade VA-40FC
 - Brocade 7800

For non-8 Gbps platforms, all functionalities are available without EGM license.

NOTE

While enabling FMS mode with online devices connected to ports with addresses of 0xFE or 0xFF, the following error message displays: FMS mode enable failed due to port(s) with areas 0xFE or 0xFF is (are) connected to device(s). You must disable the ports or remove the online devices from those ports that are mapped to the 0xFE or 0xFF address.

To use FICON CUP, you must do the following:

- Install a FICON CUP license on a FICON director.
- Enable FICON Management Server (FMS) mode on the FICON director.

- Install a FICON CUP license on the Brocade switch.
- Configure CUP attributes (FMS parameters) for the FICON director.

You can use Web Tools for all of these tasks. You can also use Web Tools to manage FICON directors (when FMS mode is enabled on those directors) to do the following:

- Display the control device state
- Display a code page
- Manage port connectivity configuration

You do not need to install the FICON CUP license to perform FICON CUP management; you *must* install the FICON CUP license, however, if your switch is to enforce traffic between the FICON director and the host-based management program.

NOTE

If the switch does not have the FICON_CUP license installed, Web Tools prevents the enabling of FMS mode, and displays the following error message: Enabling FMS mode requires FICON CUP license installed on the switch. Contact your preferred storage vendor for more details.

Enabling port-based routing

Port-based path selection is a routing policy in which paths are chosen based on ingress port and destination only. This also includes user-configured paths. All ports with FICON devices attached must have port-based routing policy enabled. Port-based routing is a per-switch routing policy. After port-based routing is enabled, you can continue with the remaining FICON implementation.

To enable port-based routing, perform the following steps.

1. Select a switch with FICON devices attached from the **Fabric Tree**.
2. Open the **Switch Administration** window as described in [Opening the Switch Administration window](#) on page 52.
3. Click the **FICON CUP** tab.

If the EGM license is not installed on the switches using CUP protocol, access to this feature is denied and an error message displays. If the EGM license is enabled, the **FICON CUP** tab is available.

4. Click **Enable** in the **FICON Management Server Mode** section to enable the port-based routing policy, or click **Disable** to disable port-based routing.

NOTE

While enabling FMS mode with online devices connected to FE, FF the following error will be shown: FMS mode enable failed due to port(s) with areas 0xFE or 0xFF is (are) connected to device(s).

5. Click **Apply** to save your changes.

Enabling or disabling FICON Management Server mode

FICON Management Server (FMS) is used to support switch management using CUP. To be able to use the CUP functionality, all switches in the fabric must have FICON Management Server mode (FMS mode) enabled. FMS mode is a per-switch setting. After FMS mode is enabled, you can activate a CUP license without restarting the director. You can use Web Tools to install a CUP license. For more information on installing licenses, refer to [Activating a license on a switch](#) on page 67.

When FMS mode is disabled, mainframe management applications, director consoles, or alternate managers cannot communicate with a director with CUP. In addition, when FMS mode is disabled on a director, you cannot configure CUP attributes.

To enable or disable FICON Management Server, perform the following steps.

1. Select a FICON CUP-capable switch from the **Fabric Tree**.
2. Open the **Switch Administration** window as described in [Opening the Switch Administration window](#) on page 52.
3. Click **Show Advanced Mode**.
4. Select the **FICON CUP** tab.

The FICON CUP tabbed page displays the **FICON Management Server** page. All attributes on this tab are disabled until FMS mode is enabled.

5. Click **Enable** in the **FICON Management Server Mode** section to enable FMS mode or click **Disable** to disable FMS mode.
6. Click **Apply** to save your changes.

NOTE

High Integrity Fabric (HIF) must be enabled to enable the FMS mode.

FMS parameter configuration

FMS parameters control the behavior of the switch with respect to CUP itself, as well as the behavior of other management interfaces (director console, Alternate Managers). You can configure FMS parameters for a switch only after FMS mode is enabled on the switch. All FMS parameter settings are persistent across switch power cycles. There are six FMS parameters, as described in the following figure.

TABLE 23 FMS mode parameter descriptions

Parameter	Description
Programmed Offline State Control	Controls whether host programming is allowed to set the switch offline. The parameter is set as enabled by the hardware after system installation, and can be reset by Web Tools.

TABLE 23 FMS mode parameter descriptions (Continued)

Parameter	Description
Active=Saved Mode	<p>Controls the IPL file update. The IPL file saves port connectivity attributes and port names. After a switch restart or power cycle, the switch reads the IPL file and activates its contents as default configuration.</p> <p>When this mode is enabled, activating a configuration saves a copy to the IPL configuration file. All changes made to the active connectivity attributes or port names by host programming or alternate managers are saved in this IPL file. It keeps the current active configuration persistent across switch restarts and power cycles.</p> <p>You cannot directly modify the IPL file or save a file as an IPL file. When this mode is disabled, the IPL file is not altered for either new configuration activation or any changes made on the current active configuration. This parameter is set as enabled by the hardware after system installation, and can be reset by Web Tools.</p> <p>Note: When FMS mode is enabled and the Active=Saved parameter is disabled, you can enable and disable ports, but the setting is not persistent. When the Active=Saved parameter is enabled, you can enable and disable ports and the setting <i>is</i> persistent.</p>
Alternate Control Prohibited	<p>Determines whether alternate managers are allowed to modify port connectivity.</p> <p>Enabling this mode prohibits alternate manager control of port connectivity; otherwise, alternate managers can manage port connectivity.</p> <p>This parameter is set as enabled by the hardware after system installation, and can be reset by Web Tools.</p>
User Alert Mode	<p>Controls director console behavior for alerts.</p> <p>Enabling this mode prompts the director consoles to display a warning whenever you attempt an action that changes switch parameters. When you disable this mode, no warning is displayed. In this case, in which Web Tools is the director console, warning messages are displayed by Web Tools regardless of the setting of the parameter, since Web Tools always displays warning messages when you apply a change to a switch that changes parameters.</p> <p>This parameter is always read-only in Web Tools. Each time that the switch is powered on, the parameter is reset to disabled.</p>
Director Clock Alert Mode	<p>Controls behavior for attempts to set the switch timestamp clock through the director console.</p> <p>When it is enabled, the director console (Web Tools, in this case) displays warning indications when the switch timestamp is changed by a user application. When it is disabled, you can activate a function to automatically set the timestamp clock. There is no indication for timestamp clock setting.</p> <p>This parameter is set as disabled by the hardware after system installation, and can be reset by Web Tools.</p>
Host Control Prohibited	<p>Determines whether host programming allows modifying port connectivity.</p> <p>Enabling this mode prohibits host programming control of port connectivity; otherwise, host programming can manage port connectivity.</p> <p>This parameter is set as disabled by the hardware after system installation. and can be reset by Web Tools.</p>

Configuring FMS mode parameters

To configure FMS mode parameters, perform the following steps.

1. Select a FICON-enabled switch from the **Fabric Tree**.
2. Open the **Switch Administration** window as described in [Opening the Switch Administration window](#) on page 52.
3. Select the **FICON CUP** tab.

The **FICON CUP** page displays the **FICON Management Server** page. All attributes on this page are read-only until FMS mode is enabled.

4. To enable or disable an FMS mode parameter, click the check box next to the parameter.

A checked check box indicates that the parameter is enabled. You cannot configure the **User Alert Mode** parameter in Web Tools, as it is read-only.

Displaying code page information

The **Code Page** section identifies the language used to exchange information between the FICON director and Host Programming. It is a read-only field in Web Tools, as it is set by Host Programming only. When FMS mode is disabled, the code page is displayed as unavailable.

To display code page information, perform the following steps.

1. Select a FICON-enabled switch from the **Fabric Tree**.
2. Open the **Switch Administration** window as described in [Opening the Switch Administration window](#) on page 52
3. Select the **FICON CUP** tab.

The **FICON CUP** page displays the **FICON Management Server** page in front. All attributes on this tab are read-only until FMS mode is enabled.

The code page format is displayed in the **Code Page** section as shown in the following example:

```
Language used to exchange information with Host Programming: (EBCDIC) USA/Canada
-- 00037
```

Viewing the control device state

The control device is in either a neutral or a switched state. When it is neutral, the control device accepts commands from any channel that has established a logic path with it and accepts commands from alternate managers. When the control device is switched, it establishes a logical path and accepts commands only from that logical path ("device allegiance"). Commands from other paths cause a FICON CUP Busy Error. Most "write" operations from alternate managers are also rejected.

Device allegiance usually lasts for a very short time. However, under abnormal conditions, device allegiance can get "stuck" and fail to terminate. It might cause the switch to be unmanageable with CUP, and you will continue to receive the FICON CUP Busy Error. In this case, you should check the control device state and the last update time to identify if the device allegiance is stuck. The Web Tools **Switch Administration** window displays the control device state and last update time. You can click **Refresh** to get most recent update.

NOTE

You can manually reset allegiance to bring the control device back to the neutral state by clicking **Reset Allegiance** in the **FICON CUP Busy Error** dialog box.

The following switch parameters being read or modified can cause the FICON CUP Busy error:

- Mode Register
- Port Names (also called Port Address Name)
- Allow/Prohibit Matrix and Port Connectivity Attributes
- Switch enable/disable
- Switch name change

To access the FICON CUP tab, perform the following steps.

1. Select a FICON-enabled switch from the **Fabric Tree**.
2. Open the **Switch Administration** window as described in [Opening the Switch Administration window](#) on page 52.
3. Select the **FICON CUP** tab.

The FICON CUP tabbed page displays, with the FICON Management Server subtabbed page in front. All attributes on this tab are read-only until FMS Mode is enabled.

The control device state is displayed as neutral or switched in the Control Device Allegiance field.

NOTE

If FMS mode is enabled, and the control device state is unavailable, the FICON CUP Busy Error is displayed. Click **Reset Allegiance** in the error message to reset the control device state to its correct state.

Allow / Prohibit Matrix configuration

In the Allow / Prohibit Matrix subpanel, you can manage the configuration files and active configuration. All configuration files and the active configuration are listed in a table. The active configuration is listed as "Active Configuration*" and the description in the table is "Current active configuration on switch." The other special configuration file is the IPL. Any other files displayed are user-defined configurations and are stored on the switch.

You can create, activate, copy, or delete saved Allow / Prohibit Matrix configurations; however, you can only edit or copy a configuration while it is active. You can also activate, edit, or copy the IPL configuration. You must have FMS mode enabled before you can make any changes to the configurations. Click **Refresh** to get the latest configuration file list from the switch.

When creating a new configuration or editing an existing configuration, the Web Tools port name is restricted to printable ASCII characters. Characters beyond printable ASCII characters are displayed as dots.

When initially installed, a switch allows any port to dynamically communicate with any other port. Two connectivity attributes are defined to restrict this any-to-any capability for external ports: Block and Prohibit.

Block is a port connectivity attribute that prevents all communication through a port. Prohibit is the port connectivity attribute that prohibits or allows dynamic communication between ports when a port is not blocked. Each port has a vector specifying its Prohibit attribute with respect to each of the other ports in the switch. This attribute is always set symmetrically in that a pair of ports is either prohibited or allowed to communicate dynamically.

The Port Connectivity table (shown in [Figure 47](#) on page 242) displays the Port number (in physical-location format), Port Name (port address name), Block attribute, Prohibit attribute, and Area Id (port address, displayed in hexadecimal) in fixed columns. The right side is a port matrix, that lists all ports by Area ID and identifies prohibited ports. Those columns are scrollable and swappable.

Viewing Allow / Prohibit Matrix configurations

To display a list of Allow / Prohibit Matrix configurations, perform the following steps.

1. Select a FICON-enabled switch from the **Fabric Tree**.
2. Select **Configure > Switch Admin**.
3. Click **Show Advanced Mode** to see all the available tabs and options.
4. Select the **FICON CUP** tab.

The **FICON CUP** page displays the **FICON Management Server** page in front. All attributes on this page are read-only until FMS mode is enabled.

5. Click the **Allow / Prohibit Matrix** subtab.

Modifying Allow / Prohibit Matrix configurations

In the **Allow / Prohibit Matrix Configuration** dialog box, swapped ports are indicated with the "(Swapped)" label.

FIGURE 46 Edit Allow / Prohibit Matrix dialog box swapped label

Port#	Port Index
0(0x0)	0(0x0)
1(0x1)	4(0x4) (Swapped)
2(0x2)	3(0x3) (Swapped)
3(0x3)	2(0x2) (Swapped)
4(0x4)	1(0x1) (Swapped)
5(0x5)	7(0x7) (Swapped)
6(0x6)	6(0x6)

To create a new Allow / Prohibit Matrix configuration or to edit an existing configuration, perform the following steps.

1. Display the Allow / Prohibit Matrix configuration list.
2. You can either create a new configuration or edit an existing configuration:

- To create a new configuration, click **New**.

The **Allow / Prohibit Matrix Configuration** dialog box displays all ports and port names on the selected switch (similar to the dialog box shown in the following figure). The **Block** column, **Prohibit** column, and prohibited ports matrix are displayed as empty, for you to configure.

- To edit an existing configuration, click the configuration, and then click **Edit**.

The **Allow / Prohibit Matrix Configuration** dialog box displays the content of the selected configuration from the switch in a table format (as shown in the following figure).

3. Optional: Select the check box corresponding to a port you want to block on the **Block** column. Repeat this step for all ports you want to block. Select the **Block All** check box to block all ports.
4. Optional: Select the check box corresponding to a port you want to prohibit on the **Prohibit** column. Repeat this step for all ports you want to prohibit. Select the **Prohibit All** check box to prohibit all ports.

The cells in the matrix are updated with crossed-circle icons to identify prohibited ports.

FE and FF ports are not shown in the Allow / Prohibit Matrix dialog box. The FE and FF Ports state displays only in the Port Admin page.

5. Optional: Click the individual cells corresponding to the combination of ports you want to prohibit. You cannot prohibit a port to itself.

If you prohibit E_Port, E-E connection, or E-F connection, a warning message is displayed, "You have placed a prohibit on an E-Port. This has no effect for Fabric OS-based fabrics".

6. Review your changes. A blue background in a cell indicates that its value has been modified.
7. After you have finished making changes, do any of the following:
 - Click **Activate** to save the changes and make the configuration active immediately, as described in [Activating an Allow / Prohibit Matrix configuration](#) on page 242.
 - Click **Save** to save the changes but not make the configuration active.
 - Click **Save As** to save the configuration to a new configuration file. When you click **Save As**, a dialog box displays in which you should enter a file name and description for the configuration file.
 - Click **Refresh** to refresh the information from the switch.
 - Click **Cancel** to cancel all changes without saving.

FIGURE 47 Allow / Prohibit Matrix Configuration dialog box

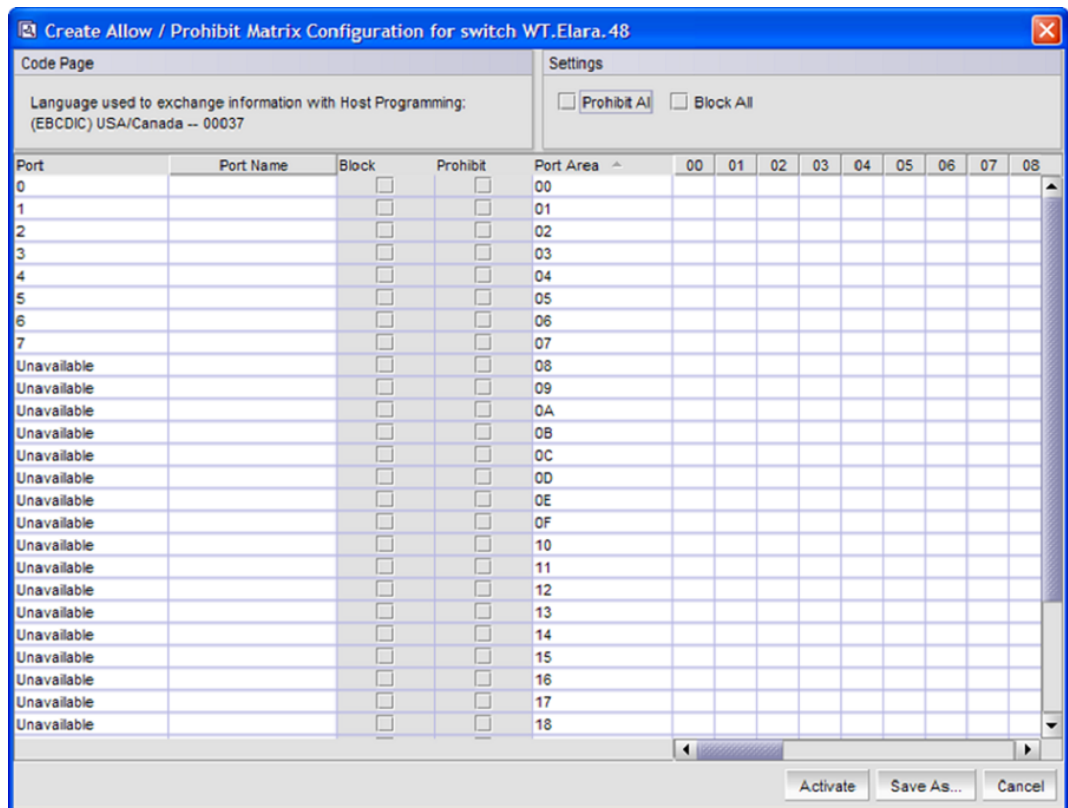

Activating an Allow / Prohibit Matrix configuration

When you activate a saved Allow / Prohibit Matrix configuration on the switch, the preceding configuration (currently activated) is overwritten.

To activate an Allow / Prohibit Matrix configuration, perform the following steps.

1. Open the Allow / Prohibit Matrix configuration list.
2. Select the saved configuration from the list.
3. Click **Activate** .

The **Activate Allow / Prohibit Matrix Configuration** confirmation dialog box displays. The message reminds you that the current configuration will be overwritten upon activation.

4. *Optional* : Click **Active=Saved Mode** to enable (selected) or disable (not selected) the **Active=Saved FMS** parameter after the configuration is activated.
5. Click **Yes** to activate the configuration or click **No** to cancel the activation.

Copying an Allow / Prohibit Matrix configuration

To copy an Allow / Prohibit Matrix configuration to a new configuration, perform the following steps.

1. Display the Allow / Prohibit Matrix configuration list.
2. Select a saved configuration or the active configuration from the list.
3. Click **Copy**.

The **Allow / Prohibit Matrix Configuration** dialog box displays.

4. In the dialog box, enter a name and description for the new configuration and click **OK** to save the configuration to the target file; click **Cancel** to cancel copying the configuration.

The file name must be in alphanumeric characters and can contain only dashes or underscores as special characters.

Deleting an Allow / Prohibit Matrix configuration

To delete a saved Allow / Prohibit Matrix configuration.

1. Display the Allow / Prohibit Matrix configuration list.
2. Select the saved configuration from the list.
3. Click **Delete**.

The **Delete Allow / Prohibit Matrix Configuration** confirmation dialog box displays.

4. Click **Yes** to delete the selected configuration; click **No** to cancel the deletion.

CUP logical path configuration

The logical reporting path is a CUP mechanism for sending FRU-failure type reports to a FICON Logical Path via the FICON Protocol.

Viewing CUP logical path configurations

To display a list of CUP logical path configurations, perform the following steps.

1. Select a FICON-enabled switch from the **Fabric Tree**.
2. Select **Configure > Switch Admin**.
3. Click **Show Advanced Mode** to see all the available tabs and options.
4. Select the **FICON CUP** tab.

The **FICON CUP** page displays the **FICON Management Server** page in front. All attributes on this page are read-only until FMS mode is enabled.

5. Click the **CUP Logical Paths** subtab.

Configuring CUP logical paths

To configure a CUP logical path, perform the following steps.

1. Select a FICON-enabled switch from the **Fabric Tree**.
2. Select **Configure** > **Switch Admin**.
3. Click **Show Advanced Mode** to see all the available tabs and options.
4. Select the **FICON CUP** tab.

The **FICON CUP** page displays the **FICON Management Server** page in front. All attributes on this page are read-only until FMS mode is enabled.

5. Click the **CUP Logical paths** subtab.
6. Select a logical path and click **Set Current**.

Link Incident Registered Recipient configuration

The Link Incident Registered Recipient (LIRR) receives Link Incident Reports (RLIR) on the source N_Port. The LIRR database is stored on the switch.

Viewing Link Incident Registered Recipient configurations

To display a list of Link Incident Registered Recipient (LIRR) configurations.

1. Select a FICON-enabled switch from the **Fabric Tree**.
2. Select **Configure** > **Switch Admin**.
3. Click **Show Advanced Mode** to see all the available tabs and options.
4. Select the **FICON CUP** tab.

The **FICON CUP** page displays the **FICON Management Server** page in front. All attributes on this page are read-only until FMS mode is enabled.

5. Click the **Link Incident Registered Recipient** subtab.

Configuring LIRRs

To configure the Link Incident Registered Recipients (LIRR), perform the following steps.

1. Select a FICON-enabled switch from the **Fabric Tree**.
2. Select **Configure** > **Switch Admin**.
3. Click **Show Advanced Mode** to see all the available tabs and options.
4. Select the **FICON CUP** tab.

The **FICON CUP** page displays the **FICON Management Server** page in front. All attributes on this page are read-only until FMS mode is enabled.

5. Click the **Link Incident Registered Recipient** subtab.
6. Select a port from the list.
7. Click **Set Current**.
8. Click **Close**.
9. Optional: The selected port can be reset using the reset button.

Displaying Request Node Identification Data

Web Tools displays Request Node Identification Data (RNID) information for the local switch, and for attached FICON devices and FICON channel paths. RNID information for the switch displays in the **Switch Information** tab as shown in the following figure.

FIGURE 48 Switch RNID information

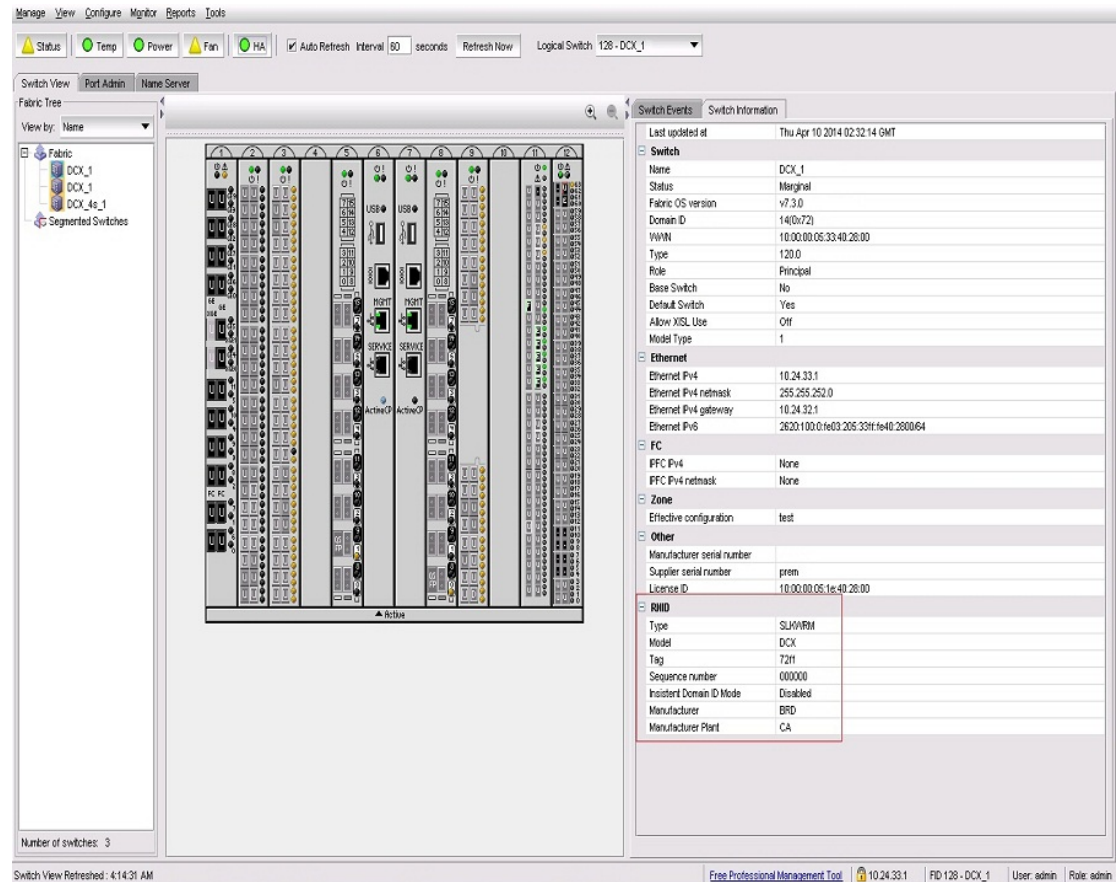

RNID information for attached FICON devices and channel paths displays on the **Name Server** view. To view this information, Click **Name Server** tab to display the **Name Server** view. Ports that completed an RNID exchange display **FICON** in the **Capability** column. For those ports, the following information specific to RNID displays in the following columns:

- Type
- Model
- Tag
- Sequence Number
- Insistent Domain ID Mode
- Manufacturer
- Manufacturer Plant

Configuring FCoE with Web Tools

- [Web Tools and FCoE overview](#)..... 247
- [Web Tools, the EGM license, and Brocade Network Advisor](#)..... 247
- [Switch administration and FCoE](#)..... 248
- [FCoE configuration tasks](#)..... 249
- [Quality of Service configuration](#)..... 249
- [LLDP-DCBX configuration](#)..... 250
- [Configuring DCB interfaces](#)..... 253
- [Configuring a link aggregation group](#) 254
- [Configuring VLANs](#)..... 254
- [Configuring FCoE login groups](#)..... 255
- [Displaying FCoE port information](#)..... 256
- [Displaying LAG information](#)..... 257
- [Displaying VLAN information](#)..... 257
- [Displaying FCoE login groups](#)..... 257
- [Displaying QoS information](#)..... 257
- [Displaying LLDP-DCBX information](#)..... 257
- [Displaying DCB interface statistics](#)..... 258
- [Configuring a DCB interface from the Switch View](#)..... 258
- [Configuring a DCB interface from the Port Admin panel](#)..... 258
- [Enabling and disabling a LAG](#)..... 259
- [Enabling and disabling LLDP](#)..... 259
- [Enabling and disabling QoS priority-based flow control](#)..... 259
- [Enabling and disabling FCoE ports](#)..... 260

Web Tools and FCoE overview

Brocade Web Tools is an embedded graphical user interface (GUI) that enables administrators to monitor and manage single or small fabrics, switches, and ports. Web Tools is launched directly from a web browser, or from Brocade Network Advisor.

A limited set of features is accessible using Web Tools without a license, and is available free of charge. Additional switch management features are accessible using Web Tools with the Enhanced Group Management (EGM) license. Refer to [Web Tools, the EGM license, and Brocade Network Advisor](#) on page 247 for more information.

Web Tools, the EGM license, and Brocade Network Advisor

Beginning with Fabric OS version 6.1.1, Web Tools functionality is tiered and integrated with Brocade Network Advisor. If you are migrating from a Web Tools release prior to Fabric OS version 6.1.1, this may impact how you use Web Tools.

A Web Tools license is not required, and a basic version of Web Tools is available for free. Additional functionality may be added by obtaining the Enhanced Group Management (EGM) license.

The EGM license is required only for 8 Gbps platforms, such as the:

- Brocade Encryption Switch
- Brocade 300, 5300, and 5100 switches
- Brocade VA-40FC
- Brocade 7800

For non-8 Gbps platforms, all functionalities are available without the EGM license.

Port information that is unique to FCoE

The **General** tab in the **Port Admin** tab displays several parameters that are unique to DCB/DCE interfaces:

- **Interface Mode** --The interface mode values are either **None** or **L2** mode.
- **VLAN ID** --The VLANs that carry traffic on the links are attached to this port.
- **LAG** --The ID of the Link Aggregation Group (LAG), with which this port is associated. If no ID is specified, the port is not associated with any LAG.
- **L2 Mode** --The values are **Access**, **Trunk**, or **Converged**. **Access** mode allows only one VLAN association, and allows only untagged frames. **Trunk** mode allows more than one VLAN association, and allows tagged frames. **Converged** mode interface can be native (untagged or access) in one VLAN and it could be non-native (trunk or tagged) type in more than one VLAN.
- **DCB Map** --The name of a DCB map that was created and associated with the port.
- **Traffic Class Map** --The name of a traffic class map that was created and associated with the port.
- **LLDP Status** --Indicates whether LLDP is active or inactive.
- **LLDP Profile** --The name of an LLDP profile that was created and associated with the port.
- **FCoE Priority Bits** --Each bit represents a user priority that is associated with FCoE traffic.
- **Default CoS** --The default Class of Service.

Switch administration and FCoE

The **DCB** tab on the **Switch Administration** window is specific to DCE and DCB configuration and management. The DCB tab has five subtabs that are used for FCoE switch administration:

- **Link Aggregation**
- **VLAN**
- **FCoE Login Group**
- **QoS**
- **LLDP-DCBX**

FIGURE 49 Switch Administration DCB subtabs



FCoE configuration tasks

There are several tasks related to FCoE configuration. The following list describes the high level tasks in a suggested order:

- Quality of Service (QoS) configuration (optional)--If you intend to implement a specific QoS scheme to prioritize data traffic, it is recommended that you finish your QoS configuration before you begin port configuration. QoS values are referenced when you configure ports.
- LLDP-DCBX configuration (optional)--If you intend to implement DCBX, it is recommended that you finish LLDP-DCBX configuration before you configure ports. LLDP-DCBX values are referenced when you configure ports.
- DCB interface configuration (mandatory).
- Link Aggregation Group (LAG) configuration (mandatory)--Ports must be configured before they can be placed into a LAG. The parameters applied to the LAG reflects on each port that is member of the LAG.
- VLAN configuration (optional)--Port and LAG names are referenced in VLAN configuration, and must be defined before you can successfully complete a VLAN configuration.
- Login group configuration (optional)--Login group configuration is not dependent on any of the previous configurations. It can be done as a separate task.

Quality of Service configuration

As a general concept, Quality of Service (QoS) is a mechanism for classifying and scheduling data traffic based on priority settings. QoS can be used to control traffic congestion, allocate bandwidth, and carry data traffic with different characteristics over a common interface.

The following two configuration options are available:

- You can edit the DCB map. The DCB map defines priority and priority group tables that support Enhanced Transmission Selection (ETS). ETS allows allocation of bandwidth to different traffic classes. DCB maps also allow you to enable Priority Flow Control (PFC).
- You can create a traffic class map. A traffic class map can be used to map a specific class of traffic to a specific Class of Service (CoS).

Editing the DCB map

The DCB map defines priority and priority group tables that support Enhanced Transmission Selection (ETS). ETS allows bandwidth to be allocated based on priority settings through an exchange of priority group tables.

To edit the DCB map, perform the following steps.

1. Select the **DCB** tab on the **Switch Administration** window.
2. Select the **QoS** tab.
3. Select the **DCB Map** tab.
4. Select the default DCB map, and click **Edit**.

The **DCB Map Configuration** dialog box displays.

5. Enter a precedence value in the **Precedence** field.

The value is specified as a number. The allowable range is 1 to 100. The default is 1.

The precedence value controls QoS scheduling policies. The scheduler gives precedence to the highest precedence value.

When the **DCB Map Configuration** dialog box displays, the default values shown in the **Priority Group Map** match the IEEE 802.1Q recommendation for systems supporting eight traffic classes. The **Priority Group Map** displays the Layer 2 **CoS** values mapped to **Priority Group ID (PGID)**. PGID values are in the form <policy>.<priority>. A policy value of 15 indicates Priority values run from 0 (highest priority) to 7 (lowest priority). Note that this is contrary to the CoS values, which run from 7 (highest priority) to 0 (lowest priority).

6. Create a new priority group by clicking **Add** next to the **Priority Group** table.

An entry is added to the **Priority Group** table.

NOTE

When you add an entry, a PGID is automatically assigned. The PGID is an integer from 0 to 7. The first added entry is given a PGID of 0, and the PGID increments by one for each additional added entry until a PGID of 7 is reached.

7. Edit the **Bandwidth** entry to indicate the desired percentage of total bandwidth.
8. Change the **Priority Flow Control Status** to **Enabled** to enable PFC for the entry.
9. Click **OK**.

The new priority group displays in the **Priority Group Map**.

Adding a traffic class map

CoS priorities can be mapped to traffic classes using a traffic class map.

1. Select the **DCB** tab on the **Switch Administration** window.
2. Select the **QoS** tab.
3. Select the **Traffic Class Map** tab.
4. Select **Add**.

The **Traffic Class Map Configuration** dialog box displays.

NOTE

This dialog box has the same structure as the **Priority Group Map** in the **DCB Configuration** dialog box. The default CoS-to-traffic class structure is based on IEEE 802.1Q recommendations, as in the default Priority Group Map.

5. Enter a name for the traffic class map in the **Name** field.
6. Select the **Traffic Class** that you want to assign to the **CoS** priority.
7. Click **OK**.

LLDP-DCBX configuration

Link Layer Discovery Protocol (LLDP) is a IEEE standard for collecting and distributing device information. Data Center Bridging Exchange (DCBX) extends LLDP by providing a protocol for discovering, initializing, and managing DCB-compliant devices.

There are two configuration procedures:

- Configuring global LLDP characteristics.
- Configuring an LLDP profile.

Configuring global LLDP characteristics

Configuring at the global level enables you to apply changes to every port.

To configure the global LLDP characteristics, perform the following steps.

1. Select the **DCB** tab on the **Switch Administration** window.
2. Select the **LLDP-DCBX** tab.
3. Select the **Global** tab.
4. Select the **LLDP** check box to enable LLDP globally.

You can clear the check box to disable LLDP.

5. Enter a name for the configuration in the **System Name** field.
6. Optionally, add a description in the **System Description** field.
7. Select the **Mode**.

For **Mode**, the choices are **Tx** (transmit), **Rx**, (receive) or **Both**. The default is **Both**.

8. In the **Hello** field, enter a time value in seconds.

The Hello value sets the interval between hello bridge protocol data units sent by the root switch configuration messages. The range of valid values is from 4 to 180 seconds. The default is 30 seconds.

9. In the **Multiplier** field, set the number of consecutive misses allowed before LLDP considers the interface to be down.

The range is 2 to 10. The default is 4. The multiplier is related to the Hello time interval. Using the defaults, you wait four times (the multiplier value) at 30 second intervals (the hello value) before giving up on the interface.

10. In the **FCoE Priority Bits** field, enter a value that indicates the desired user priority. Each bit represents a user priority associated with FCoE traffic.

The range of valid values is from 0 through 255. The default is 8.

Even though setting multiple bits is allowed (exercising the full range of values), it does not make sense to set more than one bit, because adapters do not support multiple priorities for FCoE.

NOTE

Web Tools accepts only decimal values for this option, but the CLI allows only entries in list format or hexadecimal. For example, if you enter the value 8 (decimal) in Web Tools, CLI represents it as 3 in list format. If you enter the value 255 (decimal) in Web Tools, CLI represents it as 0 1 2 3 4 5 6 7 in list format.

11. Select the parameters you want to exchange.

Note that the term TLV indicates packaging of parameters into a Brocade-specific Type/Length/Value (TLV):

- **Advertise Optional-tlv** -- Advertises the following optional TLVs:
 - **system-description** --Describes switch or blade characteristics.
 - **port-description** --Describes the configured port.
 - **system-name** --Specifies the system name.

- **system-capabilities** --Describes the system capabilities.
- **management-address** --The IP address of the management port.
- **Advertise dot1-tlv** --Select this check box to advertise to any attached device to send IEEE 802.1 LLDP type, length, and values.
- **Advertise dot3-tlv** --Select this check box to advertise to any attached device to send IEEE 802.3 LLDP type, length, and values.
- **Advertise DCBx-tlv** --Select this check box to advertise to any attached device the respective LLDP type, length, and values.
- **Advertise DCBx-fcoe-logical-link** --Select this check box to advertise to any attached device to send DCBX protocol over LLDP to negotiate the logical link type, length, and values.
- **Advertise DCBx-fcoe-app** --Select this check box to advertise application type, length, and values to ensure interoperability of traffic over DCBX protocol running over LLDP.

12.Click **Apply**.

13.Click **Save Configuration**.

Adding an LLDP profile

The LLDP profile determines LLDP settings per port.

To add an LLDP profile, perform the following steps.

1. Select the **DCB** tab on the **Switch Administration** window.
2. Select the **LLDP-DCBX** tab.
3. Select the **LLDP Profile** tab.
4. Click **Add**.

The **LLDP Configuration** dialog box displays.

5. Enter a name for the configuration in the **Name** field.
6. Optionally, add a description in the **Description** field.
7. Select the **Mode**.

For **Mode**, the choices are **Tx** (transmit), **Rx**(receive) or **Both**. The default is **Both**.

8. In the **Hello** field, enter a time value in seconds.

The Hello value sets the interval between hello bridge protocol data units sent by the root switch configuration messages. The range is 4 to 180 seconds. The default is the global configuration range.

9. In the **Multiplier** field, set the number of consecutive misses allowed before LLDP considers the interface to be down.

The range is 2 to 10. The default is the global configuration range. The multiplier is related to the Hello time interval. Using the defaults, you wait four times (the multiplier value) at 30 second intervals (the hello value) before giving up on the interface.

- 10.Select the parameters you want to exchange.

Note that the term TLV indicates packaging of parameters into a Brocade-specific Type/Length/Value (TLV).

- **Advertise Optional-tlv** --Advertises the following optional TLVs:
 - **system-description** --Describes switch or blade characteristics.
 - **port-description** --Describes the configured port.
 - **system-name** --Specifies the system name.

- **system capabilities** --Describes the system capabilities.
 - **management-address** --The IP address of the management port.
 - **Advertise dot1-tlv** --Advertises to any attached device to send IEEE 802.1 LLDP type, length, and values.
 - **Advertise dot3-tlv** --Advertises to any attached device to send IEEE 802.3 LLDP type, length, and values.
 - **Advertise DCBx-tlv** --Advertises to any attached device the respective LLDP type, length, and values.
 - **Advertise DCBx-fcoe-logical-link** --Advertises to any attached device to send DCBX protocol over LLDP to negotiate the logical link type, length, and values.
 - **Advertise DCBx-fcoe-app** --Advertises application type, length, and values to ensure interoperability of traffic over DCBX protocol running over LLDP.
11. Click **Save Configuration**.

Configuring DCB interfaces

The **DCB Interfaces** tab in the **Port Admin** tab is used for configuring the DCB interfaces on a switch.

To configure the DCB interfaces, perform the following steps.

1. Select the **DCB Interfaces** tab on the **Port Admin** tab.
2. Select the port you want to configure under the **DCB Interface Explorer**.
3. Select the **General** tab.
4. Click **Edit**.

The **DCB Edit Configuration** dialog box displays.

5. Select the **Interface Mode**.

The options are **None** and **L2**. The default option is **None**.

If you intend to use this port in a Link Aggregation Group (LAG), select **None**. L2 mode is applied when you configure the LAG.

6. Select the **L2 Mode**.

The choices are **Access**, **Trunk**, and **Converged**. The default choice is **Access**.

The L2 mode setting determines operation within a VLAN:

- **Access** mode allows only one VLAN association, and all frames are untagged.
- **Trunk** mode allows more than one VLAN association, and tagged frames are allowed.
- **Converged** mode interface can be Native (untagged or access) in one VLAN and it could be non-native (trunk or tagged) type in another VLAN.

7. If you are using the DCB map or a Traffic Class Map to apply QoS traffic priority, select the appropriate button, and enter the name of the map you want to use.

For a Ten Gigabit Ethernet port configured as an FCoE port, the default DCB map is applied automatically. You cannot apply the Traffic Class Map to an FCoE port.

8. Enter the profile name in the **LLDP-DCBX Profile** field for using a specific profile for the interface.
9. In the **FCOE Priority Bits** field, enter a value that indicates the desired user priority. Each bit represents a user priority that is associated with FCoE traffic.

The range is 0-255. The default is 8.

10. Assign a default class of service in the **Default CoS** field.

The default CoS range is 0-7. The default is 0.

11. Click **OK**.
12. Click **Enable** for **Status** and **LLDP Status**.

Configuring a link aggregation group

FCoE ports can be grouped to create a link aggregation group (LAG). The LAG is treated as a single interface.

To configure a LAG, perform the following steps.

1. Select the **DCB Interfaces** tab on the **Switch Administration** window.
2. Select the **Link Aggregation** tab.
3. Click **Add**.

The **Add LAG Configuration** dialog box displays.

NOTE

Only ports that you defined with an **Interface Mode** of **None** can be a **LAG Member**.

4. Click the **Add** arrow button to move the interfaces to the **Selected List**.
5. Select the **Mode**.

The choices are **Static** and **Dynamic**. **Static** mode does not use Link Aggregation Control Protocol (LACP) to negotiate and manage link aggregation. Link participation in the LAG is determined by the link's operational status and administrative state. **Dynamic** mode uses LACP. LACP allows partner systems to examine the attributes of the links that connect them and dynamically form a LAG. When you select **Dynamic** mode, the **Active** and **Passive** options are enabled:

- If you choose **Active**, your switch initiates an exchange of LACP data units.
- If you choose **Passive**, your switch waits to receive LACP data units from its partner system and then respond. **Passive** is the default behavior.

6. Select the **Type**.

Type refers to the type of trunking used by the LAG. The choices are **Standard** and **Brocade**.

7. Select the **Interface Mode**.

The options are **None** and **L2**. The default is **None**.

8. Select the **L2 Mode**.

The L2 mode setting determines operation within a VLAN:

- **Access** mode allows only one VLAN association, and all frames are untagged.
- **Trunk** mode allows more than one VLAN association, and allows tagged frames.

9. Select the operational **Status**.

The choices are **Administratively Up** and **Administratively Down**.

10. Click **OK**.

Configuring VLANs

The Virtual LAN (VLAN) capability allows multiple virtual LANs within a single physical LAN infrastructure. The physical interface must be configured as L2 prior to configuring a VLAN, either as

an individual interface, or as a LAG. Before you start the VLAN configuration procedure, you need to know which interfaces or LAGs you want to associate with each VLAN.

To configure a VLAN, perform the following steps.

1. Select the **DCB** tab on the **Switch Administration** window.
2. Select the **VLAN** tab.
3. Click **Add**.

The **VLAN Configuration** dialog box displays.

4. Specify a VLAN ID.

The format is VLAN<bridge number><ID>. In this Fabric OS release, no bridge instances are supported, so the bridge number is always 0, and the value under **Bridge** is statically defined as VLAN0. The <ID> is an integer from 1 to 3583, that must be entered in the **ID** field.

5. Select the **Native** check box to add all the converged interfaces added in the present operation as native to a VLAN.

NOTE

If you want to modify any converged interface as either native or non-native, you must first remove that particular member from that VLAN and then re-add it to the same VLAN.

6. Under the **Selection List**, click the plus sign (+) next to the **Interface** and **LAG** folders, and select individual interfaces and LAGs you want to associate with the VLAN ID.
7. Click **Add** to move the interfaces or LAGs to the **Selected List**.

Note the reminder that interfaces must be configured as L2, and that the interfaces or LAGs must be in Trunk mode to be associated with multiple VLANs, Access mode interfaces can be associated with only one VLAN, and the Converged mode interface can be Native in one VLAN and it could be non-native type in more than one VLAN.

8. Click **OK**.
9. Repeat the procedure for additional VLANs.
10. To edit the VLAN, select the detail from the table in the **VLAN** tab and click **Edit**.

NOTE

The FCoE check box is selected by default for FCoE VLAN. The FCoE check box is read-only, you must use the CLI to make any changes to the FCoE VLAN.

11. Click **OK** to enable FCoE. Clear the check box to disable FCoE.

Configuring FCoE login groups

FCoE login groups control which FCoE devices are allowed to log in to a switch or fabric.

The **FCoE Ports** window is used for configuring the FCoE ports on a switch.

To configure an FCoE login group, perform the following steps.

1. Select the **DCB** tab on the **Switch Administration** window.
2. Select the **FCoE Login Group** tab.
3. Click **New**.

The **New Login Group** dialog box displays.

4. Enter a name for the login group in the **Login Group Name** field.

5. Select the switch WWN.

The choices are:

- **Self** -- WWN of your current switch
- **Other Switch WWN**

If you choose **Other Switch WWN**, you must enter the WWN of that switch in the provided field.

6. Under **Login Member Configuration**, select either **Allow All Members** or **Allow Specific Member**.

- If you select **Allow All Members**, all devices attached to FCoE ports are allowed to log in to the switch.
- If you select **Allow Specific Member**, you can control which devices can log in, using **Member Type**, **Member PWWN/MAC**, and the **Add** and **Remove** buttons.

- a) Select **Model2** as the **Member Type**.
- b) Enter the port WWN in hexadecimal format in the **Member PWWN/MAC field**, and click **Add**.

The WWN displays under **Allowed Login Members**. If you decide a member should not be on the list, highlight the entry and click **Remove**.

7. Click **OK**.

Displaying FCoE port information

There are 24 internal FCoE Ports that bridge FC and Ethernet traffic. You can view FCoE port information from the **Port Admin** tab.

To display FCoE port information, perform the following steps.

1. Select the **FCoE Ports** tab on the **Port Admin** tab.

The initial view displays a summary of all FCoE ports on the switch as shown in the following figure.

FIGURE 50 FCoE Ports tab, Port Administration panel

Name	Type	Peer MAC Address	WWN
FCoE0	VF	00:00:00:00:00:00	20:c0:00:05
FCoE1	VF	00:00:00:00:00:00	20:c1:00:05
FCoE2	VF	00:00:00:00:00:00	20:c2:00:05
FCoE3	VF	00:00:00:00:00:00	20:c3:00:05
FCoE4	VF	00:00:00:00:00:00	20:c4:00:05
FCoE5	VF	00:00:00:00:00:00	20:c5:00:05
FCoE6	VF	00:00:00:00:00:00	20:c6:00:05
FCoE7	VF	00:00:00:00:00:00	20:c7:00:05
FCoE8	VF	00:00:00:00:00:00	20:c8:00:05

2. To view information for a specific port, right-click a port in the **FCoE Port Configuration and Management** table and select **Properties**.

Port information displays in three tabs. The **General** tab is pre-selected.

The **Connected Devices** tab displays information about devices connected to the switch as shown in the previous figure. Six columns of information are displayed:

- **Device WWN** displays the WWN of the connected device.
- **Device MAC** displays the MAC address of the connected device.
- **Connected Peer Type** displays the port type on the connected device.
- **Is Directly Connected** indicates whether or not the device is directly connected to the trunk.

- **FCoE Port MAC** displays the FCoE port MAC address.
- **Switch Port** displays the switch port WWN.

Displaying LAG information

To display LAG information, perform the following steps.

1. Select the **DCB** tab on the **Switch Administration** panel.
2. Select the **Link Aggregation** tab.

The LAG information displays.

Displaying VLAN information

To display VLAN information, perform the following steps.

1. Select the **DCB** tab on the **Switch Administration** window.
2. Select the **VLAN** tab.

The VLAN information displays.

Displaying FCoE login groups

To display FCoE login group information, perform the following steps.

1. Select the **DCB** tab on the **Switch Administration** window.
2. Select the **FCoE Login** tab.

The FCoE login group information displays.

Displaying QoS information

To display QoS information, perform the following steps.

1. Select the **DCB** tab on the **Switch Administration** window.
2. Select the **QoS** tab.

From the **QoS** tab, you can select the **DCB Map** tab to display DCB map information, or select the **Traffic Class Map** tab to display traffic class maps information.

Displaying LLDP-DCBX information

To display LLDP-DCBX information, perform the following steps.

1. Select the **DCB** tab on the **Switch Administration** window.
2. Select the **LLDP-DCBX** tab.
 - To display global settings, select the **Global** tab.
 - To display LLDP profile information, select the **LLDP Profile** tab.

Displaying DCB interface statistics

The DCB interface **Port Statistics** tab displays basic and advanced statistics, and allows you to change statistics collection parameters.

The **DCB Interface Statistics Configuration** section allows you to do the following:

- Toggle between showing **Absolute Values** or **Delta Values** (values that have changed since the last data collection).
- Use the **Clear Counters** button to clear the counters in port statistics.
- Change the retrieval interval.

To view additional information, select **View** > **Advanced Mode**. An **Advanced** tab and an **Error Detail** tab are added next to **Basic Mode**.

The **Advanced** tab displays DCB transmission statistics, and the **Error Details** tab displays transmission error statistics.

To display DCB interface statistics, perform the following steps.

1. Select the **DCB Interfaces** tab on the **Port Admin** tab.
2. Under the **DCB Interface Explorer**, select a port.
3. Select the **Port Statistics** tab.

Configuring a DCB interface from the Switch View

DCB interfaces can be enabled and disabled from a right-click menu on the **Switch View**.

To enable or disable a DCB interface from the **Switch View**, perform the following steps.

1. Right-click the port to display the right-click menu.
2. Select **Configure** to display the **Enable** and **Disable** options.

Configuring a DCB interface from the Port Admin panel

DCB interfaces can be enabled and disabled from the **Port Admin** tab.

To enable or disable a DCB interface from the **Port Admin** tab, perform the following steps.

1. Select the **DCB Interfaces** tab on the **Port Admin** tab.
2. Under the **DCB Interface Explorer**, select the port you want to enable or disable.
3. Select the **General** tab.

You can follow either of the following options to enable or disable the interface:

- Select **Enable** or **Disable** from the **Interface** list to enable or disable the interface.
- Click **Edit Configuration** to open the **DCB Edit Configuration** dialog box. Select **Enable** or **Disable** for the **Status** field to enable or disable the interface.

Enabling and disabling a LAG

To enable or disable a LAG, perform the following steps.

1. Select the **DCB** tab on the **Switch Administration** window.
2. Select the **Link Aggregation** tab.
3. Click **Add**.

The **LAG Configuration** dialog box displays.

4. Change the **Status** to **Administratively Up** or **Administratively Down**.

Enabling and disabling LLDP

To enable or disable LLDP on a DCB interface, perform the following steps.

1. Select the **DCB Interfaces** tab on the **Port Admin** tab.
2. Under the **DCB Interface Explorer**, select the port.
3. Select the **General** tab.
4. Select **Edit** from the **Actions** list.

The **DCB Edit Configuration** dialog box displays.

5. For the **LLDP Status** option, select **Enable** or **Disable**.

Enabling and disabling QoS priority-based flow control

Priority-based flow control (PFC) can be used to control network congestion. PFC can be used to selectively pause lower priority traffic classes to ensure that high priority and delay-sensitive traffic are not affected by network congestion. For example, if a large storage transfer is monopolizing the network and causing congestion, PFC can be used to pause the storage transfer so other traffic may use the network.

To enable or disable PFC, perform the following steps.

1. Select the **DCB** tab on the **Switch Administration** window.
2. Select the **QoS** tab.
3. Select the **DCB Maps** tab.
4. Under the **Priority Group area**, enable or disable **Priority Flow Control Status** option for each **Priority Group ID**.

Enabling and disabling FCoE ports

You can enable and disable FCoE Ports individually from the **Port Admin** tab.

1. Select the **FCoE Ports** tab on the **Port Admin** tab.
2. Select the port you want to enable or disable under the **FCoE Ports Explorer**, or from the list.
3. Select **Enable / Disable** > **Enable** or **Disable** from the **Actions** list to change the current status of the port.

You can also enable or disable the FCoE ports by selecting **Edit** from the **Actions** list and selecting **Enable** or **Disable** on the **FCoE Edit Configuration** dialog box.

Limitations

- [General Web Tools limitations](#)..... 261

General Web Tools limitations

The following table lists general Web Tools limitations that apply to all browsers and switch platforms.

TABLE 24 Web Tools limitations

Area	Details
Blade Failure	If a blade fails on the switch, the Web Tools interface can still display slot and ports as healthy. In this case, the failure might not be visible in Web Tools until the Web Tools window is reopened.
Browser	For Internet Explorer 7.0, the default setting is to disable Telnet functionality. You must make the appropriate changes in the registry to enable Telnet functionality if you want to use it. Launching the default Telnet is not supported in Windows Vista and Windows 2008 server.
Browser	Fabric Watch, Switch Admin, HA, Name Server, and Zone Admin are separate applets embedded in HTML pages. The successful launch of the applet depends on whether the browser can successfully load the HTML page. Very occasionally, a blank browser window displays with the message "loading pages..." that is stuck. This is likely caused by a sudden loss of switch Web server (either by normal HA failover, restart, or other causes). Workaround: If Fabric Watch, Switch Admin, HA, Name Server, or Zone Admin hang, close this window and relaunch the module.
Browser	A Web Tools browser window might stop responding following an HA failover immediately after a zoning configuration was enabled or disabled. It is likely that the Web daemon was terminated by the HA failover before the HTTP request was sent back. Workaround: If one of the Web Tools modules is hanging, close the window and relaunch the module. If the module is locked, shut down and relaunch the Web Tools application.
Browser	When you launch Fabric Watch , Switch Admin , Name Server , and Topology from Switch Explorer through Internet Explorer, the applet windows cannot be resized and the Maximize button is disabled.
Chassis not ready for management	If the switch is still in the process of booting and you try to launch the Web Tools by entering the IP address, this message displays in the browser. You should wait for the switch to finish the startup sequence.
Configuration	Web Tools does not support NAT router configurations and does not function correctly with switches behind a NAT router.

TABLE 24 Web Tools limitations (Continued)

Area	Details
Firmware download	<p>There are multiple phases to firmware download and activation. When Web Tools reports that firmware download completed successfully, this indicates that a basic sanity check, package retrieval, package unloading, and verification was successful.</p> <p>Web Tools forces a full package install.</p> <p>A restart is required to activate the newly downloaded firmware. This restart is done automatically; however, although Web Tools windows continue to display during the restart, they are not available. Wait approximately 10 minutes to ensure that all of the application windows are restored. If Web Tools fails to respond after 20 minutes, you might need to close all Web Tools applications windows and restart them, or to contact your system administrator for network assistance.</p> <p>The Web Tools loss of network connectivity during a failover or restart (initiated through the firmwareDownload) varies for different configurations:</p> <p>Brocade DCX and DCX-4S enterprise-class platforms: Loss of network connectivity is up to 5 minutes if the power-on self-test (POST) is disabled. If POST is enabled, the loss of network connectivity can exceed 5 minutes.</p> <p>Brocade 300, 5100, 5300, 6510, 6520, 7800, 7840, VA-40FC, and the Encryption Switch: Loss of network connectivity is up to 1 minute if POST is disabled. If POST is enabled, the loss of network connectivity can exceed 1 minute.</p>
Firmware downgrade	<p>If you try to run Web Tools on a switch after downgrading the firmware, Web Tools may not open. This is due to the presence of old application cache files in Java. The workaround is to delete the application cache files using the Java Control Panel.</p> <p>After upgrading or downgrading the firmware, delete the application cache files.</p>
HTTP timeout	<p>Occasionally, you might see the following message when you try to get data from a switch or to send a request to the switch:</p> <p>Failed to get switch response. Please verify the status of your last operation and try again if necessary.</p> <p>This indicates that an HTTP request did not get a response. The request was sent to the switch, but the connection was down, probably caused by a temporary loss of the Web server on the switch. Due to the nature of an HTTP connection, Web Tools reports this error after a 90-second default timeout.</p> <p>In this case, verify the status of your last request, using Telnet to check related status, or click the Refresh button from the Web Tools application you were working on to retrieve related data. If your request did not get through to the switch, resubmit it. Executing a refresh from Web Tools retrieves a copy of switch data at that moment; the data you entered can be lost if it had not already committed to the switch.</p>
In-band management support	<p>Fabric OS v7.3.0 supports Web Tools, SNMP polling, and SNMP traps only in IPv4 on the Brocade 7800 and FX8-24.</p>
Java cache	<p>If the Web Tools progress bar stops at 93 percent when initializing switch details, you must clear the Java cache, as described in Deleting temporary Internet files used by Java applications on page 25.</p>

TABLE 24 Web Tools limitations (Continued)

Area	Details
Java Plug-in	<p>If you have a Web Tools session open and you open a second session using the File > New browser menu, this results in unexpected behavior of the original Web Tools session. For example, you cannot change Admin Domains in the second session.</p> <p>Web Tools supports only one browser instance per JRE, and when you open another window using the File > New menu, the two windows share the same JRE environment.</p> <p>Workaround: Open two independent browser sessions.</p>
Loss of Connection	<p>Occasionally, you might see the following message when you try to retrieve data from the switch or send a request to the switch:</p> <p>Switch Status Checking</p> <p>The switch is not currently accessible.</p> <p>The dialog box title may vary, because it indicates which module is having the problem.</p> <p>This is caused by the loss of HTTP connection with the switch, due to a variety of possible problems. Web Tools automatically tries to regain the connection. While Web Tools is trying to regain the connection, check if your Ethernet connection is still functioning. If the problem is not with the Ethernet connection, wait for Web Tools to recover the connection and display the following message:</p> <p>"You will have to resubmit your request after closing this message."</p> <p>If the temporary switch connection loss is caused by a switch hot code load or other similar operation, the Switch Explorer you are currently running can be downloaded from a different firmware version than the new one. In this case, the following message displays:</p> <p>"Switch connection is restored. The firmware version you are running is not in sync with the version currently on switch. Close your browser and re-launch Web Tools."</p> <p>You need to close Switch Explorer and relaunch Web Tools to reopen the connection.</p> <p>Launching Web Tools takes around 5 minutes when the machine where client is running does not have access to internet. This is due to the certificate revocation check for the web start applications.</p> <p>Workaround: Go to Java Control Panel > Advanced > and select Do no check (not recommended) under Perform certificate revocation checks on to skip certificate revocation check for web start applications.</p>
Non-FIPS secure mode HTTPS	<p>HTTPS supports only TLSv1 and SSLv3 protocols with !DH:HIGH:-MD5 cipher in non-FIPS mode. These options must be enabled in your Internet browser.</p>
Out of Memory Errors	<p>If you are managing fabrics with more than ten switches or more than 1000 ports, or if you are using the iSCSI Gateway module extensively, you might encounter out-of-memory errors such as the following:</p> <p>java.lang.OutOfMemoryError: Java heap space</p> <p>To avoid this problem, increase the default heap size in the Java Control Panel. Refer to Java Plug-in configuration on page 27 for instructions.</p>
Performance Monitor	<p>If the web browser crashes or the Performance Monitor license is lost while the Performance Monitoring window is running, some of the Performance Monitor resources owned by Web Tools might not be cleaned up correctly.</p> <p>Workaround: You might need to use the CLI to manually delete these counters. For example, if you detect Web Tools owned resources (using perfshoweemonitor), but you have verified that no Web users are actually using them, use the perfdeleemonitor or perfcleareemonitor command to free the resources.</p>

TABLE 24 Web Tools limitations (Continued)

Area	Details
Performance Monitor	<p>The Switch Throughput Utilization, Switch Percent Utilization, and Port Snapshot Error graphs display the faulty/powerd off slot node in the Y-Axis of the graph.</p> <p>Workaround: Launch any port selection dialog box and load the graphs accordingly.</p>
Refresh option in browsers	<p>When a window requesting a user response is pushed into the background and a refresh is requested, a fatal Internet Explorer error might occur.</p> <p>Workaround: Restart the browser.</p>
Refresh option in browsers	<p>Web Tools must be restarted when the Ethernet IP address is changed using the NetworkConfig View command. Web Tools appears to hang if it is not restarted after this operation is executed.</p> <p>Workaround: Restart the browser.</p>
Refresh option in browsers	<p>If you change the switch name or domain ID using the CLI after the Web Tools Switch Administration window has started, the new switch name or domain ID is not updated on the header of the Switch Administration page. Clicking the Refresh button does not fix the problem.</p> <p>Workaround: Click the Switch tab and the Switch Administration header updates.</p>
Refresh option in browsers	<p>If you change the switch name using the Web Tools Switch Administration page or SNMP and then open a Telnet window to verify the name change, the CLI prompt (for example, switch:admin >) displays the previous name. The Telnet prompt cannot pick up the new switch name until the switch is fastbooted.</p> <p>Workaround: In order to display the correct switch name in the CLI prompt after a switch name update using Web Tools or SNMP, fastboot the switch.</p>
Refresh option in browsers	<p>Following a switch enable or disable, you must wait at least 25 to 30 seconds for the fabric to reconfigure and for FSPF route calculations to complete before requesting routing information. If accessed too early, routing information are not shown.</p> <p>Workaround: Following a switch enable or disable, wait at least 25-30 seconds before further action.</p>
Refresh option in browsers	<p>The Web Tools Switch Explorer might continue to display a switch from the Switch View , even when the switch has been removed from the fabric.</p> <p>Workaround: If this behavior is seen, relaunch Switch Explorer. If the switch was removed from the fabric, the Fabric View window lists the switch as unavailable.</p>
Refresh option in browsers	<p>In the Switch Administration window, Switch tab, if you click the Refresh button, you might not be able to click the data entry fields to enter text. This behavior occasionally happens on a notebook or laptop computer; it rarely happens on a desktop computer.</p> <p>Workaround: If this happens, you should close the browser window and restart it.</p>
Switch Explorer closure	<p>If a session times out or you exit or close the Switch Explorer window, all other windows belonging to the session are invalidated. After a short delay these windows become unusable, but are not closed automatically. You must manually close these windows.</p>
Switch View	<p>Occasionally, switches might display the port icons correctly, but be missing one or more control button icons.</p> <p>Workaround: Close the Switch View of the switch and reopen it.</p>

TABLE 24 Web Tools limitations (Continued)

Area	Details
Windows Operating Systems	Occasionally, you will not see the "Lost connection to the switch" message on the Switch View , even though the Ethernet connection has been lost. You might still be able to invoke various features from Switch View , such as Status , Fan Temp , Power , and Beacon . Workaround: Verify Ethernet connection to the switch by pinging the logical switch IP address.

Index

2 domain/4 domain fabric licenses [28](#)
7800 switch [104](#), [105](#)

A

access control. Refer to RBAC. [32](#)
Access Control List. Refer to ACL [209](#)
Access Gateway mode
 configuration [175](#)
 disable [177](#)
 enable [177](#)
 F_Port trunk groups [123](#)
accessing switch event report [72](#)
activating
 Allow / Prohibit Matrix configuration [242](#)
 licenses [67](#)
 Ports on Demand [106](#)
adding
 performance graphs to a canvas [137](#)
 zone alias members [146](#)
 zone configuration members [152](#)
 zone members [148](#)
Admin Domains
 assigning administrators [202](#)
 creating [90](#)
 deleting [93](#)
 direct port membership [96](#)
 indirect port membership [96](#)
 opening [87](#)
 to activate/deactivate [92](#)
Admin Domain window
 closing [90](#)
 refreshing [89](#)
aliases, zone. Refer to zone aliases [146](#)
all access zoning [140](#)
Allow / Prohibit Matrix configuration
 displaying [243](#)
Allow / Prohibit Matrix configuration
 activating [242](#)
 copying [243](#)
 deleting [243](#)
 displaying [241](#), [244](#)
arbitrated loop parameters, configuring [65](#)
automatic trace dump transfers [160](#)
auto-negotiate port speed [101](#)

B

backbone fabric ID, configuring [173](#)
backing up configuration file [79](#)
basic performance monitoring graphs [130](#), [131](#)
BB credit [63](#)
beaconing, enabling [75](#)
best practices for zoning [158](#)
blades, enabling and disabling [56](#)
browsers
 limitations [261](#)
 refresh frequency, setting [24](#)
 supported [23](#)
buffer-limited ports [187](#)

C

changing
 domain ID [59](#)
 passwords [204](#)
 switch name [59](#)
class F traffic [63](#)
clearing temporary internet files [25](#)
clearing the zoning database [157](#)
closing
 Admin Domain window [90](#)
 sessions [32](#)
code page, displaying [239](#)
configuration
 Access Gateway mode [175](#)
 upload [177](#)
configuration file
 Admin Domain considerations [81](#)
 backing up [79](#)
 restoring [80](#)
configuring

- Allow / Prohibit Matrix [240](#)
- arbitrated loop parameters [65](#)
- backbone fabric ID [173](#)
- default heap size [27](#)
- EX_Ports [170](#)
- fabric parameters [63](#)
- FAN frame notification parameters [65](#)
- FC ports [99](#)
- FCR router cost [172](#)
- FICON Management Server parameters [237](#)
- IOD frames delivery [194](#)
- Java Plug-in [27](#)
- link cost [194](#)
- long-distance settings [189](#)
- ports [95](#)
- port speed [99](#)
- port type [99](#)
- RADIUS server [218](#)
- routes [191](#)
- syslog IP address [54](#)
- system services [66](#)
- virtual channel settings [64](#)
- configuring FCR router port costs [172](#)
- Control Device state [239](#)
- Control Unit Port. Refer to CUP [235](#)
- copper GigE [104](#), [105](#)
- copying Allow / Prohibit Matrix configuration [243](#)
- CP failover, initiating [71](#)
- creating
 - Admin Domains [90](#)
 - basic performance graphs [130](#)
 - SCC/DCC policy [209](#)
 - SCSI command graphs [134](#)
 - SCSI vs. IP traffic graphs [134](#)
 - SID-DID performance graphs [133](#)
 - zone aliases [146](#)
 - zone configurations [151](#)
 - zones [148](#)
- creating FCS policy [209](#)
- customizing basic performance graphs [131](#)

D

- datafield size [63](#)
- default zoning [140](#)
- deleting

- Admin Domains [93](#)
- Allow / Prohibit Matrix configuration [243](#)
- user accounts [202](#)
- zone aliases [147](#)
- zone configurations [153](#)
- zones [149](#)
- device probing [63](#)
- devices only viewzones
 - selecting a view [145](#)
- devices only zoning [145](#)
- direct port membership in Admin Domains [96](#)
- disabling
 - Access Gateway mode [177](#)
 - automatic trace uploads [160](#)
 - blades [56](#)
 - dynamic load sharing [193](#)
 - FICON Management Server mode [237](#)
 - ports [104](#), [105](#)
 - RADIUS [218](#)
 - RLS probing [66](#)
 - switch [58](#)
 - trunking mode [121](#)
 - zone configurations [154](#)
 - zoning [154](#)
- displaying
 - Allow / Prohibit Matrix configuration [241](#), [243](#), [244](#)
 - Control Device state [239](#)
 - enabled zone configuration [154](#)
 - fan status [162](#)
 - FICON code page [239](#)
 - name server entries [74](#)
 - power supply status [163](#)
 - switch events [72](#)
 - temperature status [162](#)
 - user account information [199](#)
- DLS [193](#)
- domain ID, changing [59](#)
- downloading
 - configuration file [80](#)
 - firmware [82](#)
- Dynamic Load Sharing. Refer to DLS [193](#)

E

- E_D_TOV [63](#)
- edge fabrics [167](#)
- editing port [178](#)
- EGM licensed features
 - FICON CUP [235](#)
 - Performance Monitoring [37](#)
- enabled zone configuration, displaying [154](#)
- enabling

- Access Gateway mode [177](#)
- automatic trace dump transfer [160](#)
- beaconing [75](#)
- blades [56](#)
- DLS [193](#)
- FICON Management Server mode [237](#)
- insistent domain ID mode [64](#)
- ports [104](#)
- Ports on Demand [106](#)
- RADIUS [218](#)
- RLS probing [66](#)
- switch [58](#)
- trunking mode [121](#)
- zone configurations [153](#)

ending sessions [32](#)

events

- displaying [72](#)
- filtering [72](#)
- severity levels [71](#)

EX_Ports, configuring [170](#)

exchange-based routing [191](#), [193](#)

expiring passwords [205](#)

extended fabrics [187](#)

F

F_Port trunk groups

- Access Gateway mode [123](#)

fabric ID, configuring [173](#)

fabric information, refreshing [89](#), [144](#)

fabric parameters, configuring [63](#)

Fabric Tree [40](#)

fabric view [145](#)

fabric view zoning [145](#)

Fabric Watch

- about [185](#)

failover, initiating [71](#)

FAN frame notification parameters, configuring [65](#)

fan status [162](#)

fast boot [61](#)

FC-FC routing

- about [167](#)
- setting up [168](#)
- supported switches [168](#)

FC ports, configuring [99](#)

FC Routing module [169](#)

FCR router cost [172](#)

FCS policy

- activate [210](#)
- create [209](#)
- deactivate [210](#)
- delete [210](#)
- distribute [211](#)
- moving switch position [211](#)

feature licenses [67](#)

FICON Management Server

- mode, enabling and disabling [237](#)
- parameters [237](#)

filtering events [72](#)

Filtering IP Addresses [55](#)

firmware download [82](#)

FSPF routing [192](#)

fwdl. Refer to firmware download. [82](#)

G

GigE

- media type [104](#), [105](#)

graphs for performance monitoring [126](#)

GUI

- preferences [39](#)

H

HA. Refer to High Availability [69](#)

hard zones [145](#)

heap size, configuring [27](#)

High Availability [69](#)

HTTPS protocol [29](#), [261](#)

I

ID_ID mode

- about [63](#)
- enabling [64](#)

inactivity timeout [33](#)

indirect port membership in Admin Domains [96](#)

initiating CP failover [71](#)

in-order delivery. Refer to IOD [194](#)

insistent domain ID mode

- about [63](#)
- enabling [64](#)

installing

- Java Plug-in [26](#), [27](#)
- JRE [26](#)
- JRE patches on Solaris [26](#)
- Solaris patches [26](#)

Internet Explorer 7.0 [48](#)

IOD, frame delivery [194](#)

IP address
 filtering [55](#)
ISL trunking [121](#)

J

Java Plug-ins
 configuring [27](#)
 installing [26](#), [27](#)
 supported [23](#)
JRE, installing [26](#)

L

launching
 FC Routing module [169](#)
 Web Tools [29](#)
LEDs, port [166](#)
licensed features [67](#)
licenses
 activating [67](#)
 removing [68](#)
limitations
 browsers [261](#)
 firmware download [261](#)
 HTTP [261](#)
 Microsoft Windows Operating System [261](#)
 Performance Monitor [261](#)
 Switch View [261](#)
limited switch license [28](#)
link cost [194](#)
logging out [32](#)
LSAN
 devices [172](#)
 fabrics, managing [170](#)
 zones, managing [172](#)

M

managing RADIUS server [217](#), [220](#), [221](#)
media type
 GigE [104](#), [105](#)
message severity levels [71](#)
MetaSAN [167](#)
modifying

 performance graphs [137](#)
 RADIUS server [219](#)
 RADIUS server order [219](#)
 zone aliases [146](#)
 zone configurations [152](#)
 zones [148](#)
monitoring performance [125](#)
mouse over information [45](#)

N

name server entries, displaying [74](#)
naming ports [103](#)
no access zoning [140](#)
Non DFE [97](#)
non-FIPS [261](#)
NPIV ports
 disable [106](#)
 enable [106](#)

O

opening
 Performance Monitoring window [130](#)
 Switch Administration window [52](#)
optical GigE [104](#), [105](#)

P

passwords
 changing [204](#)
 expiring [205](#)
 rules [204](#)
 unlocking [205](#)
performance graphs
 adding to a canvas [137](#)
 modifying [137](#)
 printing [137](#)
 types of [126](#)
Performance Monitoring window [130](#)
per-frame routing priority [63](#)
persistently disable a port [105](#)
platforms, supported [23](#)
polling rates [46](#)
port-based routing [191](#)
port membership in Admin Domains [96](#)
port menu [45](#)
port names, assigning [103](#)
ports

- buffer-limited [187](#)
- configuring [95](#)
- disabling [104](#), [105](#)
- enabling [104](#)
- LEDs [166](#)
- long distance parameter [189](#)
- naming [103](#)
- Ports on Demand, enabling [106](#)
- port speed, configuring [99](#)
- port speed configuration [101](#)
- port swapping [111](#)
- port type, configuring [99](#)
- power supply status [163](#)
- preferences
 - persist [39](#)
- printing
 - effective zone configuration [155](#)
 - performance graphs [137](#)
- protocol options [261](#)

R

- R_A_TOV [63](#)
- RADIUS server
 - about [217](#), [220](#), [221](#)
 - configuring [218](#)
 - enabling and disabling [218](#)
 - modifying [219](#)
 - modifying server order [219](#)
 - removing [220](#)
- RAM requirements [23](#)
- RBAC, pre-defined roles [32](#)
- rebooting the switch [61](#)
- recommendations
 - configuration tasks [47](#)
 - for Web Tools [47](#)
 - for zoning [158](#)
- recommended buffer calculation [103](#)
- refresh frequency, setting [24](#)
- refreshing
 - Admin Domain window [89](#)
 - fabric information [89](#), [144](#)
 - Zone Admin window [144](#)
- refresh rates [46](#)
- remaining buffer calculation [103](#)
- removing
 - licenses [68](#)
 - RADIUS server [220](#)
 - zone alias members [146](#)
 - zone configuration members [152](#)
 - zone members [148](#)
- renaming

- zone aliases [147](#)
- zone configurations [152](#)
- zones [149](#)
- replacing a WWN in zoning database [156](#)
- requirements, Web Tools [23](#)
- restoring configuration file [80](#)
- right-click menu [45](#)
- RLS probing, enabling and disabling [66](#)
- Role-Based Access Control. Refer to RBAC [32](#)
- router cost path [172](#)
- routes, configuring [191](#)

S

- saving
 - performance graphs [136](#)
 - zoning changes [90](#), [145](#)
- SCC/DCC policy
 - activate [210](#)
 - create [209](#)
 - deactivate [210](#)
 - delete [210](#)
 - edit [210](#)
- SCSI command graph [134](#)
- SCSI vs. IP traffic graph [134](#)
- searching zone member selection lists [157](#)
- secure file transfer protocol [80](#)
- sequence level switching [63](#)
- session management [33](#)
- sessions, ending [32](#)
- setting
 - refresh frequency [24](#)
 - SNMP trap levels [215](#)
- severity levels [71](#)
- SID-DID performance graph [133](#)
- SNMP trap levels [215](#)
- Solaris patches, installing [26](#)
- SSLv3 [261](#)
- starting Web Tools [29](#)
- swapping port index IDs [111](#)
- switch
 - 7800 [104](#), [105](#)
 - changing the name of [59](#)
 - enabling and disabling [58](#)
 - mouse over information [45](#)
 - rebooting [61](#)
 - Switch Administration window

- opening [52](#)
- switch events, displaying [72](#)
- Switch Events and Switch Information [43](#)
- Switch Explorer, Admin Domains [41](#)
- switch name, changing [59](#)
- switch report [60](#)
- switch status report [163](#)
- Switch View [41](#)
- Switch View buttons [41](#)
- syslog IP address
 - configuring [54](#)
 - removing [55](#)
- system services, configuring [66](#)

T

- Telnet [48](#)
- temperature status [162](#)
- temporary internet files [25](#)
- timeout, session [33](#)
- TLS [261](#)
- trace dumps [159](#)
- transition, partial Web Tools functions to Brocade Network Advisor [21](#)
- troubleshooting
 - Web Tools [47](#)
- trunking mode, enabling and disabling [121](#)

U

- unlocking passwords [205](#)
- user accounts, managing [197](#)
- user-defined roles
 - guidelines and restrictions [206](#)

V

- value line licenses [28](#)
- VC Priority [64](#)
- viewing
 - EX_Ports [170](#)
 - LSAN devices [172](#)
 - LSAN fabrics [170](#)
 - LSAN zones [172](#)
 - swapped ports [111](#)
 - Switch Explorer [37](#)
 - switch status [163](#)
- viewing FCR router cost [172](#)
- virtual channel settings, configuring [64](#)

W

- Web Tools
 - Access Gateway mode, enable [177](#)
 - enabling Dynamic POD [108](#)
 - GUI preferences [39](#)
 - launching [29](#)
 - partial function transition to Brocade Network Advisor [21](#)
- WWN
 - adding to zones [155](#)
 - removing from zones [156](#)
 - replacing in zones [156](#)

Z

- Zone Admin module, saving changes [90](#)
- Zone Admin window
 - about [141](#)
 - refreshing [144](#)
 - saving changes [145](#)
- zone aliases
 - creating [146](#)
 - deleting [147](#)
 - description [146](#)
 - modifying [146](#)
 - renaming [147](#)
- zone configurations
 - creating [151](#)
 - deleting [153](#)
 - disabling [154](#)
 - enabling [153](#)
 - example [151](#)
 - modifying [152](#)
 - renaming [152](#)
- zone member selection lists, searching [157](#)
- zones
 - about [139](#)
 - adding WWNs [155](#)
 - best practices [158](#)
 - creating [148](#)
 - deleting [149](#)
 - description [148](#)
 - LSAN [172](#)
 - modifying [148](#)
 - removing WWNs [156](#)
 - renaming [149](#)
 - replacing WWNs [156](#)
- zoning

- all access [140](#)
- default zoning [140](#)
- no access [140](#)
- zoning, disabling [154](#)
- zoning, saving changes [90](#), [145](#)
- zoning database
 - clearing [157](#)
 - maximum size [145](#), [153](#)
- zoning views [145](#)

